

**D-2000 Series (Wire-to-Board, Wire-to-Panel and Wire-to-Wire)**

**List of Products by Application**

D-2000 Series connectors are the next smallest in Dynamic Series, yet they can meet requirements of connectors for most industrial applications. They can be used

mainly for signal applications. Signal lines under 250 V are of 2.5 mm pitch, which can accept 18 AWG wires. (5 A max. per position)

D-2000 Series have several unique characteristics such as center-lock method for effective use of PCB properties, contact-entrance method for low profile shapes, and others.

D-2000 Series

**D-2100S  
1-Row Type**

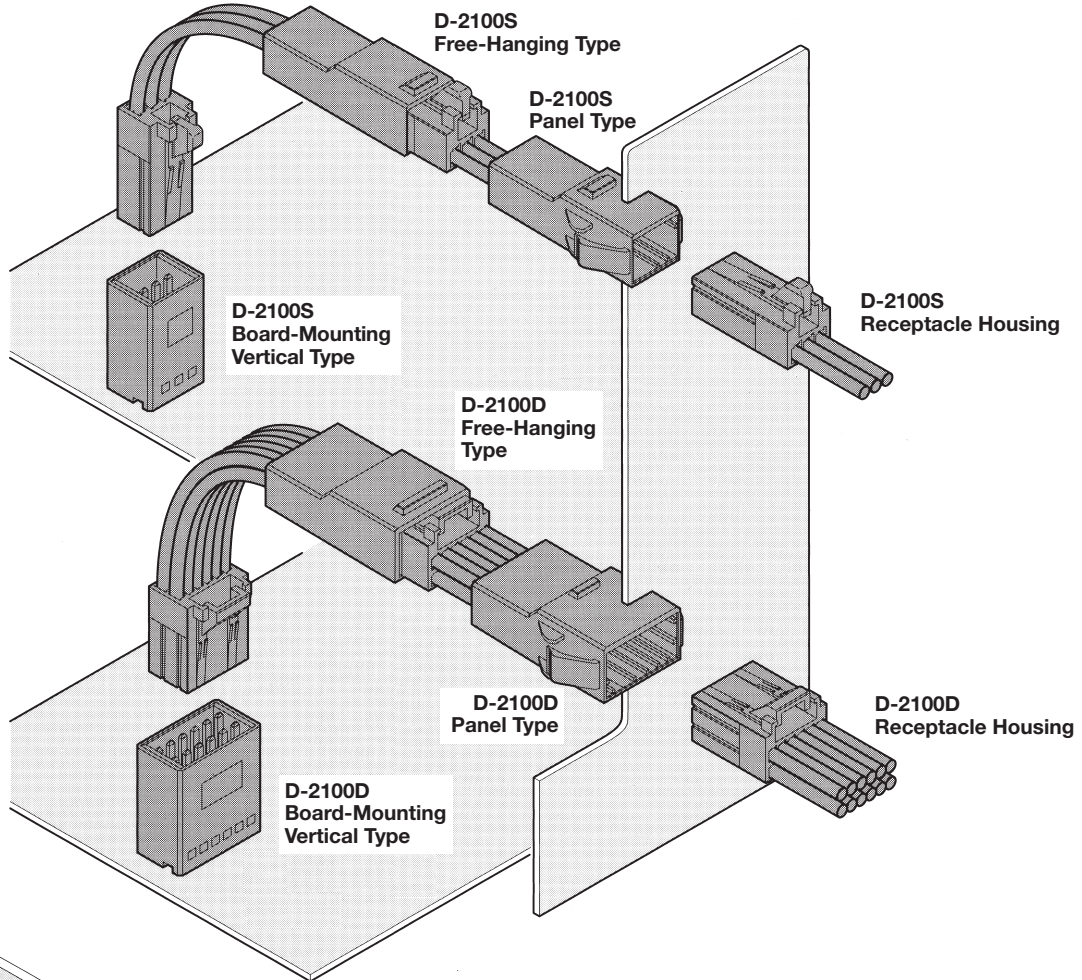

**D-2100D  
2-Row Type**

**D-2100M  
Drawer Type**

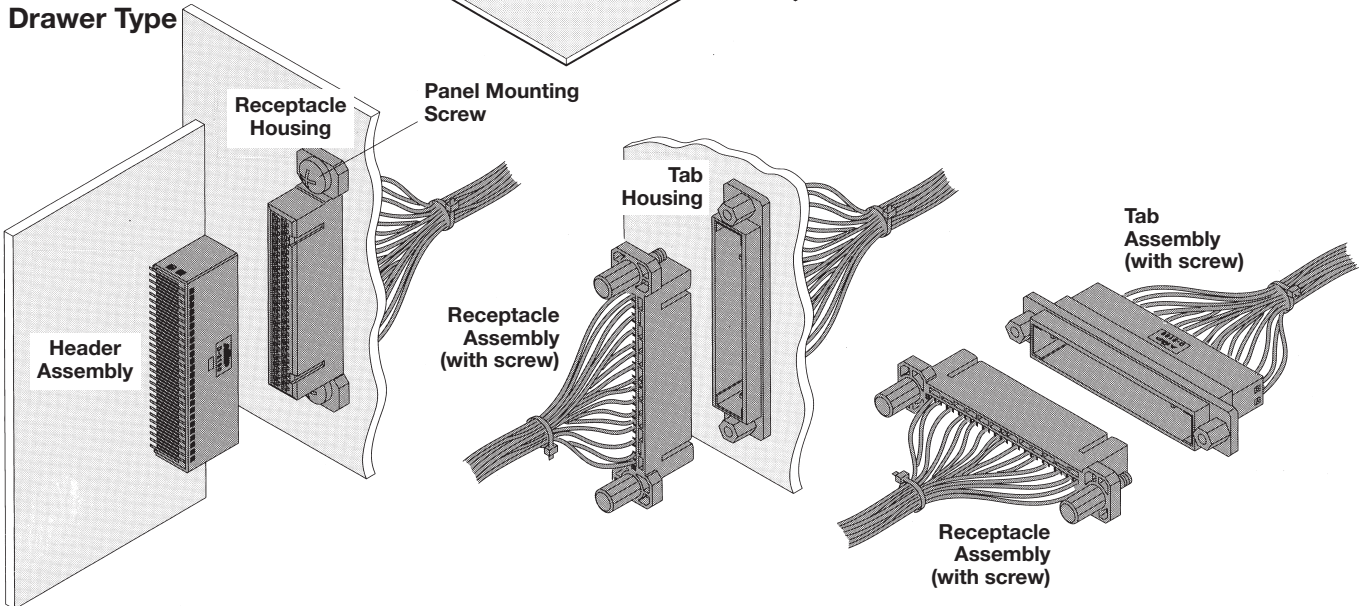

**D-2000 Series** (Continued)

**Performance Specifications**

Item	Pitch	2.5mm
Voltage Rating		250 VAC
Current Rating		1-position : 5A 3-position : 5A 6-position : 5A 8-position : 4.5A 12-position : 4A 20-position : 3.2A (when using #18 AWG wire)
Contact Resistance		10 mΩ max.
Dielectric Withstanding Voltage		1,500 V (1minute)
Operating Temperature		-55° ~ +105°C

\*When connectors are used singly.

**Material and Finish**

Description	Material	Finish
<b>Receptacle contact</b> <b>Tab contact</b>	Copper alloy	Contact area 0.38 μm min. gold plating underplated nickel
<b>Tab post</b>	Copper alloy	Contact area 0.38 μm min. gold plating — Contact tail tin plated underplated nickel
<b>Housing</b>	UL94V-0 rated glass filled polyester (PBT)	

**D-2000 Series** (Continued)

**Performance Specifications**

(Continued)

**Specifications and Instruction Sheet**
**Instruction Sheet-Hand Tools**
**Specifications and Instruction Sheet**

<b>Product Specification</b>	108-5619, 108-5659 (Drawer Type)
<b>Testing Report</b>	501-5261
<b>Application Specification</b>	114-5258
<b>Instruction Sheet-Extraction Tool</b>	411-5900

**Instruction Sheet-Manual Tool**

<b>Tool Part No.</b>	<b>IS No.</b>
<b>91576-1</b>	408-8547
<b>91595-1</b>	408-8547

\*Remember to obtain Instruction Sheets when you choose to use these tools.

 Extraction Tool **Part Number: 1276716-1 (411-5900)**

 Keying Plug **Part Number: 641994-1**

 Tab Contact Cutting Tool **Part Number: 919041-2**
**Safety Specifications**

The safety specifications listed below are approved on specific part numbers. Contact our Sales Department to check if the part numbers you use are approved or not. Keep in mind that there are instances where values differ from those given by Tyco Electronics Specifications.

<b>Series</b>	<b>D-2100 Series</b>			<b>D-2100M Drawer Type</b>		
	<b>Voltage Rating</b>	<b>Current Rating</b>	<b>Temperature Rating</b>	<b>Voltage Rating</b>	<b>Current Rating</b>	<b>Temperature Rating</b>
<b>Specifications</b> 108-5619 (Standard) 108-5659 (Drawer Type)	250 V	5A (1 position)	-55° to +105°C	250 V	2.6A (with #20 AWG) 50 position	-55° to +105°C
<b>UL File No. E28476</b>	Determined by requirements of equipment in use.	Determined by requirements of equipment in use.	—			
<b>CSA Report No. LR7189</b>	250 V	#24~28 AWG : 3.3A #18~22 AWG : 5A	—			
<b>TÜV License No. R 9950679</b>	125 V	5A	-55° to +105°C			

**D-2000 Series** (Continued)

**D-2 Contact and Application Tooling**

**Crimp Type**

(Gold plating : 0.38 μm)

**Receptacle Contact**

(Used on Receptacle Housing)

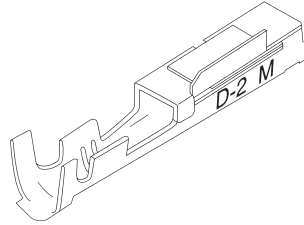

**Tab Contact**

(Used on Tab Housing)

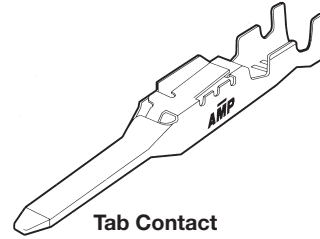

Wire Range		Wire Ins. Diameter	Wire Range Mark	Contact Part Number*		Application Tooling Part Number		
AWG	mm <sup>2</sup>			Receptacle Contact	Tab Contact	Mini-Applicator**	Hand Tool	
28	0.08	0.88~1.5	S	ST.	<b>1318106-1</b>	<b>1318110-1</b>	**	—
26	0.12			LP.	<b>1318108-1</b>	<b>1318112-1</b>	**	<b>91576-1</b>
24	0.20	1.11~1.87	M	ST.	<b>1318105-1</b>	<b>1318109-1</b>	**	—
22	0.30			LP.	<b>1318107-1</b>	<b>1318111-1</b>	**	<b>91595-1</b>
20	0.50							
18	0.85							

\* Strip Form contacts are for use with Mini-Applicators (automachines) and Loose-Piece contacts are for Hand Tools.

\*\*Mini-Applicators are for use with automachines. (For part numbers, contact Technical Support.)

**Application Tooling**

**AMP-3K/40 and AMP-5K/40 Terminating Machines**

The AMP-3K/40 and AMP-5K/40 Terminators are designed for customers that require the increased output and quality of a semiautomatic machine at a competitive price. By incorporating the most commonly requested features as standard and offering a long list of optional equipment, these terminators offer flexibility to meet the specific needs of various applications at the lowest possible cost.

- 3,000 lb. [1361 kg] max. crimp force (AMP-3K/40)
- 5,000 lb. [2268 kg] max. crimp force (AMP-5K/40)
- Toolless removal of applicators and guards
- Jog capability
- Quiet, fast operation — 80/76 dBA and cycle time less than 0.400 seconds
- Accepts Heavy Duty Mini style applicators
- Wide range of optional equipment such as toolless precision crimp height adjust, batch counter, CQM capability and work light
- Order Catalog 1654856 for specifications and part numbers

**Hand Tool**

The crimping section incorporates Straight Action construction for improved reliability as with automachine.



**Part No. :**

See the chart above.

**Minimum order quantity : 1**



**Mini-Applicator**

**Part Number :** Contact Technical Support

**Minimum order quantity : 1**



**D-2000 Series** (Continued)

**D-2100S**

**Appearance** Board mounting pitch: 2.5mm  
 Dielectric Withstanding Voltage: 1,500V (for one minute)  
 Voltage Rating: 250 VAC

D-2000 Series

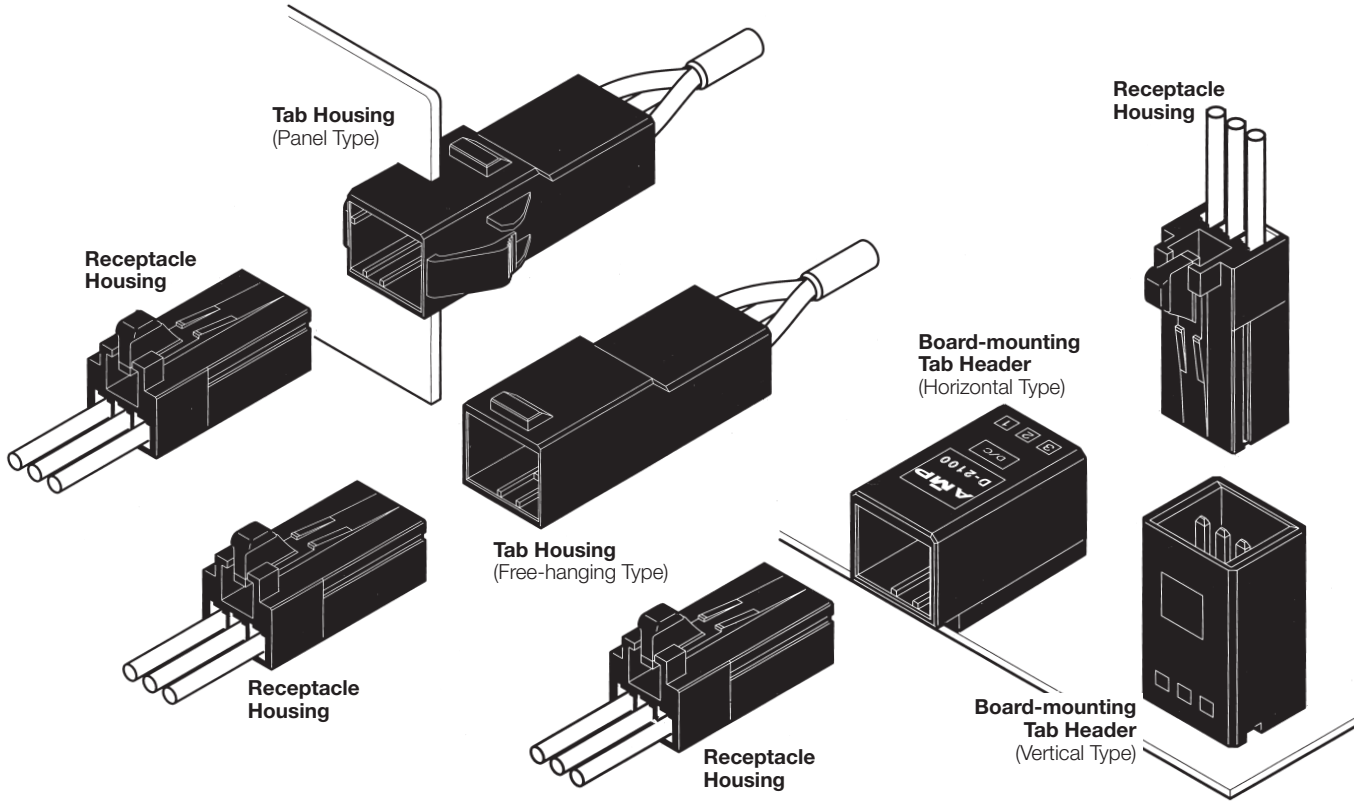

**Receptacle Housing**

**Tab Housing**

**Board-mounting Tab Header**

(Panel Type)

(Free-hanging Type)

(Horizontal Type)

(Vertical Type)

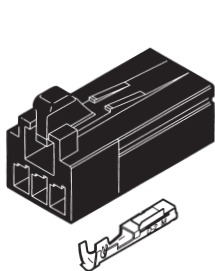

Receptacle Contact

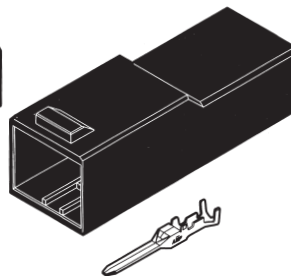
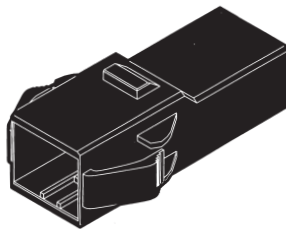

Tab Contact.....For each line of contacts, refer to the appropriate pages.

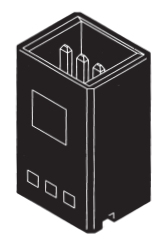
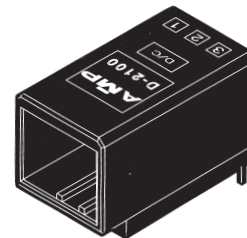

No. of Pos.	Keying	Receptacle Housing	Tab Housing		Board-mounting Tab Header	
			Panel Type	Free-hanging Type	Horizontal Type	Vertical Type
3	X	1-1318120-3	1-1318116-3	1-1318117-3	1376135-1	1318123-1
	Y	2-1318120-3	2-1318116-3	2-1318117-3	1376135-2	1318123-2
	X	1-1473074-3*	—	—	—	—

\*Drawer Type

**D-2000 Series** (Continued)

**D-2100S** (Continued)

**Keying**

Keying is provided with this product (D-2100S) for use in helping prevent misinsertion.

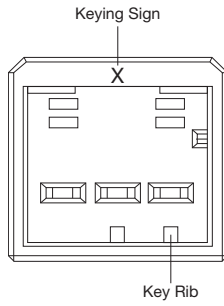

**X-Type**

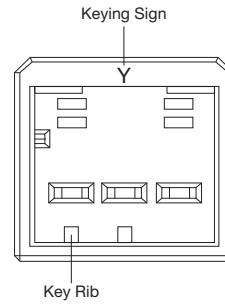

**Y-Type**

**D-2000 Series** (Continued)

**D-2100S** (Continued)

**Mating Dimensions**

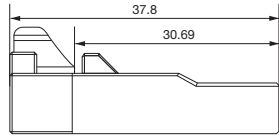

Panel / Free-hanging Type

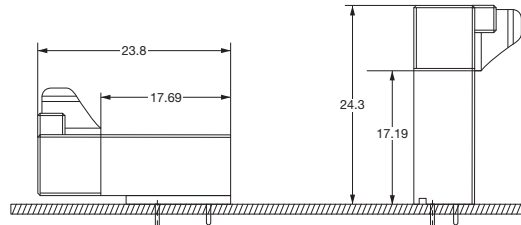

Horizontal Type

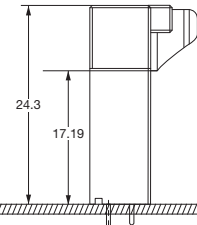

Vertical Type

**External Dimensions**

**Receptacle Housing**

Mating Tab Connector  
Part Number:

- 1318116-□
- 1318117-□
- 1318123-□
- 1376135-□

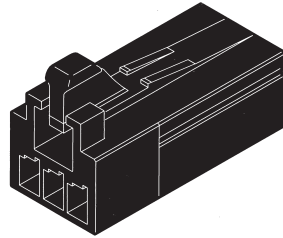

No. of Pos.	Part Number of Receptacle Housing	Dimensions	
		A	B
3	□-1318120-3	8.3	8.9
	1-1473074-3*	—	11.8

□ is for the following key codes: 1- (X-Type), 2- (Y-Type)  
\*Drawer Type

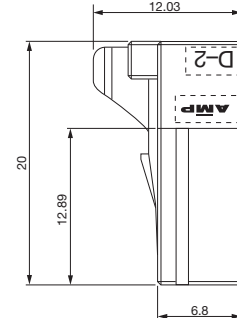
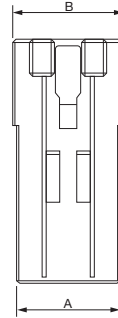
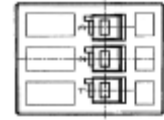
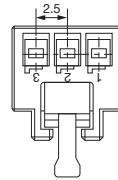

Drawer Type

**Tab Housing**

Mating Receptacle Housing  
Part Number:

- 1318120-□
- 1-1473074-3

**Panel Type**

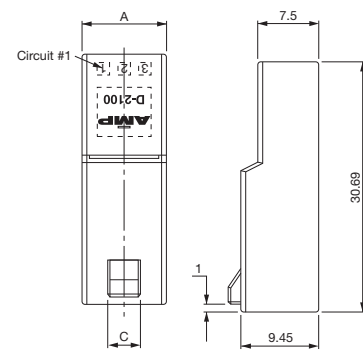
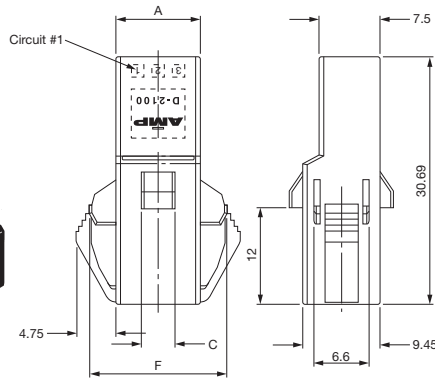
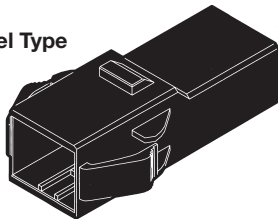

**Free-Hanging Type**

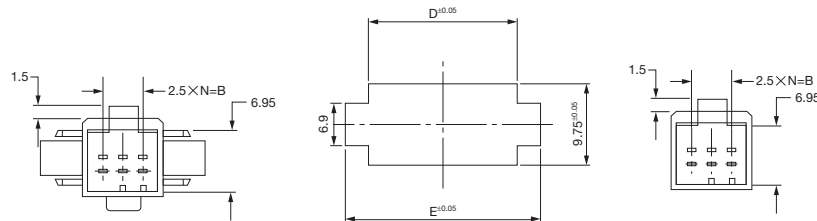
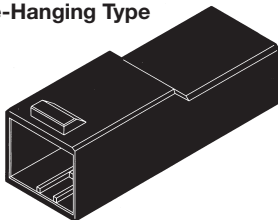

Panel Cutout

No. of Pos.	Part Number of Tab Housing		Dimensions					
	Panel Type	Free-hanging Type	A	B	C	D**	E**	F**
3	□-1318116-3	□-1318117-3	10.2	5	4	10.5	16.5	16.38

\*\*Applies only for panel type. □ is for the following key codes: 1- (X-Type), 2- (Y-Type)

**D-2000 Series** (Continued)

**D-2100S** (Continued)

**Board-mounting Tab Header  
(Vertical Type)**

Mating Receptacle Housing  
Part Number:  
□-1318120-□  
1-1473074-3

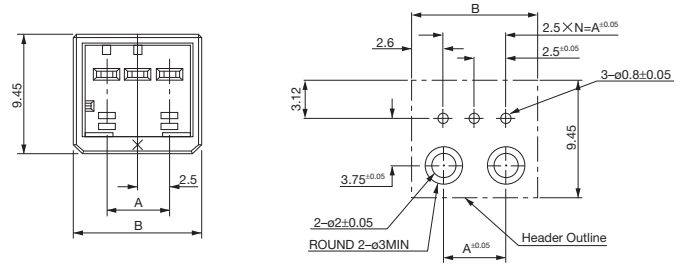
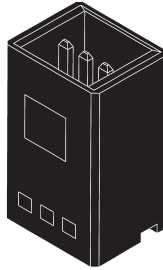

**PC Board Layout**  
Acceptable Board Thickness :  
1.6±0.3

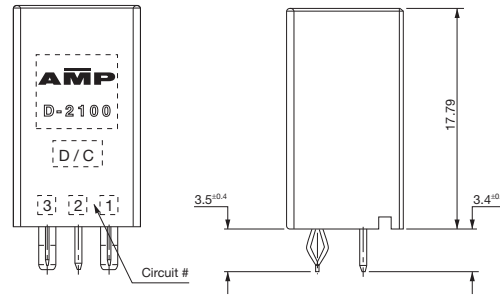

No. of Pos.	Part Number	Dimensions	
		A	B
3	1318123-□	5	10.2

□ is for the following key codes: -1 (X-Type), -2 (Y-Type)

**Board-mounting Tab Header  
(Horizontal Type)**

Mating Receptacle Housing  
Part Number:  
□-1318120-□  
1-1473074-3

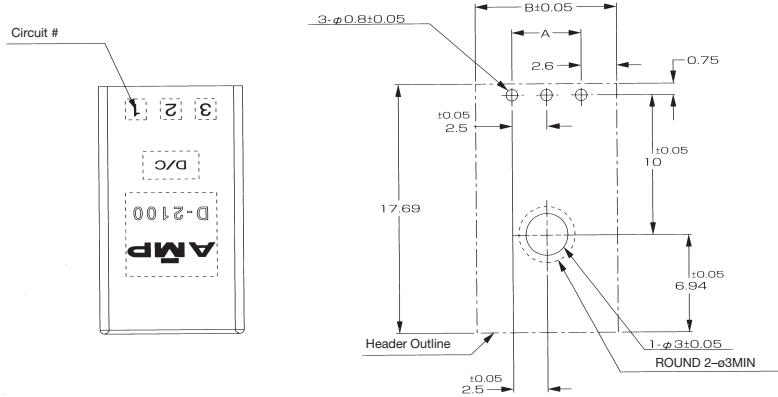
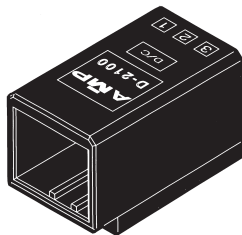

**PC Board Layout**  
Acceptable Board Thickness :  
1.6±0.3

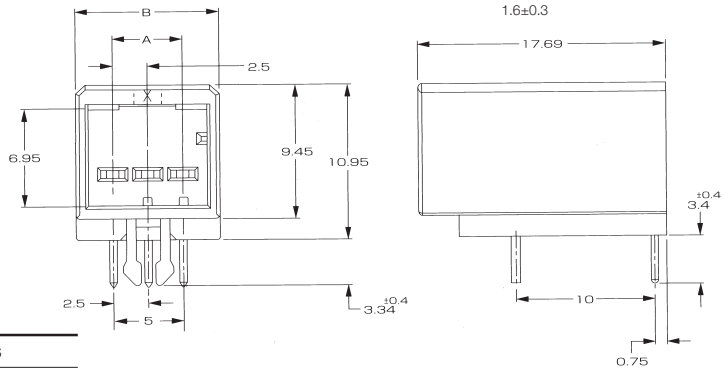

No. of Pos.	Part Number	Dimensions	
		A	B
3	1376135-□	5	10.2

□ is for the following key codes: -1 (X-Type), -2 (Y-Type)



**D-2000 Series** (Continued)

**D-2100D**

**Appearance** Board mounting pitch: 2.5mm  
 Dielectric Withstanding Voltage: 1,500V (for one minute)  
 Voltage Rating: 250 VAC

D-2000 Series

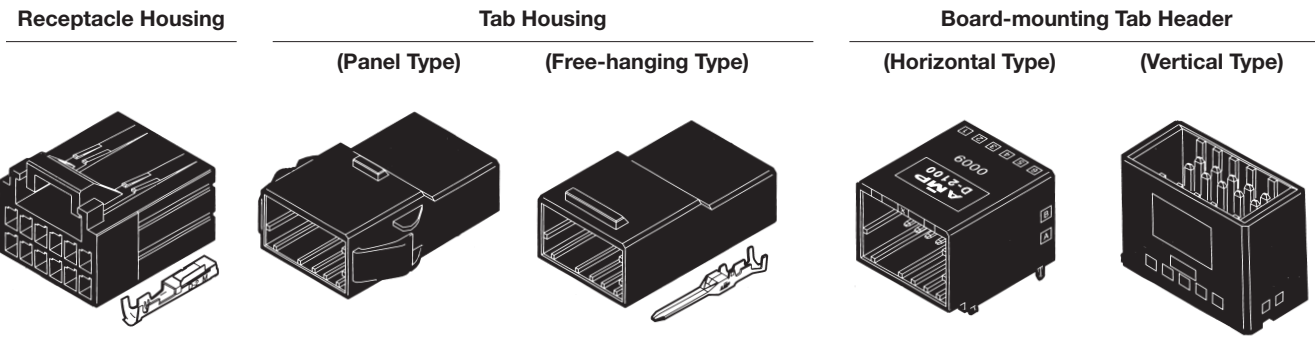
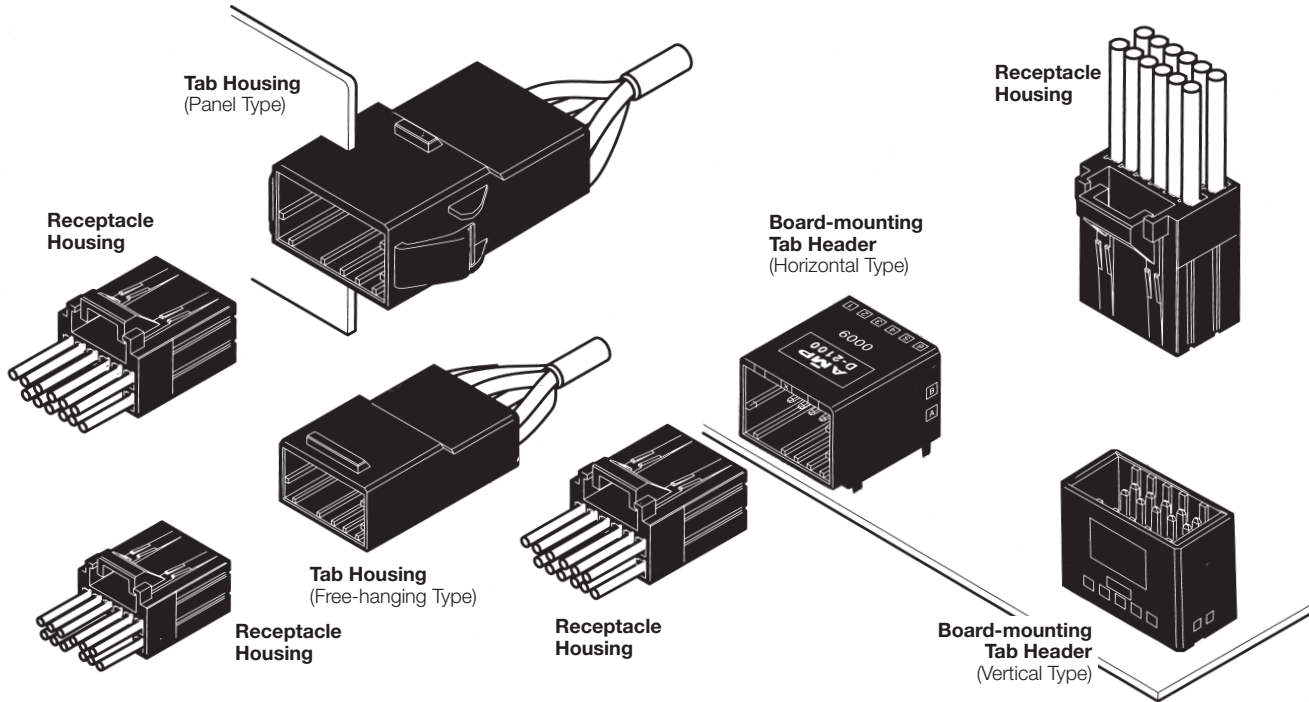

Receptacle Contact

Tab Contact.....For each line of contacts, refer to the appropriate pages.

No. of Pos.	Keying	Part Number of Receptacle Housing	Part Number of Tab Housing		Part Number of Board-mounting Tab Header	
			Panel Type	Free-hanging Type	Horizontal Type	Vertical Type
6	X	1-1318119-3	1-1318114-3	1-1318115-3	1376136-1	1318124-1
	Y	2-1318119-3	2-1318114-3	2-1318115-3	1376136-2	1318124-2
8	X	1-1318119-4	1-1318114-4	1-1318115-4	1376009-1	1318125-1
	Y	2-1318119-4	2-1318114-4	2-1318115-4	1376009-2	1318125-2
12	X	1-1318118-6	1-1318114-6	1-1318115-6	1376020-1	1318126-1
	Y	2-1318118-6	2-1318114-6	2-1318115-6	1376020-2	1318126-2
	Z	3-1318118-6	—	—	—	1318126-3
16	X	1-1318118-8	—	—	—	1747994-1
	Y	2-1318118-8	—	—	—	1747994-2
20	X	1-1318118-9	1-1318114-9	1-1318115-9	1376137-1	1318127-1
	Y	2-1318118-9	2-1318114-9	2-1318115-9	1376137-2	1318127-2

**D-2000 Series** (Continued)

**D-2100D** (Continued)

**Keying**

Keying is provided with this product (D-2100D) for use in helping prevent misinsertion.

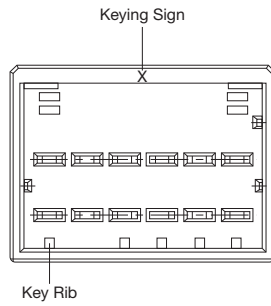

**X-Type**

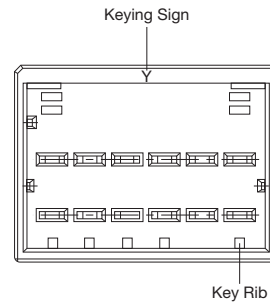

**Y-Type**

**D-2000 Series (Continued)**

**D-2100D (Continued)**

**Mating Dimensions**

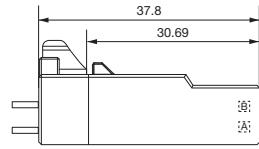

Panel / Free-hanging Type

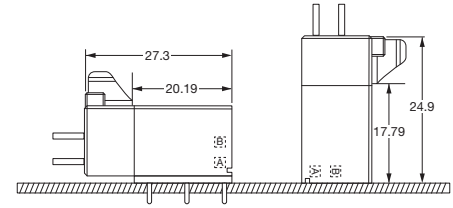

Horizontal Type

Vertical Type

**External Dimensions**

**Receptacle Housing**

**Mating Tab Connector**

**Part Number:**

- 1318114-□ □-1376136-□
- 1318115-□ □-1376009-□
- 1318124-□ □-1376020-□
- 1318125-□ □-1376137-□
- 1318126-□ □-1747994-□
- 1318127-□

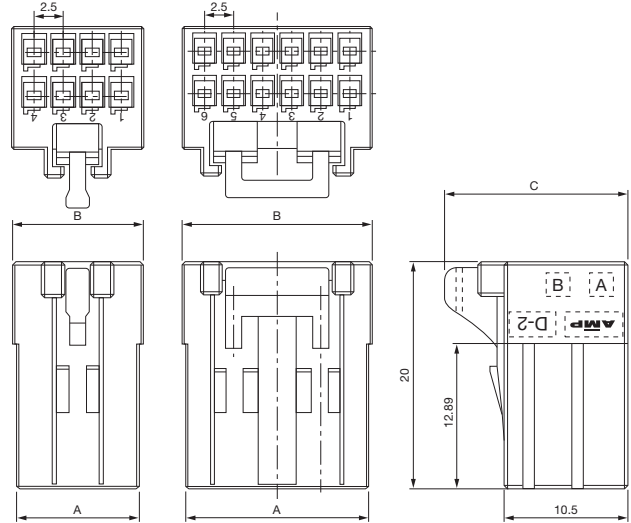
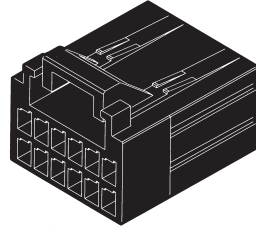

No. of Pos.	Part Number of Receptacle Housing	Dimensions		
		A	B	C
6	□-1318119-3	8.3	8.9	15.8
8	□-1318119-4	10.8	11.4	15.8
12	□-1318118-6	15.8	16.4	14.8
16	□-1318118-8	20.8	21.4	14.8
20	□-1318118-9	25.8	26.4	14.8

□ is for the following key codes:  
1- (X-Type), 2- (Y-Type), 3- (Z-Type - Only 12 position)

**Tab Housing**

**Mating Receptacle Housing**

**Part Number:**

- 1318119-□ □-1318118-□

**Panel Type**

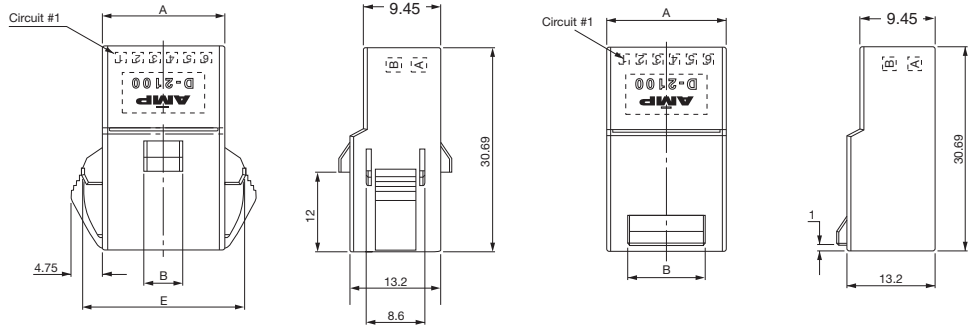
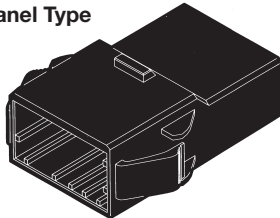

**Free-Hanging Type**

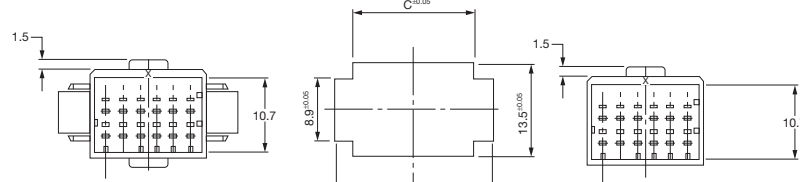
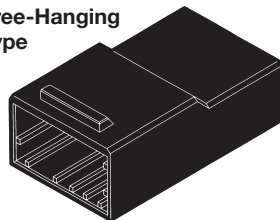

Panel Cutout

No. of Pos.	Part Number of Tab Housing		Dimensions				
	Panel Type	Free-hanging Type	A	B	C**	D**	E**
6	□-1318114-3	□-1318115-3	10.2	4	10.5	16.5	16.38
8	□-1318114-4	□-1318115-4	12.7	4	13	19.0	18.88
12	□-1318114-6	□-1318115-6	17.7	11.5*	18	24.0	23.88
20	□-1318114-9	□-1318115-9	27.7	11.5*	28	34.0	33.88

\*\*Applies only for panel type. \*The dimension "B" for panel type is 6.0mm.

□ is for the following key codes: 1- (X-Type), 2- (Y-Type)

**D-2000 Series** (Continued)

**D-2100D** (Continued)

**Board-mounting Tab Header (Vertical Type)**

**Mating Receptacle Housing**

**Part Number:**

□-1318119-□

□-1318118-□

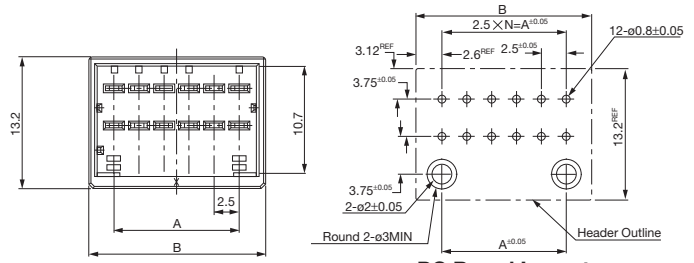
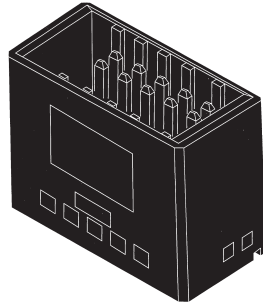

**PC Board Layout**  
Acceptable Board Thickness : 1.6±0.3

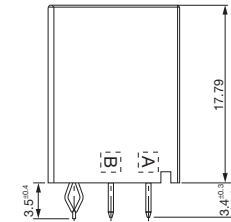
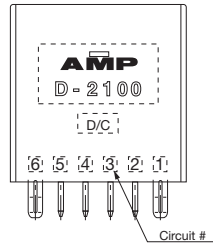

No. of Pos.	Part Number	Dimensions	
		A	B
6	1318124-□	5	10.2
8	1318125-□	7.5	12.7
12	1318126-□	12.5	17.7
16	1747994-□	17.5	22.7
20	1318127-□	22.5	27.7

□ is for the following key codes:  
-1 (X-type), -2 (Y-Type)

**Board-mounting Tab Header (Horizontal Type)**

**Mating Receptacle Housing**

**Part Number:**

□-1318119-□

□-1318118-□

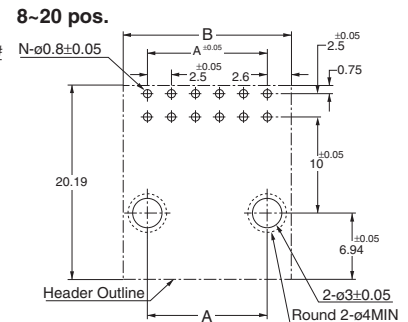
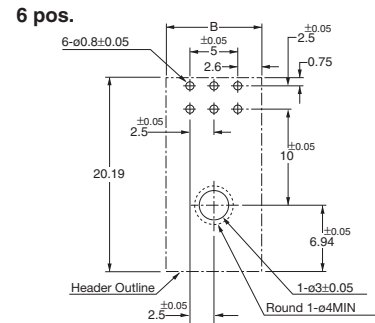
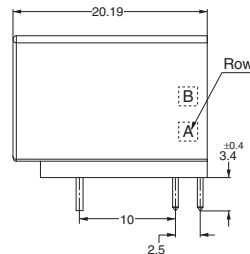
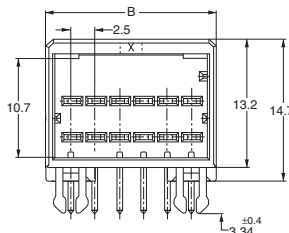
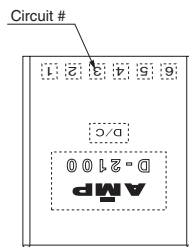
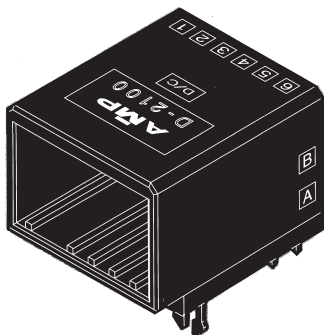

**PC Board Layout**  
Acceptable Board Thickness : 1.6±0.3

No. of Pos.	Part Number	Dimensions	
		A	B
6	1376136-□	—	10.2
8	1376009-□	7.5	12.7
12	1376020-□	12.5	17.7
20	1376137-□	22.5	27.7

□ is for the following key codes:  
-1 (X-type), -2 (Y-Type)

**D-2000 Series** (Continued)

**D-2100M Drawer Type**

**Appearance**

Board mounting pitch : 2.5mm  
Dielectric Withstanding Voltage : 2.3kV (wire-to-wire type), 1.5kV (wire-to-board type)  
Current rating : 2.6A (with 20 AWG, 50 pos.)

**Application 1**

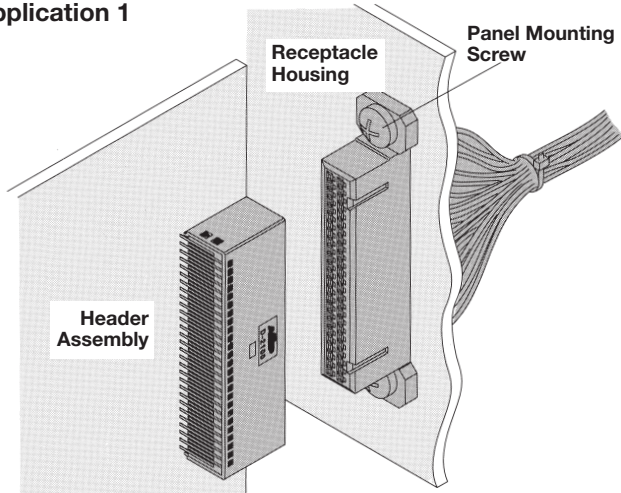

Suitable for an application where the receptacle side is drawer-able and the tab side is fixed.

\*The receptacle housing is fixed on the panel with fixed screws.

	Part Number
Receptacle Housing (50 Pos.)	1318577-1
Panel Mounting Screw	900167-1
Header Assembly (50 Pos.)	1318579-1

**Application 2**

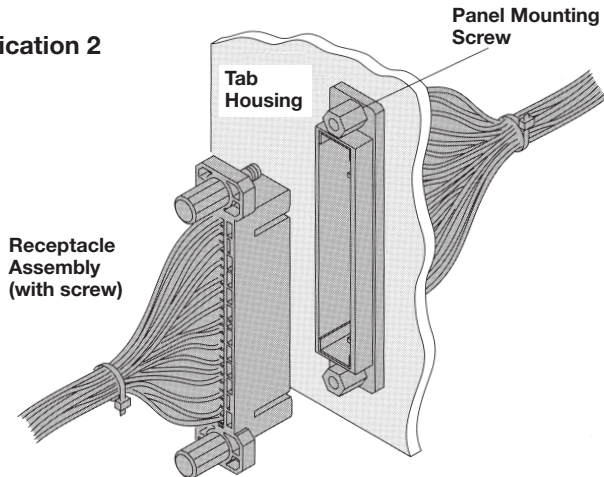

The tab housing is fixed on the panel. The receptacle assembly is mated by turnable jackscrews. Can be used as a wire-to-wire connector with a panel or a bulkhead.

	Part Number
Receptacle Assembly (with screw) (50 Pos.)	1376072-2
Panel Mounting Screw	1376059-1
Tab Housing (50 Pos.)	1318578-2

**Application 3**

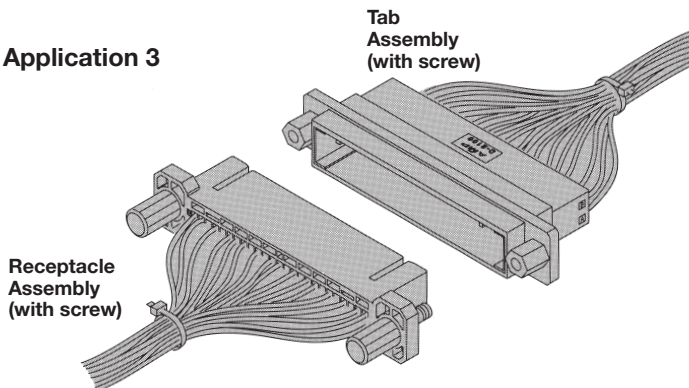

Can be used as a wire-to-wire connector. The tab and receptacle assemblies are mated with two jackscrews on both sides.

	Part Number
Receptacle Assembly (with screw) (50 Pos.)	1376072-2
Tab Assembly (with screw) (50 Pos.)	1376073-2

D-2000 Series

**Product Specification:** 108-5659

**D-2000 Series** (Continued)

**D-2100M Drawer Type**  
(Continued)

**Mating Dimensions**

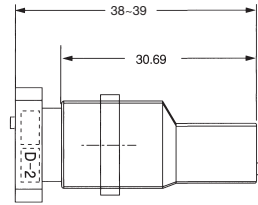

Panel/Free-Hanging Type

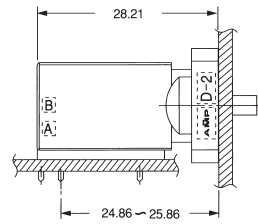

Drawer Type

**External Dimensions**

**Receptacle Housing**

Mating Header Assembly  
Part Number:  
1318579-1

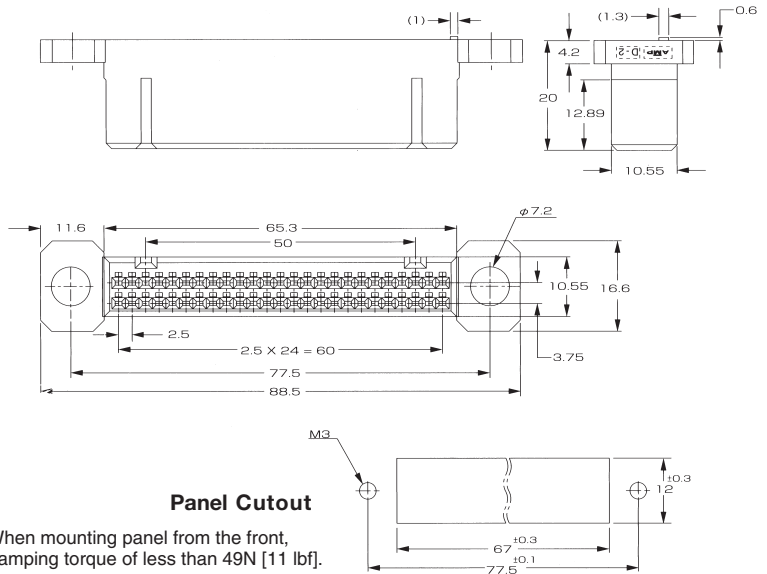
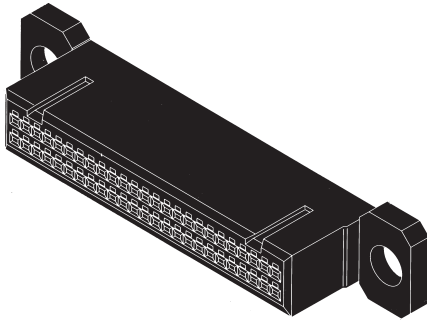

Panel Cutout

Note: When mounting panel from the front, apply clamping torque of less than 49N [11 lbf].

No. of Pos.	Part Number
50	1318577-1

**Tab Housing**

Mating Receptacle Assembly  
Part Number:  
1376072-2

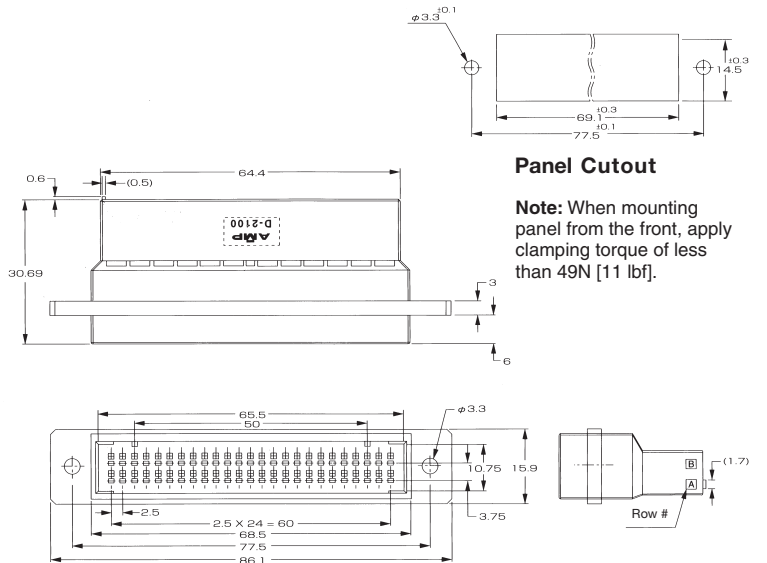
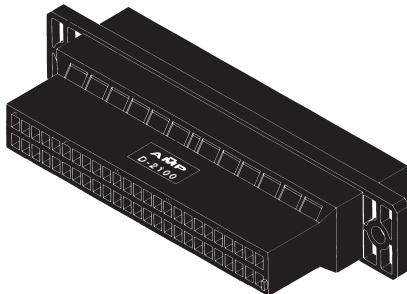

Panel Cutout

Note: When mounting panel from the front, apply clamping torque of less than 49N [11 lbf].

No. of Pos.	Part Number
50	1318578-2



**D-2000 Series** (Continued)

**D-2100M Drawer Type**

(Continued)

**Board-Mount Tab Header  
(Horizontal Type)**

**Mating Receptacle Housing**

**Part Number:**

**1318557-1**

D-2000 Series

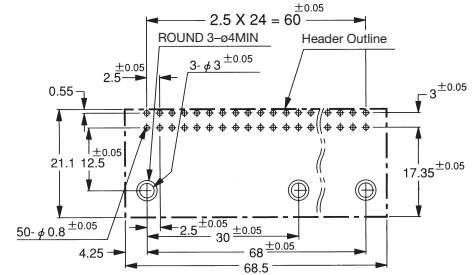
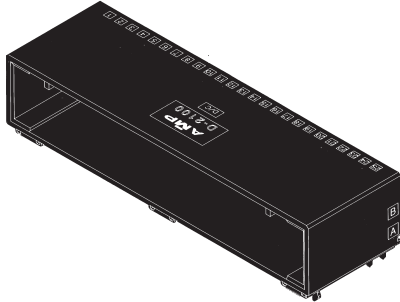

**PC Board Layout**

Applicable Board Thickness :  
1.6±0.4

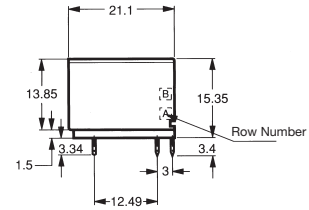
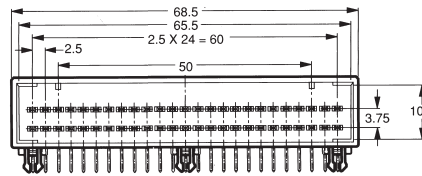

No. of Pos.	Part Number
50	1318579-1

**Panel Mounting Screw**

Part Number
900167-1

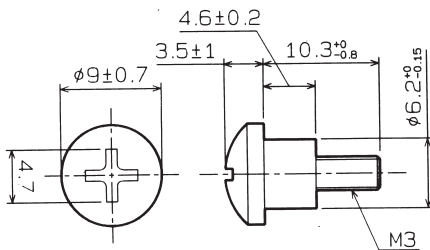
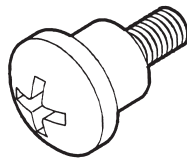

**Panel Mounting Screw**

Part Number
1376059-1

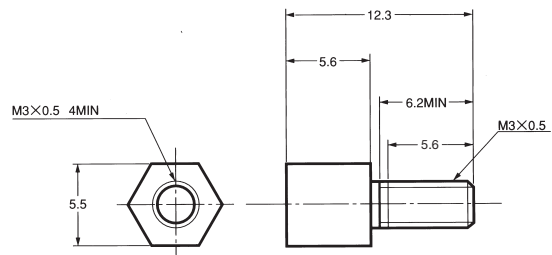
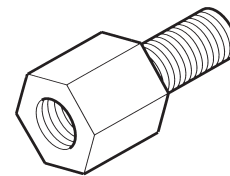

**D-2000 Series** (Continued)

**D-2100M Screw Lock Type**

**Receptacle Assembly  
(with screw)**

**Mating Tab Assembly**  
**Part Number:**  
1318578-2  
1376073-2

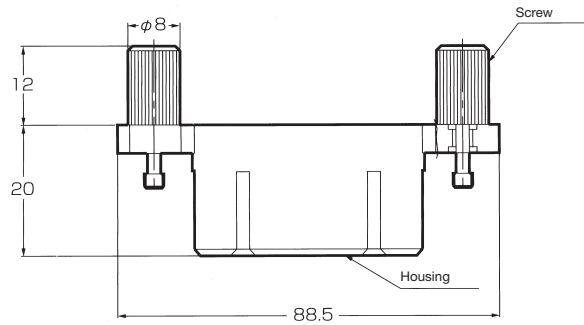
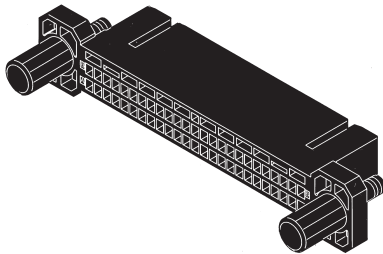

No. of Pos.	Part Number
50	1376072-2

**Tab Assembly  
(with screw)**

**Mating Receptacle Assembly**  
**Part Number:**  
1376072-2

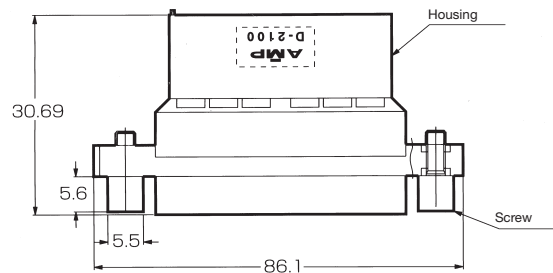
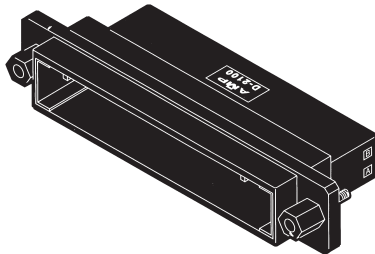

No. of Pos.	Part Number
50	1376073-2

**D-2000 Series** (Continued)

**D-2600 Series**



**D-2600 Series Connectors combine power and signal lines, which can dramatically improve productivity by reducing assembly steps.**

Power lines (15A\*/contact) and signal lines (5A\*/contact) with different size contacts are combined in the Dynamic 2600 Series. Along

with being able to mate different size wires at one time, it contributes to more compact sizes and fewer assembly steps, and it also makes maintenance more efficient. On top of that, the contact has complete compatibility with the Dynamic D-2000 and D-3000 Series so new components and

applicators are not needed, eliminating the need for new equipment costs. Low mating force and mating/unmating and contact reliability continue to be superior to provide easy handling.

\*The current ratings noted above are for 1 contact. The current rating is derated depending on the number of contacts.

**Performance Characteristics**

**Pitch** — D-2: 2.5 mm / -3: 3.81 mm

**Voltage Rating** — 250 VAC

**Current Rating** — D-2: 3.2 A;  
D-3: 7.5 A

**Contact Resistance** — 10 mΩ Max.

**Dielectric Withstanding Voltage** —  
1500 V 1 minute

**Operating Temperature** —  
-55°C to +105°C

\*When connectors are used singly.

**Material and Finish**

**Receptacle Contact** — Copper alloy, gold plated over 1.27 μm nickel underplate

**PCB Tab Post** — Copper alloy, 0.38 μm gold plated over 1.27 μm nickel underplate, Tab post tin plated

**Housing** — Glass Filled Polyester (PBT), UL 94V-0

**Technical Documents**

**Product Specification**  
108-78301

**Application Specification**  
114-5258  
114-5148

**D-2 Contact (Refer to page 19)**

**D-3 Contact (Refer to page 38)**

**D-2000 Series** (Continued)

**D-2600 Series** (Continued)

**Mating Dimensions**

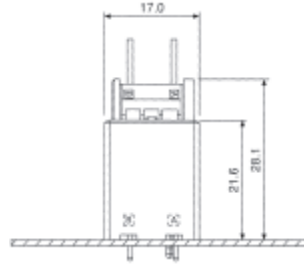

Vertical Type

**Dimensions**

**Receptacle Housing**

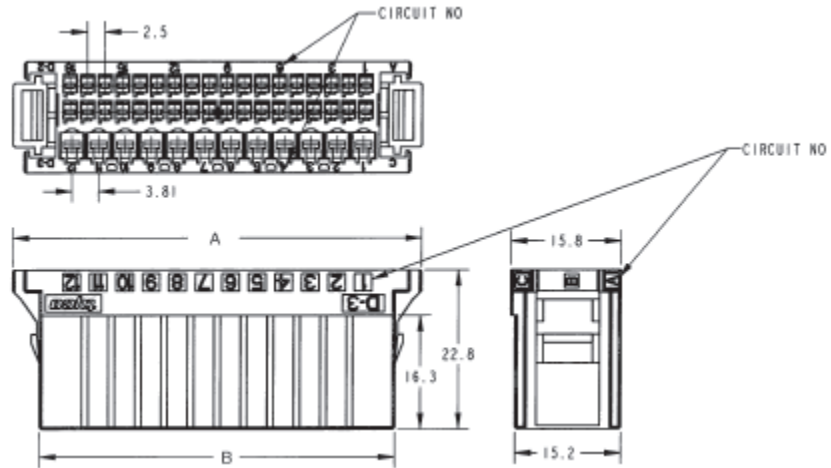

No. of Pos.	Part Number	Dimensions	
		A	B
48	1827540-1	58.65	51.0

**Board Mount Tab Header (Vertical Type)**

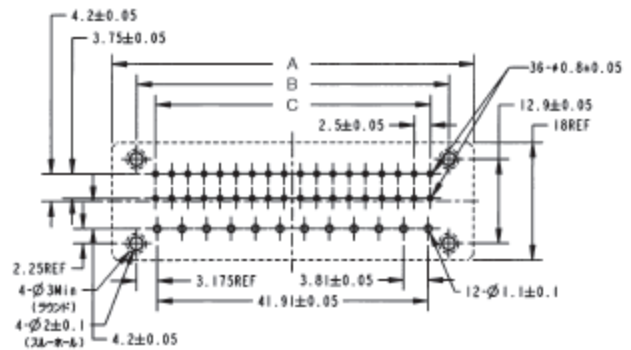
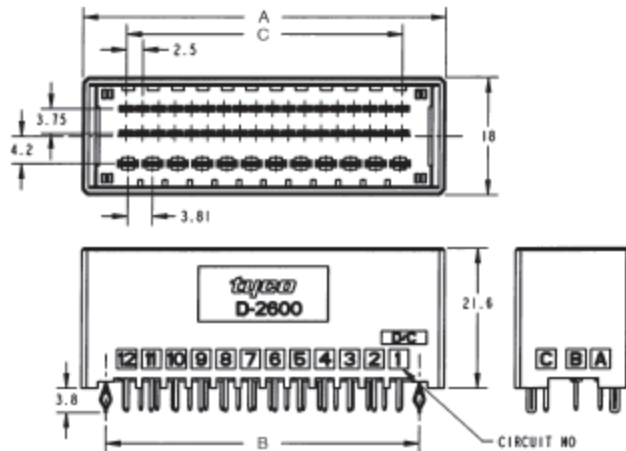

**PC Board Layout**

Acceptable Board Thickness : 1.0-1.6±0.1

No. of Pos.	Part Number	Dimensions		
		A	B	C
48	1827538-1	55.91	48.26	42.50