

# **ADuC7XXX MicroConverter™ Get Started Guide**

**A tutorial guide for use with the ADuC7XXX QuickStart™ and ADuC7XXX QuickStart Plus Development Systems**

**The following products are covered by this guide**

**ADuC7020/21/22/24/25/26/27/28/29**

**ADuC7023**

**ADuC7034/6/9**

**ADuC7060/61**

**ADuC7121/22**

**ADuC7124/26**

**ADuC7128/29**

***Version 0.4***

**CONTENTS:**

<b>Introduction</b>	<b>pg 3</b>
<b>(1) Installation</b>	<b>pg 4</b>
<b>(2) Keil <math>\mu</math>Vision3 Integrated Development Environment</b>	<b>pg 7</b>
<b>(3) IAR Embedded Workbench IDE and ROM Monitor</b>	<b>pg 20</b>
<b>(4) The Windows I2C Downloader</b>	<b>pg 23</b>
<b>(5) Elves</b>	<b>pg 24</b>
<b>(6) PLA Tool</b>	<b>pg 26</b>
<b>(7) The Windows Serial Downloader</b>	<b>pg 28</b>
<b>(8) Windows Analog Software Program (WASP)</b>	<b>pg 31</b>
<b>(9) LIN Windows Serial Downloader</b>	<b>pg 34</b>
<b>(10) Installed Documentation and Code Directory</b>	<b>pg 35</b>

**Technical Support:**

North America and ROW: [linear.apps@analog.com](mailto:linear.apps@analog.com)  
Europe: [euro.linear@analog.com](mailto:euro.linear@analog.com)  
China: [china.support@analog.com](mailto:china.support@analog.com)

## INTRODUCTION

The following Get Started tutorial guide will bring the user through the various tools that are part of the MicroConverter development systems. This application will install tools required for the ADuC702X, ADuC706X, ADuC7034/6/9 and ADuC712x, ADuC7124/26 generics.

The tools discussed during this Get Started tutorial guide are as follows:

Tool	Executable	Function
<b>Keil µVision3 Integrated Development Environment</b>	MDK380a.exe	<p>µVision3 is a complete IDE (Integrated Development Environment) integrating all the tools necessary to edit, assemble/compile/link and debug ARM/Thumb code and C code, via the JTAG port.</p> <p>A simulator is also available, simulating the peripherals of the ADuC7XXX parts.</p> <p>Non-intrusive emulation is done through JTAG using the mIDAS-Link provided in the QuickStart Plus development system.</p>
<b>IAR Embedded Workbench IDE</b>	EWARM-KS- WEB- 5407.exe.exe	<p>The IAR Embedded Workbench IDE provided in a zip file in the folder, C:\ADuC7xxxV0.2\Applications\IAR is a complete IDE (Integrated Development Environment) integrating all the tools necessary to edit, assemble/compile/link and debug ARM/Thumb code and C code, via the JTAG port .</p> <p>Non-intrusive emulation is done through JTAG using the mIDAS-Link provided in the QuickStart Plus development system.</p> <p>Debugging via UART is done using a ROM monitor included on the CD.</p>
<b>Downloader</b>	I2CWSD.exe	<p>The I2C Downloader is a windows software program that allows a user to download Extended Intel Hex files as created by µVision3 to the MicroConverter via the I2C bus while in circuit.</p> <p>The package also contains a specific version of the I2C Downloader specifically for the ADuC7023 evaluation boards. This Special I2CWSD version does not require an external dongle – it can interface directly with the ADuC7023 evaluation board via the USB interface.</p>
<b>PLA tool</b>	PLAtool.exe	<p>The PLA tool is a graphical tool allowing the user to easily choose the input/output and function of the elements and generating C or assembly code.</p>
<b>Downloader</b>	ARMWSD.exe	<p>The Serial Downloader is a windows software program that allows a user to serially download Extended Intel Hex files as created by µVision3 to the MicroConverter while in circuit.</p>
<b>Analysis</b>	WASP7.exe	<p>The Windows Analog Software Program (WASP) is a windows software program for all ADuC702x MicroConverter products that allows analysis of their analog performance.</p>
<b>Software Generation</b>	Elves.exe	<p>Elves.exe is an application that assists a C programmer in choosing appropriate functions from ADI libraries and simplifies deciding what values to place in the function parameters.</p>

## (1) INSTALLATION

**Installing from CD or FTP site:** (<ftp://ftp.analog.com/pub/MicroConverter/ADuC7XXXV0.2/>)

- 
- Close all your applications.
- Insert the MicroConverter® Development System CD ROM into you CD ROM drive and double-click on the file "ADuC7xxxV02.exe" if installation doesn't start automatically.
- Follow the installation process to the final menu. The following applications will be installed
  - Multidongle Application
  - Segger J-LINK Application
  - Microsoft .Net Framework (Application is likely already installed on user machine so installation is optional)
  - PLA Tools
  - Various WSD Applications
- Press "yes" to the above applications. Then follow the on-screen instructions to install the software on your PC.
- Although you can install the MicroConverter® Development System, the IAR Embedded workbench and Keil software onto any hard drive and into any directory you wish, for the purposes of simplicity, the rest of this document will assume that you've installed at the default location of C:\ADuC7XXXV0.2, C:\Program Files and C:\keil. Also the Keil tools will automatically be installed under an ARM directory and are fully compatible with uVision3 or tools for 8051.

### **Tools installation options:**

During the installing documents, code examples and utilities provided by ADI, the option to install Microsoft .NET Framework version 2.0 on the user PC will appear. In the event that .NET Framework is not previously installed ( To check if the .NET Framework is installed, go to Windows start menu, Control Panel, "Add or Remove Programs" in the control panel and see if "Microsoft .NET Framework" is installed, if .NET Framework is previously installed and an attempt is made to re-install this software, the installer for the .NET Framework will fail), this application should be installed if not previously done so, as it is required for the installation of the ADI PLA tools. In addition, the installation will offer you the option to select the Keil uVision3 tools to be installed automatically by this setup. In addition using the separate IAR Embedded Workbench CD or using the IAR installer located at C:\ADuC7XXXV0.2\Applications\IAR, the IAR tools may be installed.

### **Keil uVision3 installation:**

- The Keil  $\mu$ Vision3 Installation is initiated by ticking the "Yes, I want to install Keil uVision3 tools" as shown below:

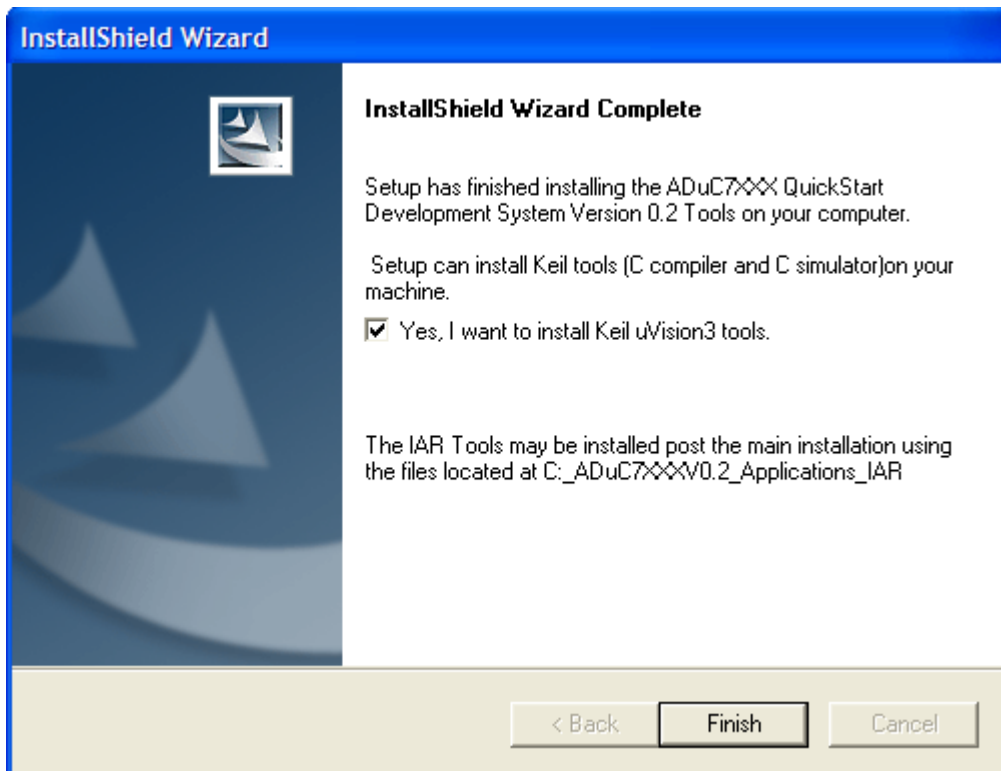

A message will appear to confirm that the installs have been selected:



- Press “Next” and follow the on screen instruction.
- If you choose not to install the tools now, you can install them later by double clicking on the file “MDK380a.EXE” in the Applications\Keil folder on the CD.

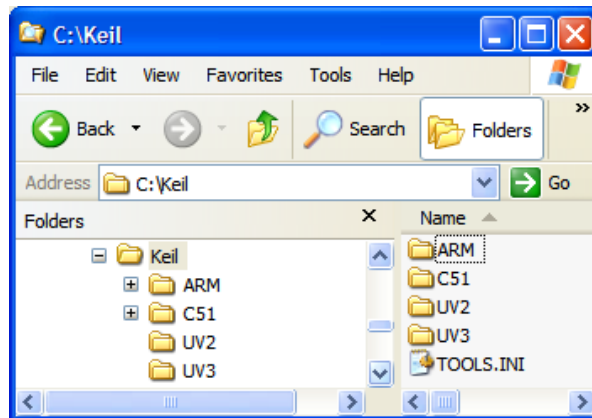

- When plugging the MIDAS-Link emulator for the first time, the following window appears:



Select “Install from a list or specific location” and press next. Then select “Include this location in the search” and enter the path of the USB driver: C:\ADuC7XXXV0.2\Applications\usbdriver. Press next.

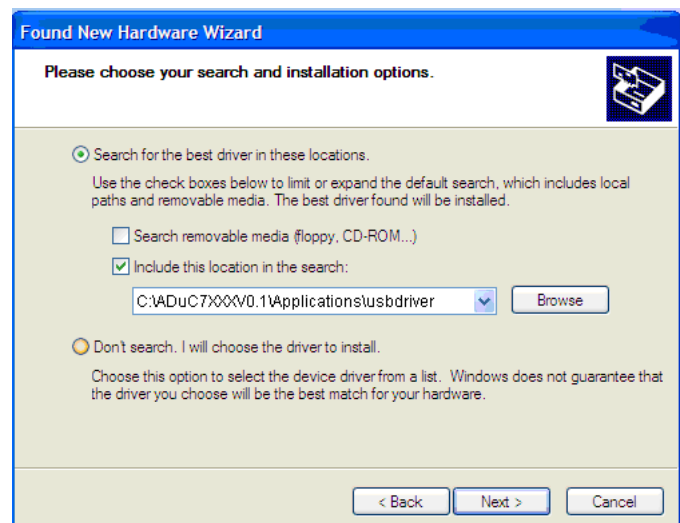

In the hardware installation window, select Continue anyway.



Finally when the following window appears press the Finish button.

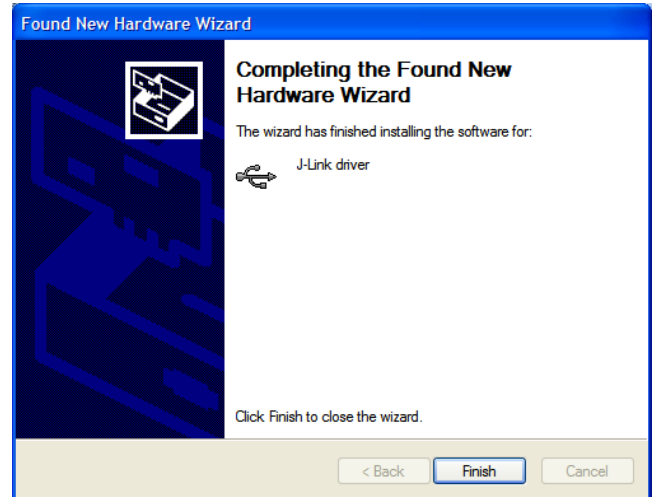

When launching the I2CWSO application for the first time it may be required to point to the directory where the applications USB drivers are installed. If prompted please enter the following location C:\Program Files\Analog Devices Inc\MultiDongle\Driver.

#### IAR Embedded Workbench installation:

- The IAR Embedded Workbench is available as part of the ADuC7XXX package, however it is not automatically launched as part of the installation procedure. If you choose not to install the IAR Embedded Workbench now, you can install it later by double clicking on the file "EWARM-KS-WEB-5407.exe" at C:\ADuC7XXXV0.2\Applications\IAR. Then the file C:\ADuC7XXXV0.2\Applications\IAR\copy.bat needs to be run after IAR has been installed in order to include the most up to date ADI products.
- To install, follow the on screen instructions. IAR Embedded Workbench will require registering on IAR website to obtain a license key. At this point the latest edition of the IAR tools can be downloaded instead of the version of the tools included on this CD.

## (2) KEIL $\mu$ VISION3 INTEGRATED DEVELOPMENT ENVIRONMENT

The  $\mu$ Vision3 IDE integrates all the tools necessary to edit, assemble and debug code. The ADuC7XXX Development System supports non-intrusive emulation limited to 32kByte code. This section describes the project setup steps in order to download and debug code on an ADuC7XXX evaluation system. The ADuC7023 is used as the primary example in this section. ADI recommends using the J-Link debugger driver as described in the following section however the RDI debugger driver described below may also be used.

### 2.1 Starting $\mu$ Vision3

1. From the START menu choose All Programs  $\rightarrow$  Keil  $\mu$ Vision3. This loads the  $\mu$ Vision3 IDE. The  $\mu$ Vision3 executable is located at C:\Keil\UV3\Uv3.exe.

### 2.2 Toolbars

2. Under the VIEW menu, four toolbars are available:
  - a. Status Bar
  - b. File Toolbar
  - c. Build Toolbar
  - d. Debug Toolbar

The Build Toolbar will be active only when the IDE is in Edit/Compile mode. The Debug toolbar will be active only in Download/Debug mode.

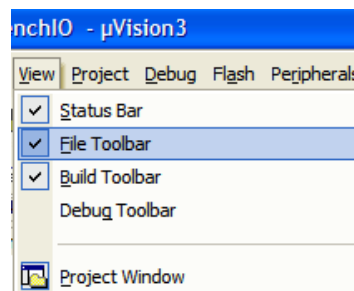

### 2.3 Starting a project

3. From the project menu select New Project as shown below.

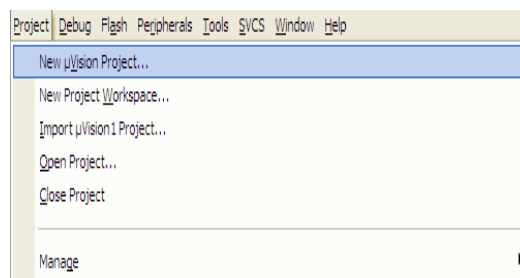

4. Create a new folder ADIdemo under C:\Keil\ARM\ Examples and enter the name of the project as Demo. You will then be asked to select the device. Select the part number corresponding to your evaluation board under Analog Devices.

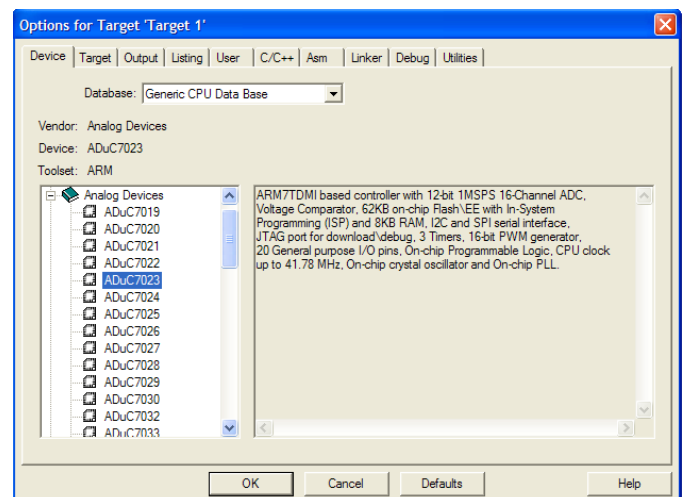
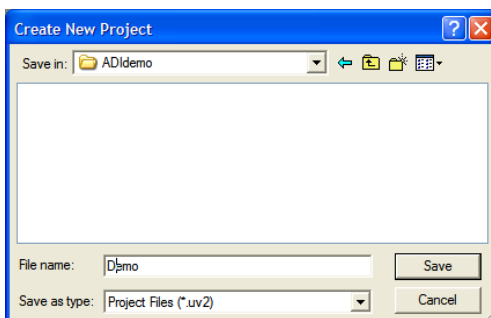

The following message appears. Select "No" not to include automatically the startup file startup.s to your project.

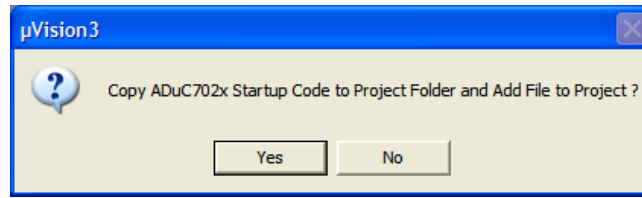

It is possible to change compiler by selecting  “setup file extensions, books and environment”, “folder extension”.

a. For this demo, select the RealView Compiler:

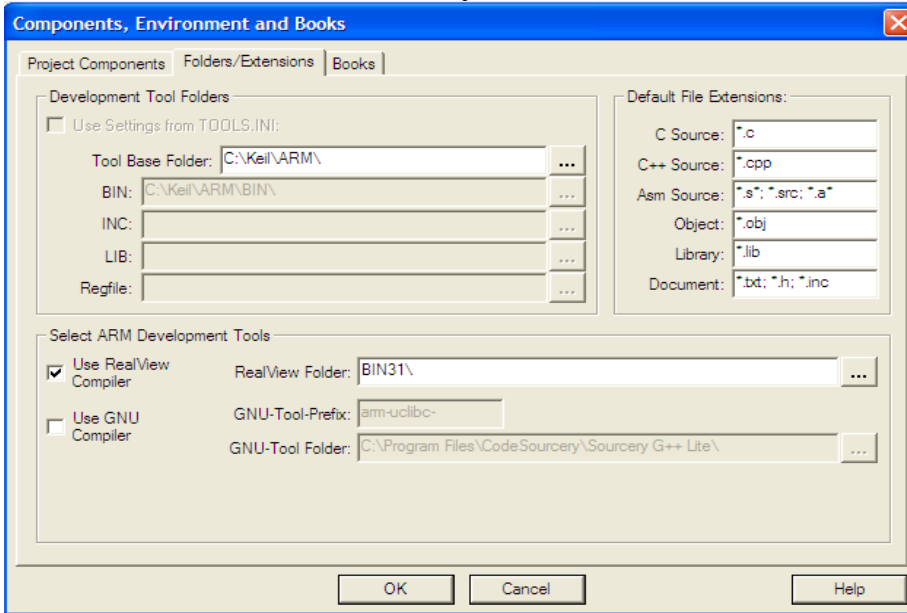

5. Right click on Target1 and select “Option for Target1” to configure the settings of this project. By default, uVision3 will use the RealView compiler.

Add “0x80000” into the R/O Base and “0x10000” in to the R/W Base to indicate to the Compiler the Flash and RAM start addresses. Check the button “Use Memory Layout from Target Dialog”.

a.

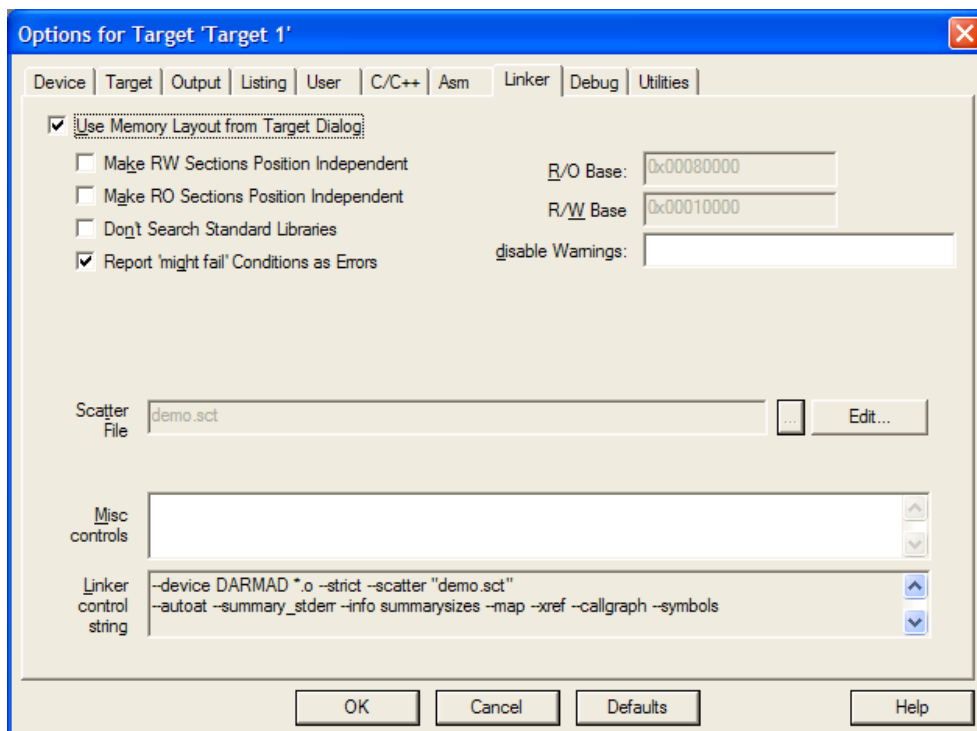

b. In the “Output” panel select “Create HEX File”. The HEX file can be used by the I2C downloader.



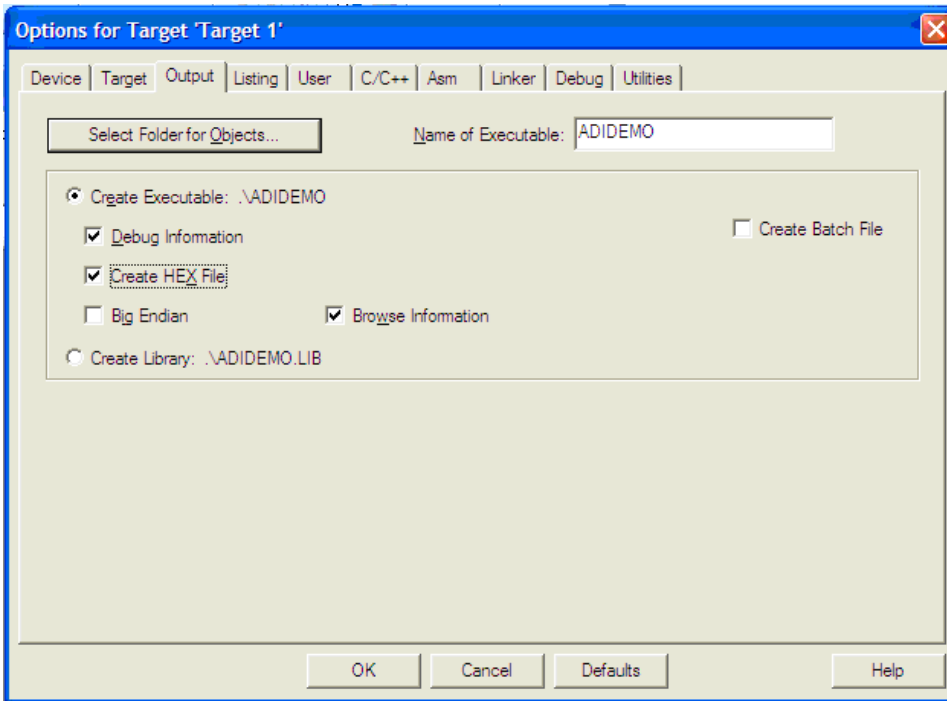

- c. In the “Target” panel, ensure the IROM1 and IRAM1 Start and Size tabs are filled in correctly.

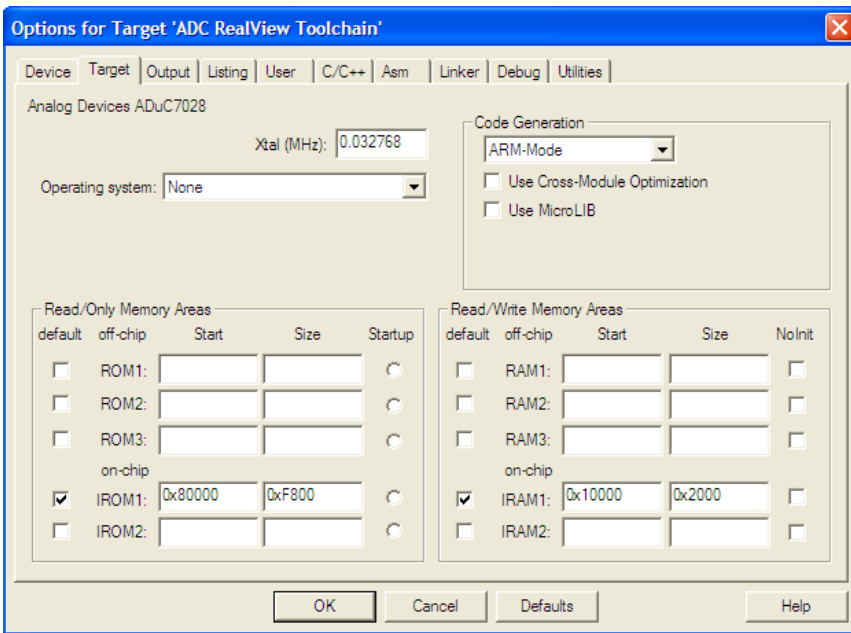

- d. If you have an emulator, power up the evaluation board using a 9V power supply or, via the USB connection. Connect the evaluation board to the mIDAS-Link and the mIDAS-Link to your PC’s USB port using the provided USB cable.  
**Note:** a green LED on the mIDAS-Link emulator blink a few times before staying on, indicating that the emulator is communicating correctly with the PC.

## 2.4 Configuring the J-Link Debugger driver

- a. If you are using an evaluation board and want to use the RDI driver, then continue to section 2.4.1.

Right click on Target1 and select “Option for Target1” to configure the settings of this project. By default,  $\mu$ Vision3 will use the RealView. In the “Debug” panel, select Use ... and choose J-LINK / J-TRACE if you have a mIDAS-Link emulator. Select the settings button and configure as follows.

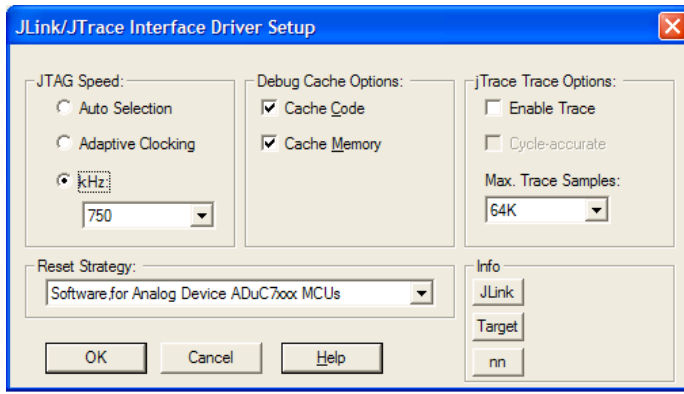

If your development system doesn't include a JTAG emulator, use the simulator for this exercise.

- b. In the "Utilities" panel, select "Use Target Driver for Flash Programming", chose "J-LINK / J-TRACE" and tick the option "Update Target before Debugging".

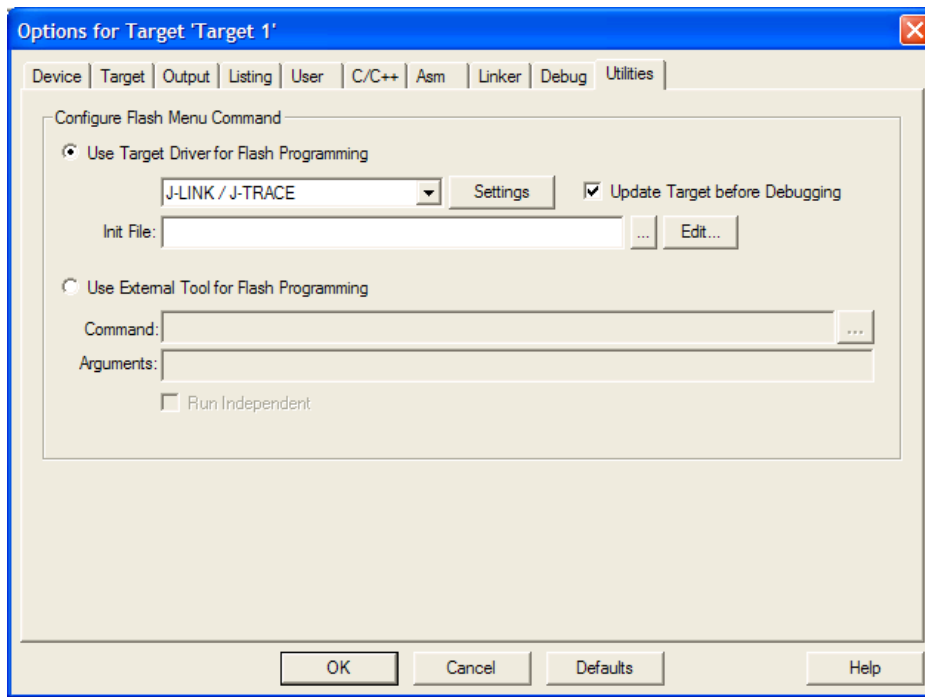

Hit the "Settings" option and the following dialog box will appear –

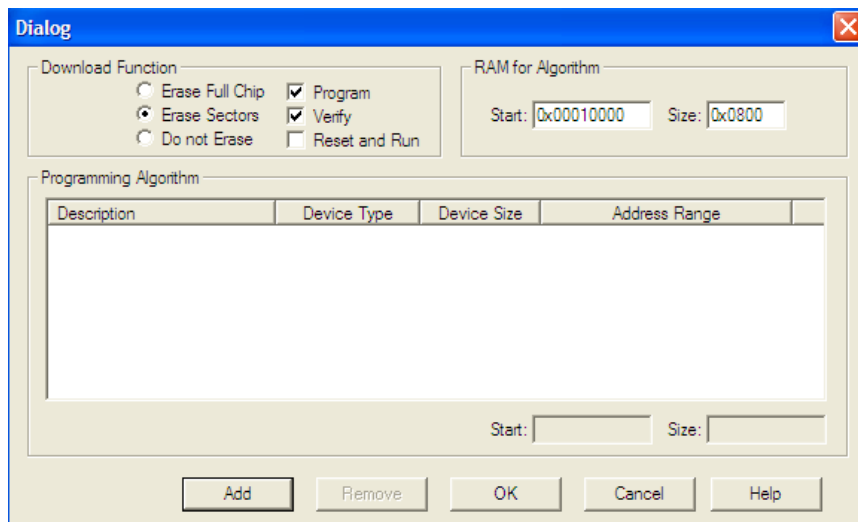

Select “Add” for the next window. Select the driver for the generic that you are evaluating. For this example use “ADuC702X Flash (v1.1)” and press “Add”

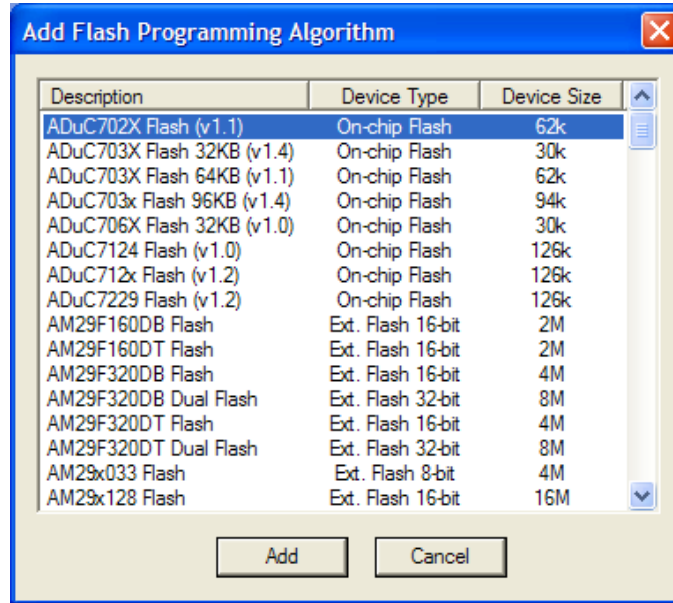

Then the following window will appear – Press “ok” at this point.

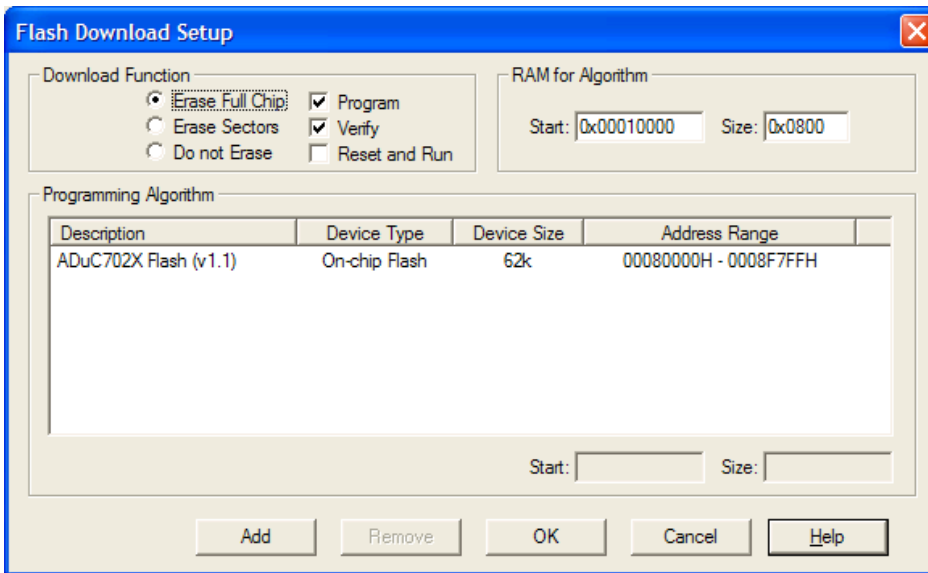

- c. Press OK again, all the options should be properly configured to compile, assemble, link, download and debug using mIDAS-Link or the simulator.

#### 2.4.1 Configuring the RDI Debugger driver on the ADuC7023

In the “Debug” panel, select Use ... and choose RDI Interface Driver if you have a mIDAS-Link emulator. Select the settings button and give the path to the JLinkRDI.dll - C:\Program Files\SEGGER\JLinkARM\_V4081\JLinkRDI.dll

If your development system doesn't include a JTAG emulator, use the simulator for this exercise.

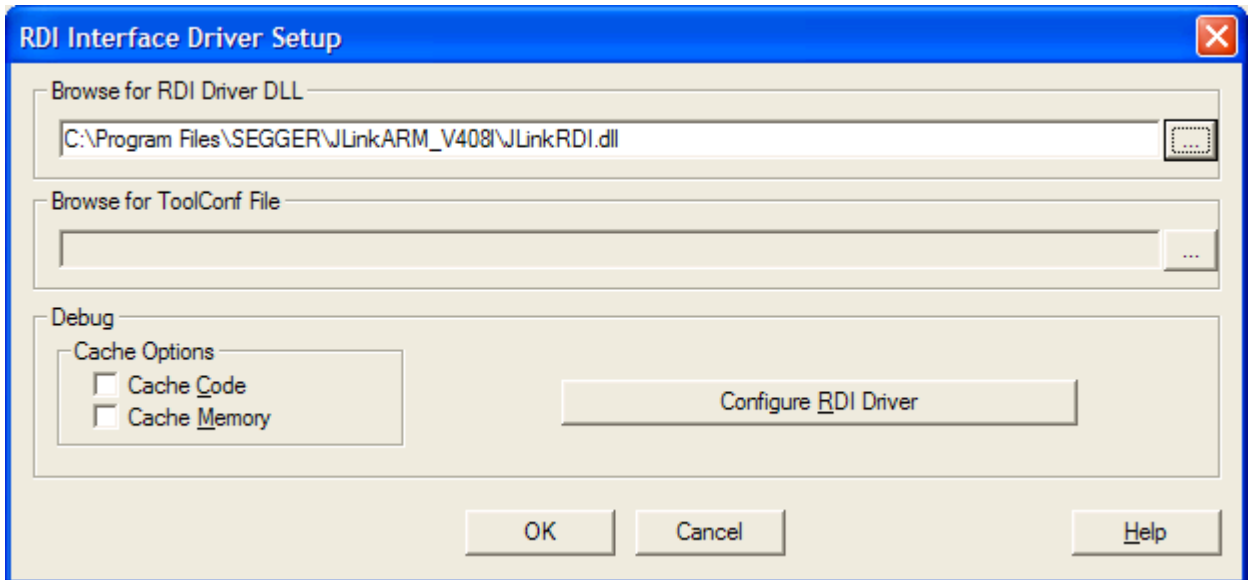
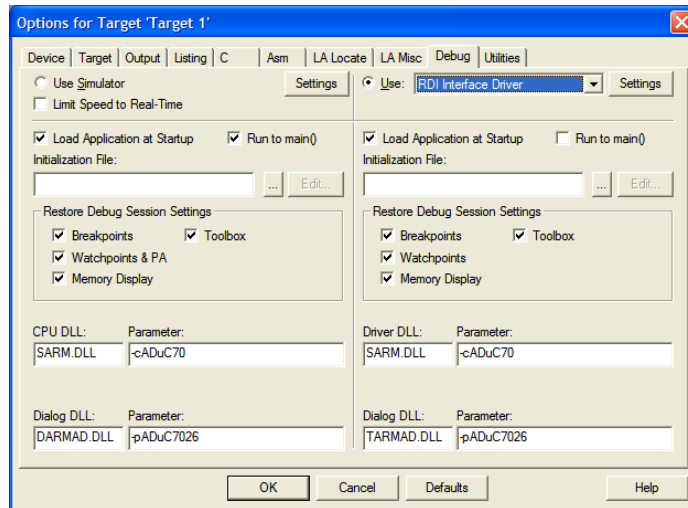

- a. Select the “configure RDI Driver” button. And in the “Flash” panel, clear the “Enable Flash programming” option. Everything else in this window should be disabled.

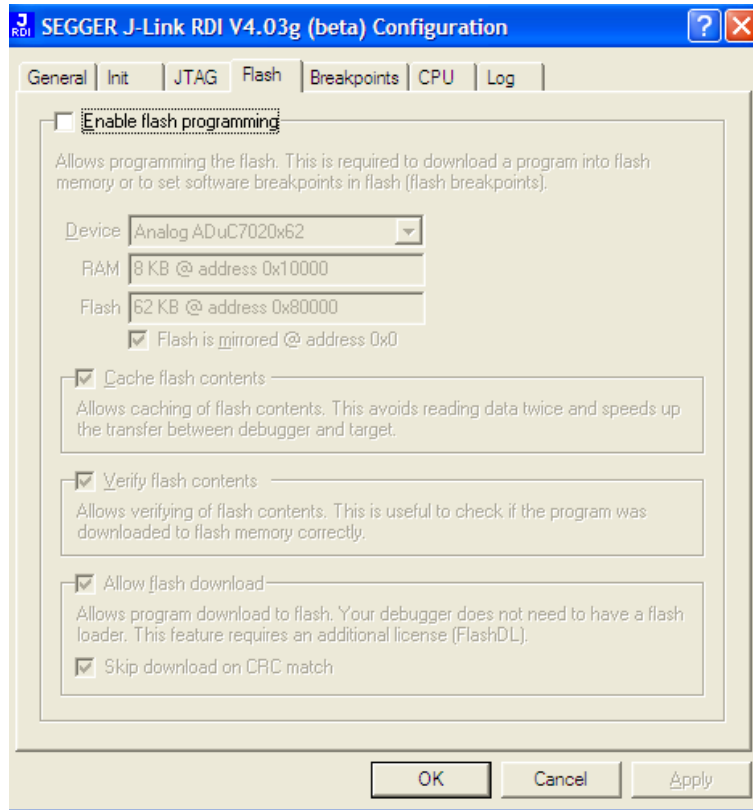

In the “JTAG” tab, ensure the JTAG speed is set to 600KHz. See the screenshot below.

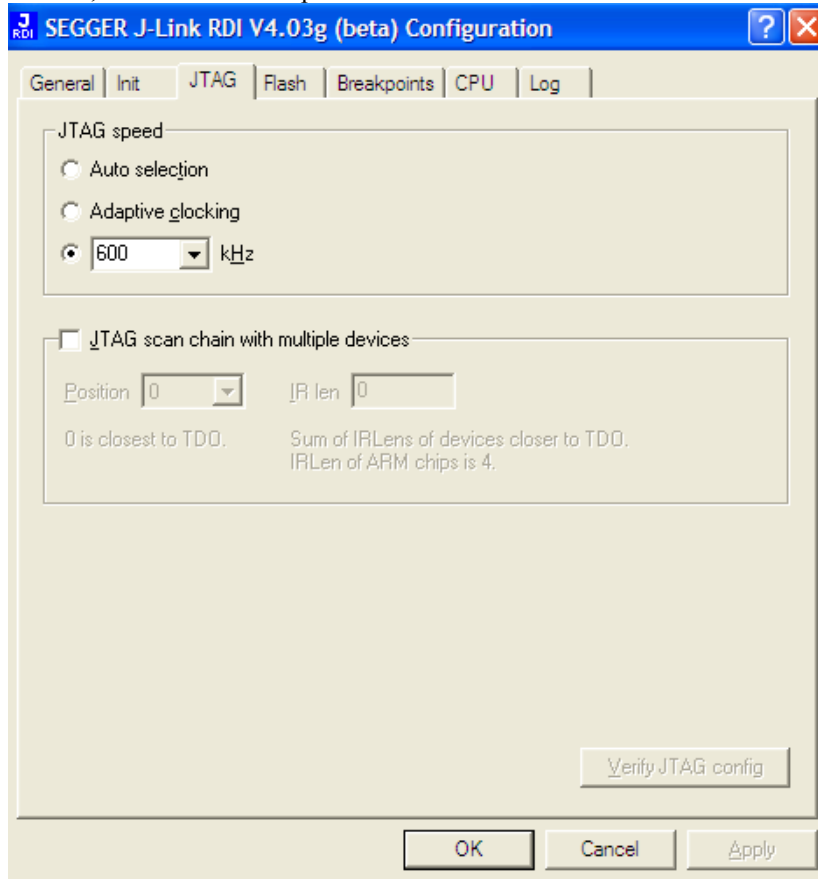

In the “Breakpoints” tab, ensure “Software Breakpoints” are enabled.

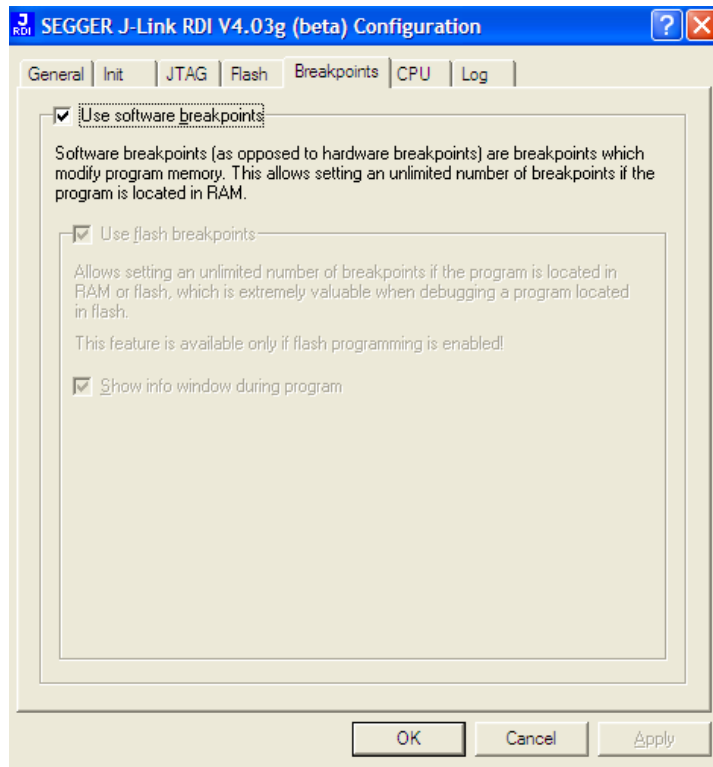

In the “CPU” window, ensure it is configured like the following screenshot:

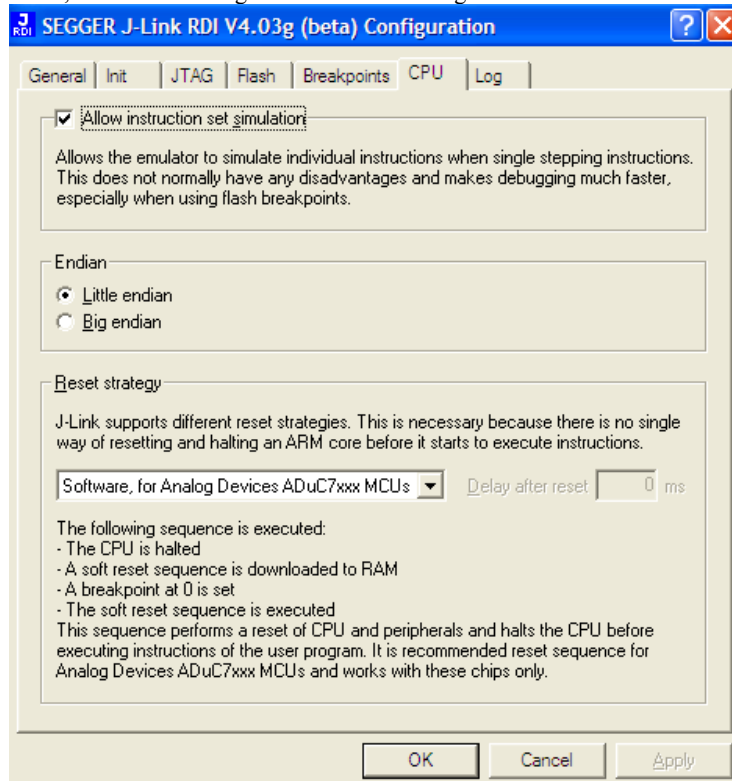

- b. In the “Utilities” panel, select “Use Target Driver for Flash Programming”, chose “RDI Interface Driver” and tick the option “Update Target before Debugging”.

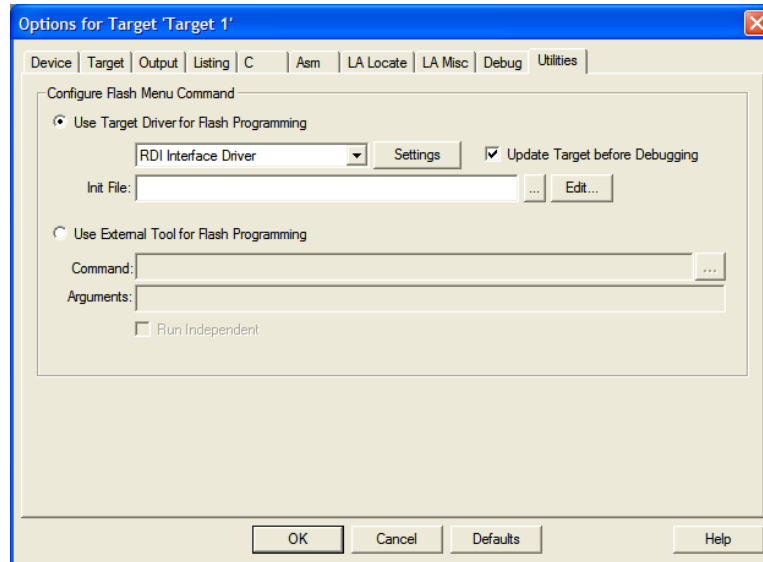

Hit the “Settings” option and the following dialog box will appear – “ $\mu$ Vision Flash Programmer” and press “Ok”.

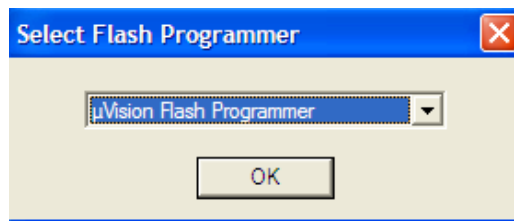

Then, a new dialog window will appear as below.

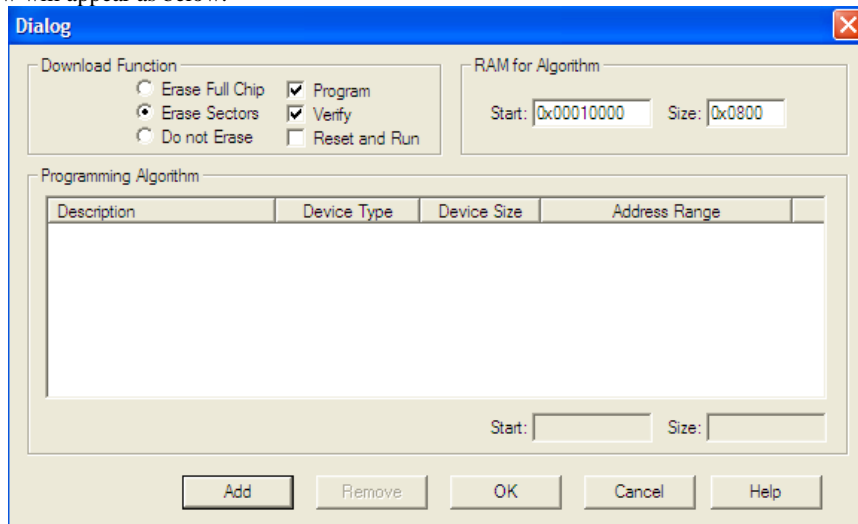

Select “Add” for the next window. Select “ADuC702X Flash (v1.1) and press “Add”

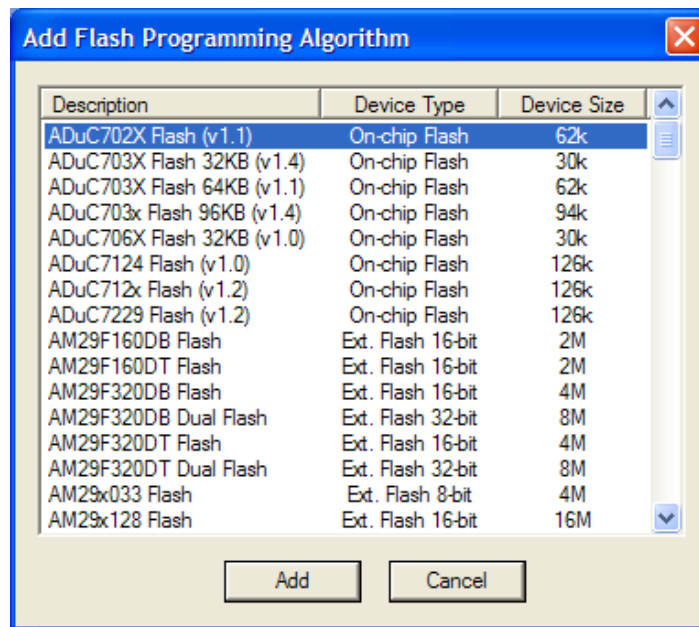

Then the following window will appear – Press “ok” at this point.

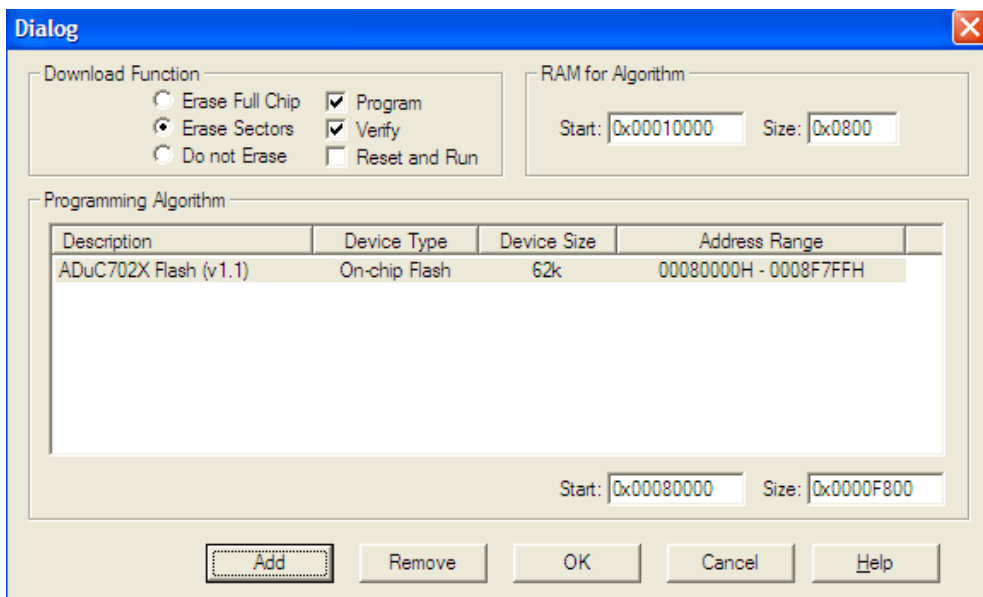

- c. Press OK again, all the options should be properly configured to compile, assemble, link, download and debug using mIDAS-Link or the simulator.

## 2.5 Adding Project files

- a. All the files relative to the project will be in the folder C:\ADuC7XXXV0.2\ADuC7023\Code\Realview\Demo.
- b. From Windows Explorer or any other way, copy the files C:\ADuC7XXXV0.2\ADuC7023\Code\Realview\Demo\Demo.c, irq\_arm.c and ADuC702x.s into the following directory C:\Keil\ARM\Examples\ADIdemo.

To add the files to the project right click on the “Source Group” folder in the “Project Workspace” and select “Add Files to Group”.



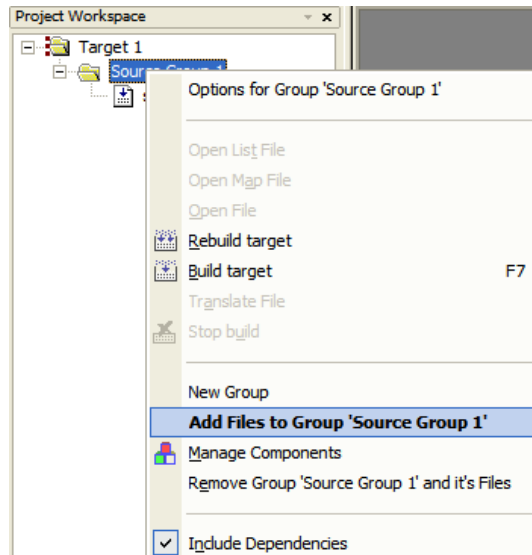

Note that you can use under Project the option “Component, Environment, Books” to rename the target and add the file relative to your project.

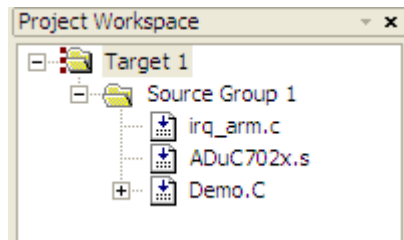

- c. Double click on the file name (Demo.c) in the Workspace window to open the source file.

## 2.6 Assembling/Compiling Code

- a. To compile/link Demo.c click on the  (translate current file) icon in the toolbar. The file should compile correctly and the following will be seen in the status window. If there are errors in your source code these will appear in the status window. To identify the line of code which corresponds to the error double click on the error in the Output window and an arrow will appear highlighting the line of code in which the error appears.

The ADuC7023.h file will automatically be included under Demo.c in the Project Workspace window.

- b. Before the code can be downloaded to the MicroConverter the entire project must be built. This is done by clicking on the  (rebuild all target files) icon on the toolbar. It will also create a pot.elf file used by the debugger.

```

x Build target 'Target 1'
  compiling irq_arm.c...
  assembling ADuC702x.s...
  compiling Demo.C...
  linking...
  Program Size: Code=1516 RO-data=16416 RW-data=24 ZI-data=1760
  "GPIO.axf" - 0 Error(s), 0 Warning(s).
    
```

## 2.7 Downloading/Debugging Code

- a. Check on the evaluation board that S1.3 and S1.8 is in ON position for the DAC1 and POT.

- b. To start debugging, select Start/Stop Debug in the Debug dropdown menu or press the icon  (Start/stop debug session). The debugger will indicate that you are using an evaluation version. Press OK.

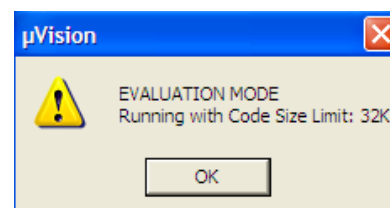

- c. From the Peripheral pull down menu, select Digital/Analog Converter, DAC1 and select Analog/Digital Converter.

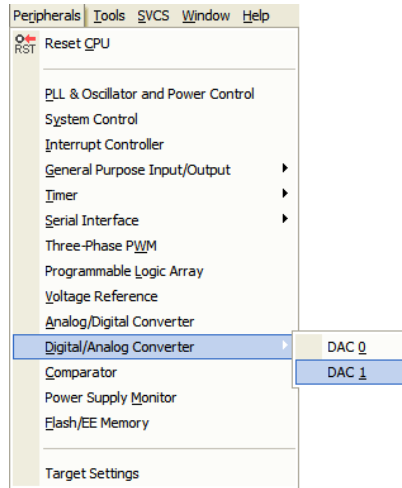

The following windows will appear:

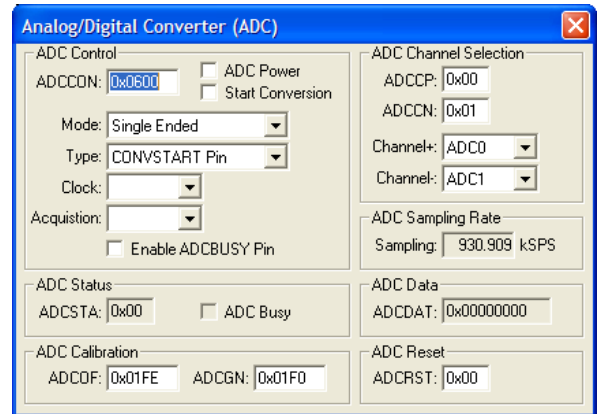

- d. Close the disassembly window. Go to Demo.c file. Set a breakpoint on the instruction `ADCCON = 0x6A3;`. This is done by right clicking on the line of code and then selecting “insert/remove breakpoint” or by double clicking on the left of the instruction. Notice that the breakpoint is indicated by a large red dot to the left of the line.



```

19          on DAC1 output. This has the affect of controlling the
20          brightness of the LED, D1.
21          Ensure "POT" and "DAC" switches of S1 are "On"
22          *****/
23 #include <aduc7023.h>
24 unsigned int uiPLLST = 0;
25 volatile unsigned int ucTest = 0;
26
27 void ADCpoweron(int);
28 int main(void)
29 {
30     POWKEY1 = 0x01;           // Configure CPU Clock for 41.78MHz, CD=0
31     POWCON = 0x00;
32     POWKEY2 = 0xF4;
33
34     DAC1CON = 0x13;          // Set DAC1 output to 0-AVDD range and turn DAC1 on
35     ADCpoweron(20000);      // power on ADC
36     ADCCF = 0x00;           // select ADC channel 0
37     REFCON = 0x01;          // internal 2.5V reference. 2.5V on Vref pin
38
39     while (1)
40     {
41         ADCCON = 0x6A3;      // software conv., single-ended, conv. enabled
42         while (!ADCSTA){}    // wait for end of conversion
43         DAC1DAT = ADCDAT;    // result format is identical for DAC and ADC
44     }
45 }
46
47 void ADCpoweron(int time)
48 {
49

```

e. Press the run code button  twice. The ADCDAT and DAC1DAT values should be identical.

f. Change the value of the potentiometer press run and view the value of ADCDAT changing and the intensity of the LED changing. Remove the breakpoint, press run. When moving the potentiometer the intensity of the LED changes.

g. To stop the code running press  and to stop debugging press .

### (3) IAR EMBEDDED WORKBENCH IDE

The IAR Embedded Workbench IDE (EWARM) integrates all the tools necessary to edit, assemble and debug code via JTAG

#### 3.1 Installing the IAR Embedded Workbench

To install the IAR Embedded Workbench software, follow these instructions.

Post installation of the ADuC7XXX CD the IAR Embedded Workbench installation executable needs to be manually selected. This executable is found at C:\ADuC7XXXV0.2\Applications\IAR\EWARM-KS-WEB-5407.zip. The IAR Embedded Workbench should be installed at C:\Program Files for this installation to function correctly. Post installation a license key is required from IAR in order to operate the evaluation software. Once IAR has been downloaded, double click on the file copy.bat located at C:\ADuC7XXXV0.2\Applications\IAR. This will copy across the latest ADI Generics information not yet available in the latest release of IAR Embedded Workbench.

Before the installation is complete, you will need to register on the IAR webpage. To register, go to the “downloads” page and select the “ARM KickStart version” for download – this will result in the registration page being displayed for you. Note, you do not need to download a new version of the IAR evaluation software for ARM7 parts. The version 5.407 on this CD is recommended as this version is compatible with the IAR example code provided on the CD.

#### 3.1.1 Installing the IAR Embedded Workbench support for the ADuC7124/26, ADuC7029, ADuC7023 and ADuC7122

Once IAR has been downloaded, double click on the file copy.bat located at C:\ADuC7XXXV0.2\Applications\IAR. This will copy across ADI Generics information not included in this release of IAR Embedded Workbench.

#### 3.2 Starting IAR Embedded Workbench

- From the “START” menu choose All Programs → IAR systems → IAR Embedded Workbench for ARM Kickstart → IAR Embedded Workbench. This loads the IAR Embedded Workbench IDE. The following window will appear, close it.

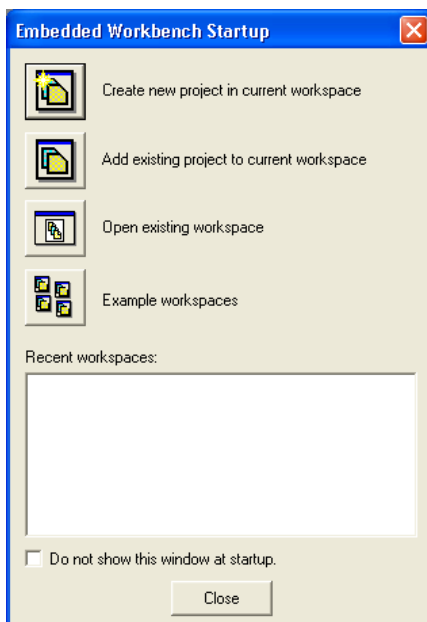

#### 3.3 Starting a project in an existing workspace

workspace and select IAR Code Example.cvw, now browse to an existing project directory.

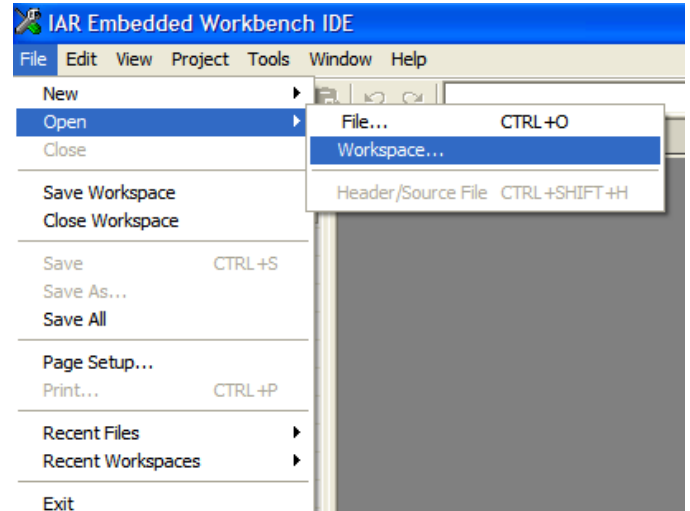

All the code examples given on this CD are part of this workspace:

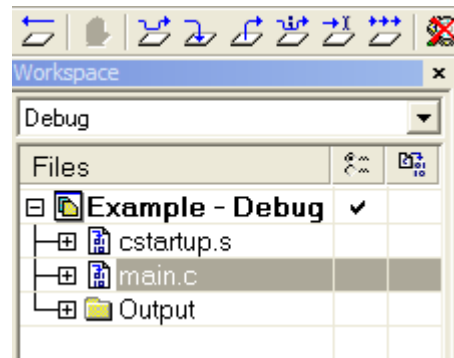

- From the project menu select Create New Project as shown below and choose Empty Project in the Project Template list. Press OK.

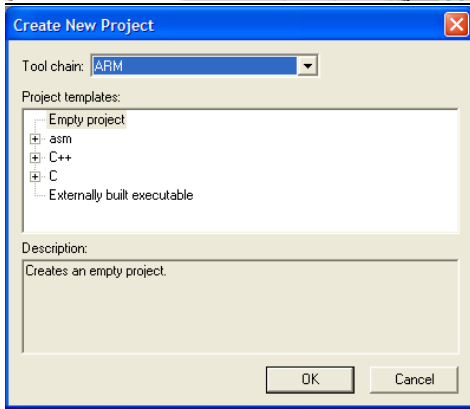
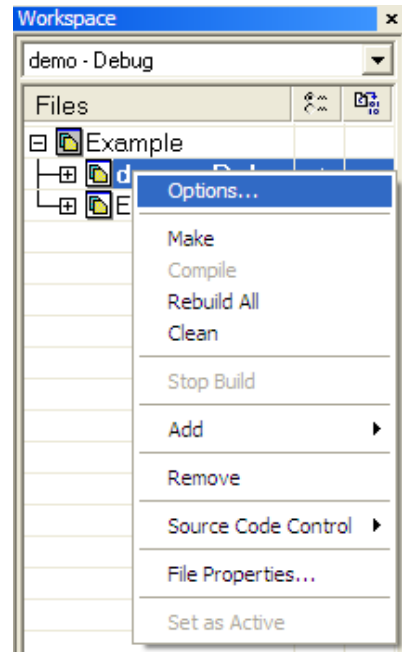
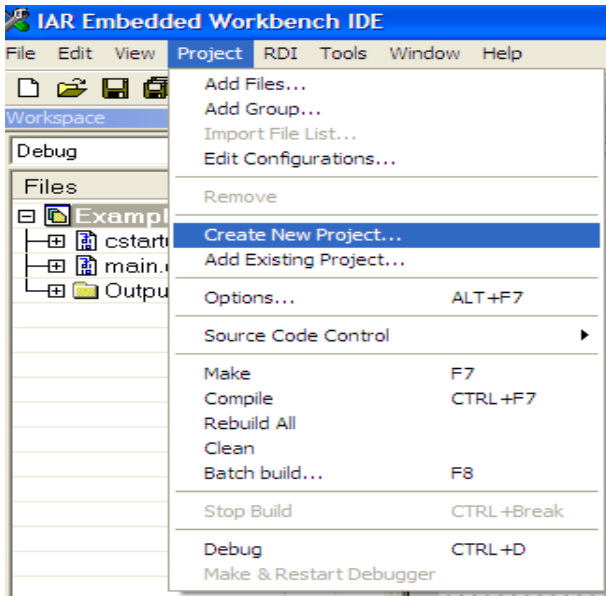

4. Name the new project “Demo” and save it under C:\ADuC7XXXV0.2\ADuC7122\Code\IARexamples\Demo. The new project will automatically appear in the workspace.

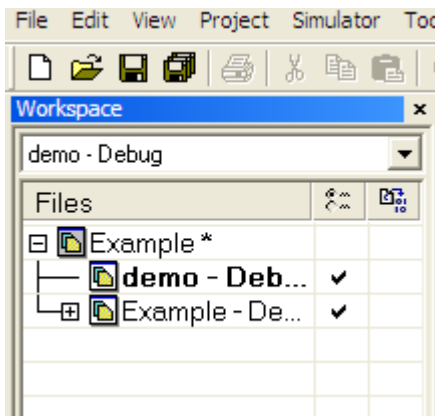

5. Right click on “Demo” in the workspace and select add files. Add Timer.c and cstartup.s from the Timer folder under IARexamples. Note that you need to change “file of type” to “all file” to add cstartup.s

6. Right click on Demo in the workspace and select options.

The following window appears: change the processor variant to device and choose the device that you have in your development system. In the “category” list, select “linker”.

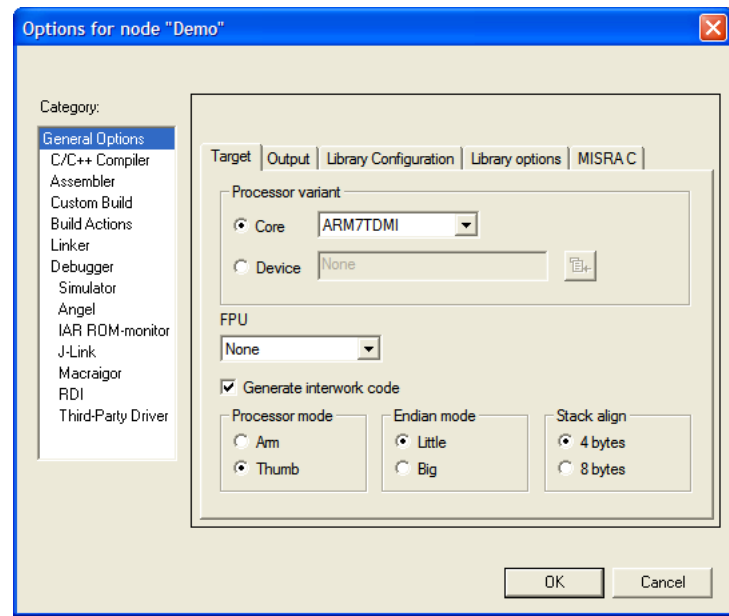

### 3.4 Configuration for the mIDAS-Link

7. Select Override Default in the linker command file box and choose the file “ADuC7122\_Flash\_Standalone.icf” under: C:\ProgramFiles\IARSystems\EmbeddedWorkbench5.4 Kickstart\ARM\examples\AnalogDevices\SupportFiles.

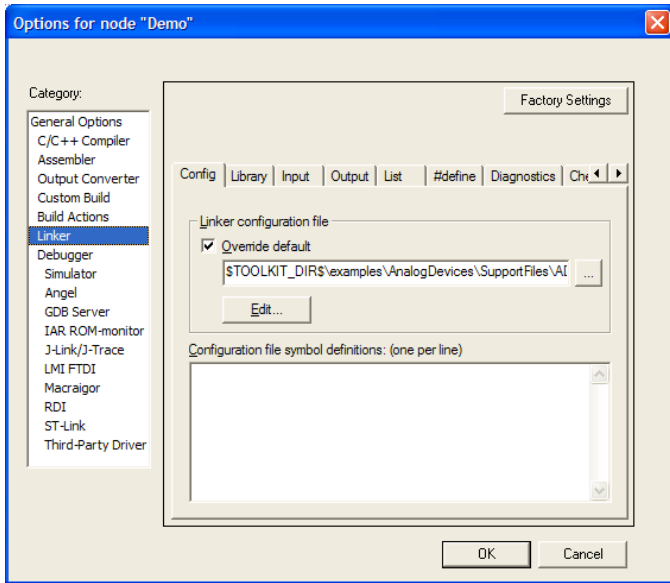

8. In the Debugger options, select the Setup panel and choose J-LINK/J-TRACE as driver. Also check the override default tick box under the device description file heading and set the path as follows  
 \$TOOLKIT\_DIR\$\CONFIG\debugger\AnalogDevices\ioaduc7122.ddf. Configure menus as follows.

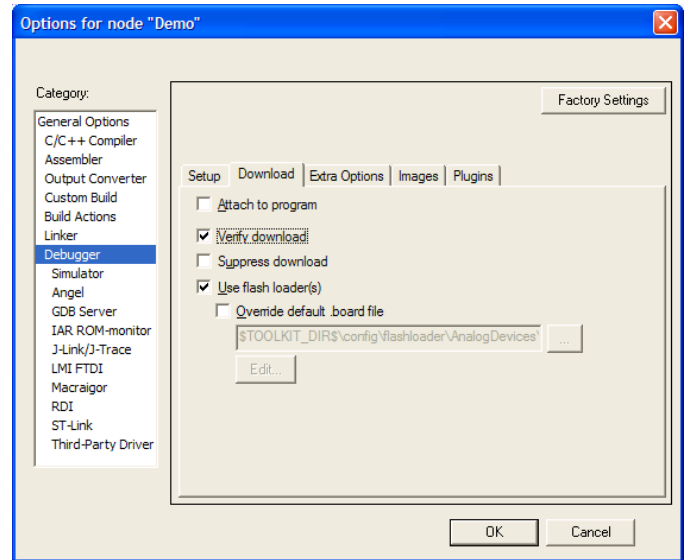
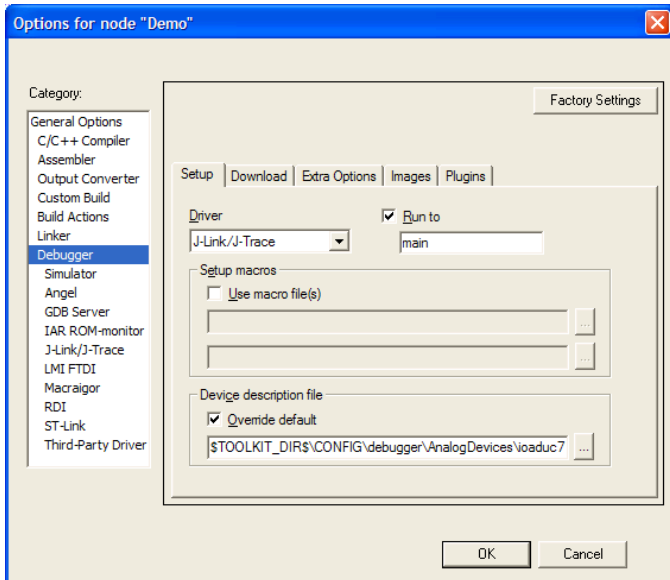

9. In the J-LINK/J-TRACE panel, set the reset type as software and configure the JTAG speed to 750 kHz. Press OK, the project is now configured to debug via the mIDAS-Link.

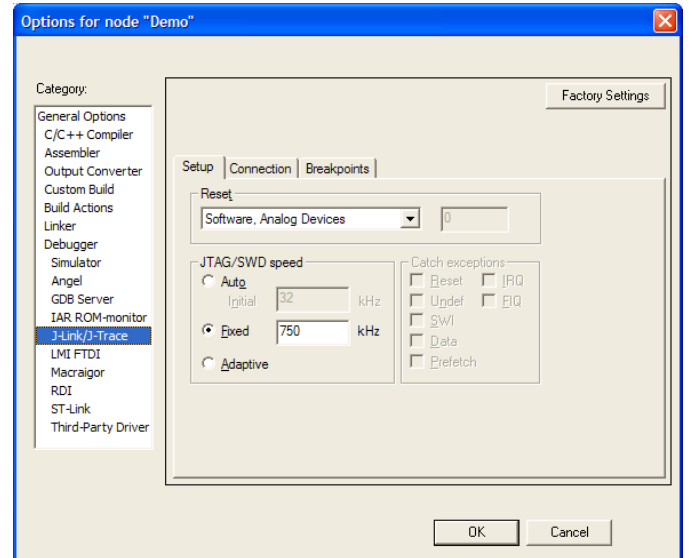

10. To start debugging press the icon or select Debug in the Project dropdown menu.

## (4) THE WINDOWS I2C DOWNLOADER

The Windows I2C Downloader for ARM based part (I2CWSD) is a windows software program that allows a user to download Intel Extended Hex files as created by assembler/compiler to the MicroConverter via the I2C port. The Intel Extended Hex file is downloaded into the on-chip Flash/EE program memory via a USB-I2C dongle (MCV COMBI DONGLE) in the case of this evaluation kit.

For the ADuC7023 evaluation board, no dongle is required to program the part via USB. But, the ADuC7023 specific version of I2CWSD must be used. This version is located in the following folder: C:\ADuC7XXXV0.2\Documentation\ADuC7023\EvalDoc\ADuC7023 Eval board Programming

### 4.1 Opening the I2CWSD

1. Power up the evaluation board using the USB interface.
2. Connect the MCV COMBI dongle to your PC via the USB interface. Note, for the ADuC7023 evaluation board, there is a specific I2CWSD application that does not require the MCV COMBI dongle only the USB cable.
3. Connect the 4-pin I2C header of the dongle to the temporary I2C header of the ADuC7023 evaluation board.
4. Ensure that Flash address 0x80014 is erased (equal to 0xFFFFFFFF).
5. The user should put the MicroConverter into I2C download mode using the following sequence:

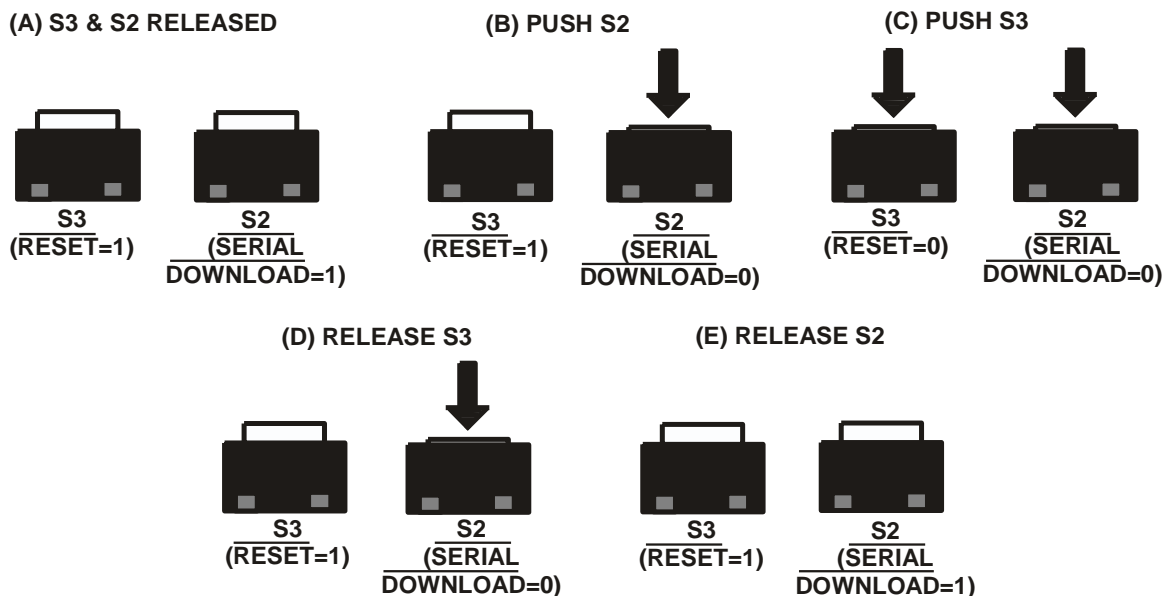

6. From the START menu choose Programs → ADuC7XXXV0.2 → I2CWSD. This launches the I2C Downloader application. The I2CWSD executable is located at c:\Program Files\Analog Devices Inc\MultiDongle\I2CWSD\I2CWSD.exe. Alternatively it can be launched from “start → all programs → Analog Devices Inc → I2CWSD.

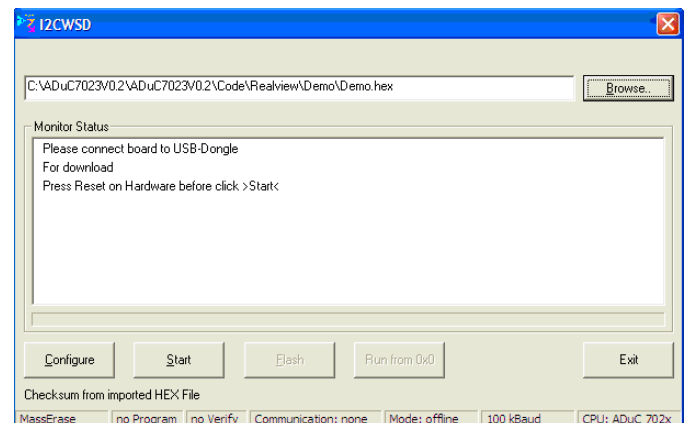

### 4.2 Downloading using I2CWSD

7. Select the file at C:\ADuC7XXXV0.2\ADuC7023\Code\Realview\Demo\demo.hex.

8. Press the Configure button and in the Flash panel select “Mass Erase” and “Program”. Press OK.
9. Press the Start button. The I2CWSD automatically sends the reset command to the MicroConverter. If the MicroConverter is in I2C download mode and the comms between the PC and the evaluation board are setup correctly, then the text “Connected to ADuC7023..” should appear.
10. Press the “Flash” button to start downloading the hex file. A progress bar while appear when the file is downloading. Once the file has been successfully downloaded monitor status box will be updated with “Download Complete Click Run to run program”.

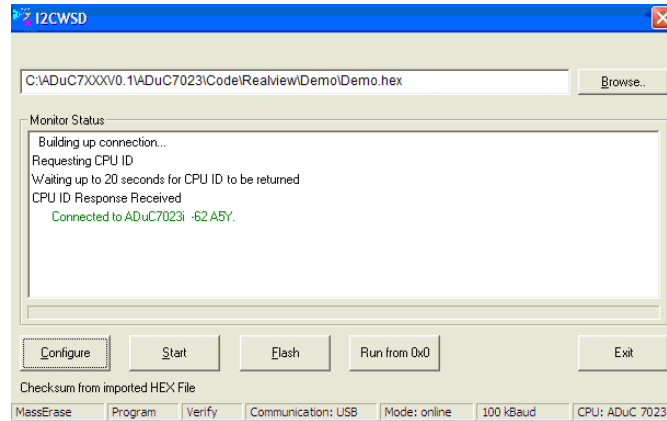



## (5) ELVES

### 5.1 Using Elves.exe with IAR Embedded Workbench

- In IAR Embedded Workbench IDE, using the previous example, select Elves in the Tools pull down menu. On first use a text file will be launched explaining how to setup this tool. Click on the setup button, check the path of the browser and select details. Exit this window.

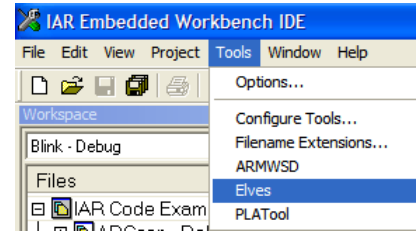

- In the Select Library, a list of library should be visible. Choose LibDac702x.h.

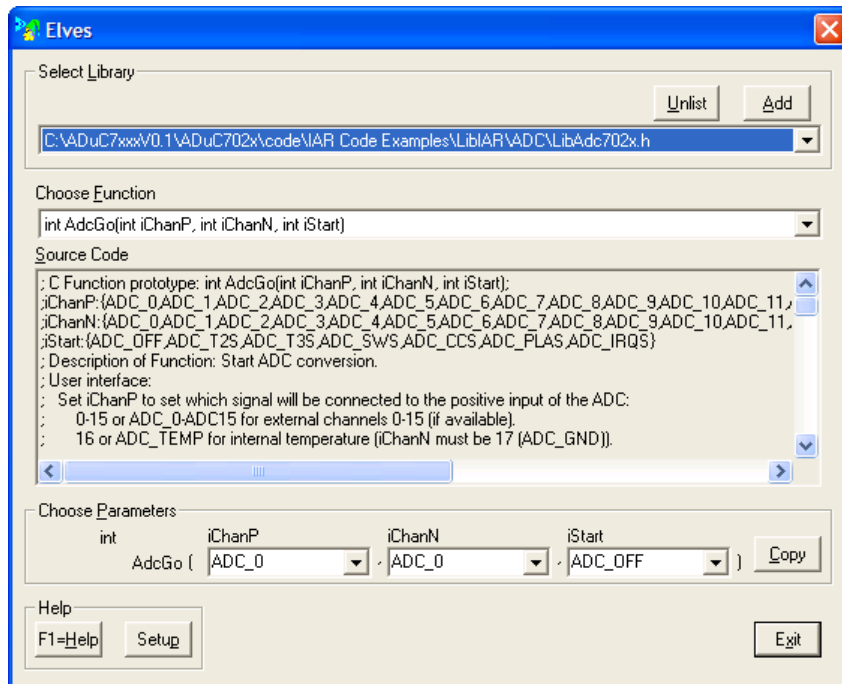

- In the Choose function, select int DACRng(). You can now see a description of the function and the code. Fill the parameters, channel 1 and AVDD\_RNG. Press the copy button. In your C code, replace DAC1 configuration by the function (right click and paste).
- Repeat this with int DacOut() function, channel 1 and value = ADCDAT. Replace the line DAC1DAT = ADCDAT with DacOut function.
- In the project workspace add the file libDAC702x.79 that is under C:\ADuC7XXXV0.1\ADuC702x\code\IAR Code Examples\LibIAR\DAC. In the main code include the two files:  

```
#include "C:\ADuC7XXXV0.2\ADuC702x\code\IAR Code Examples\LibIAR\DAC \libDac702x.h"
```
- Other functions are also available under : \ADuC7XXXV0.2\ADuC702x\code\IAR Code Examples\LibIAR.

### 5.2 Using Elves.exe with uVision3

The Elves can also be used in a similar way under Keil uVision3. Select Elves under the Tools pull down menu.

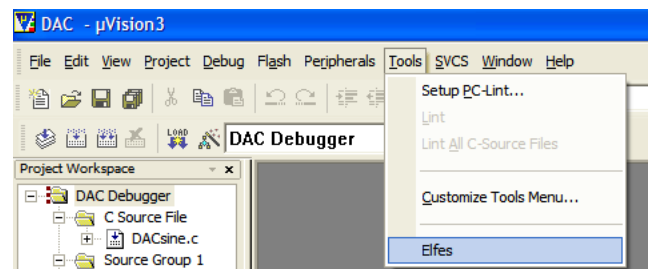

In pot.c add the following files:  

```
#include "C:\ADuC7XXXV0.2\ADuC702x\code\RealView Code examples\LibKeil\DAC \libDac702x.h"
```

And in the option for target, under linker, add the name and path to the library:

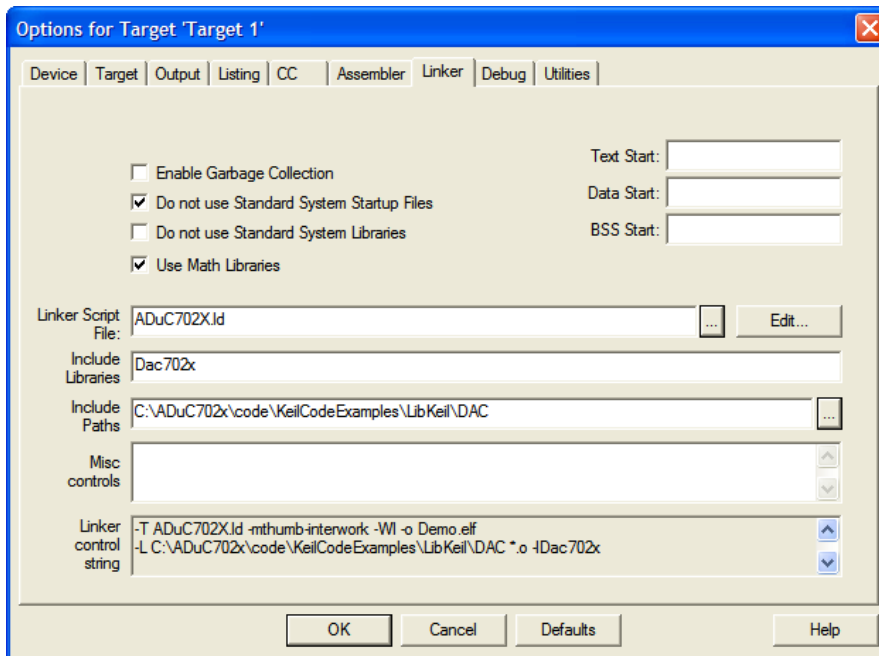

## (6) PLA TOOL

The PLA tool is a graphical tool allowing configuring the PLA easily.

The following example is part of the code example, PLA, under Code\KeilCodeExamples.

The code generated corresponds to the file PLAinit.c of ADCPLA code example. ADC conversion will occur if P1.2 is high and PLADIN bit 2 is set. Note that the ADC must be configured to start conversion on a PLA start convert signal. More comprehensive examples are in the PLAtool help.

### 6.1 Opening the PLATool

1. Launch PLAtool.exe from the START menu under All Programs → ADuC7XXX → PLAtool or from c:\ADuC7XXXV0.2\Applications\PLAandElves\PLAtool\_V2.5\_Setup.msi and select a part number.
2. Select ADuC7020 and press OK. The window below appears.

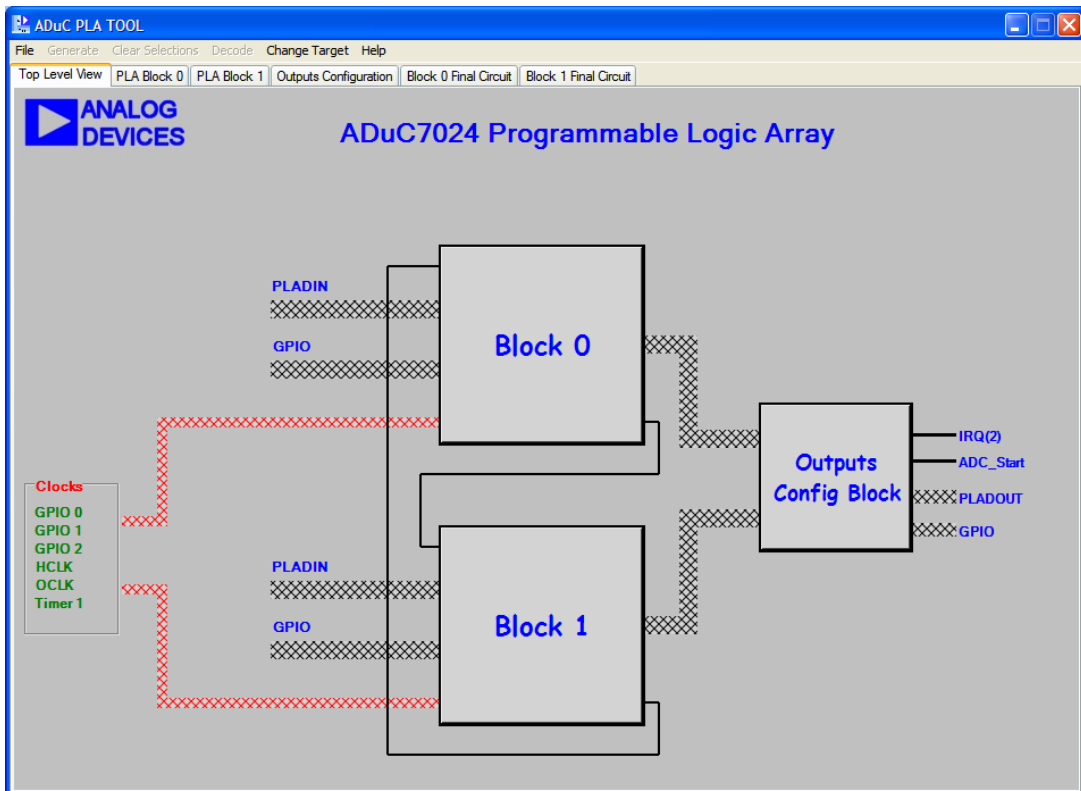
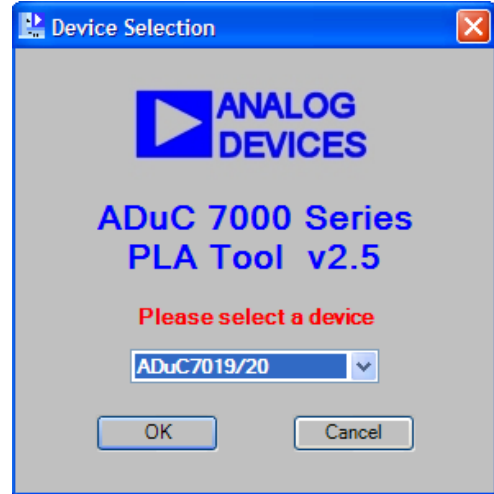

### 6.2 Configuring the gates and output

3. Select block 0.

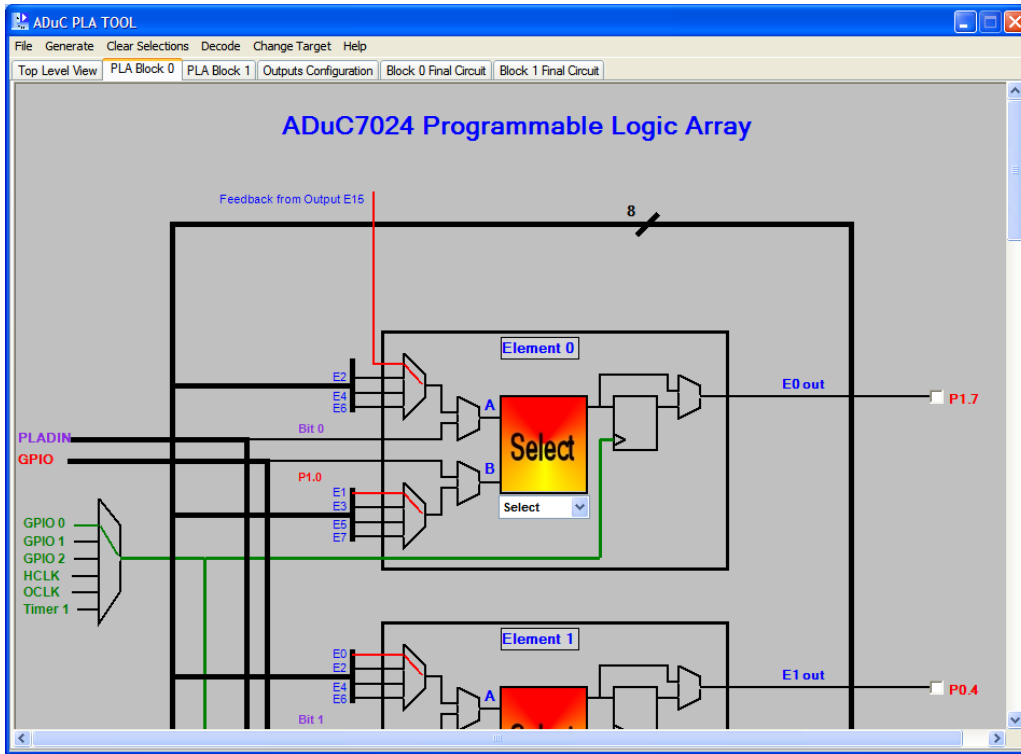

4. Select AND gate for element 2, with multiplexer A on Bit 2 bus i.e. MMR PLADIN and multiplexer B on P1.2. Choose to bypass the flip flop. Select the "Output" panel, scroll down and choose to start an ADC conversion using element 2 output.

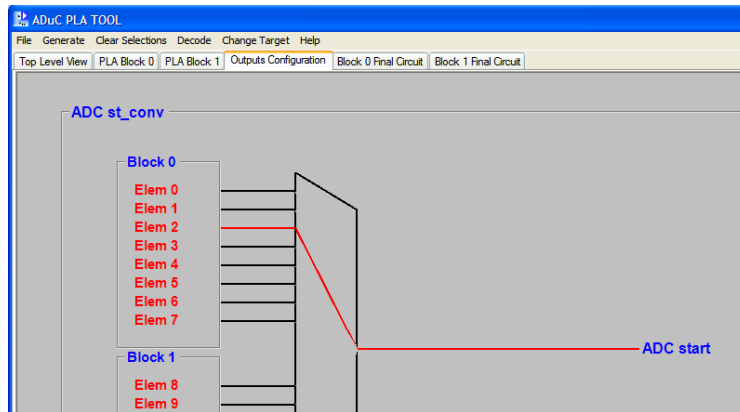

The PLA peripheral is now configured as in example ADCPLA.

### 6.3 Generating C code

5. Select Generate → Code → C Code.

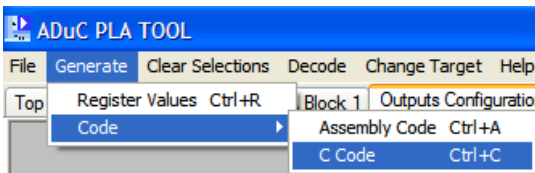

The code generated corresponds to the file PLAINIT.C under C:\ADuC7XXXV0.1\ADuC702x\code\RealView Code examples\PLA.

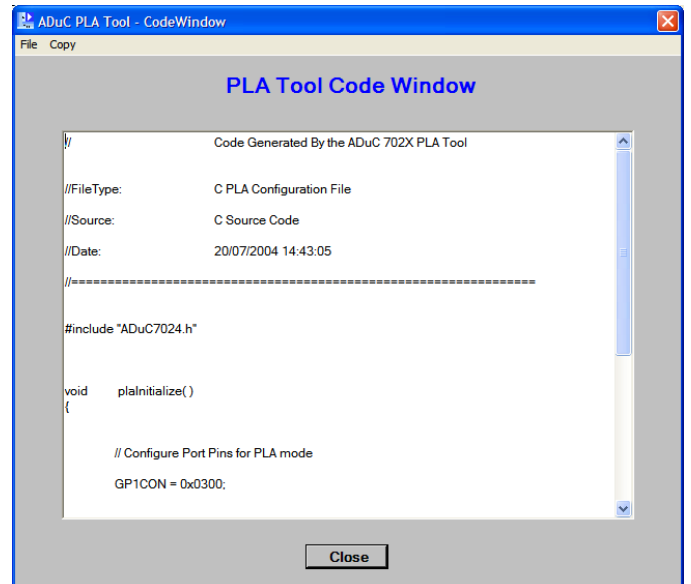

## (7) THE WINDOWS SERIAL DOWNLOADER

The Windows Serial Downloader for ARM based part (ARMWSD) is a windows software program that allows a user to serially download Intel Extended Hex files as created by assembler/compilers to the MicroConverter via the serial port. The Intel Extended Hex file is downloaded into the on-chip Flash/EE program memory via a selected PC serial port (COM1 to COM31).

### 7.1 Opening the ARMWSD

11. Power up the evaluation board using the 9V power supply. Connect the evaluation board header J1 to your PC's COM1 serial port using the RS-232 dongle cable provided. The PC serial COM port may be changed from COM1 via the WSD 'configuration' option...see section 4.3 below.
12. The user should put the MicroConverter into serial download mode using the following sequence:

**(A) S3 & S2 RELEASED**

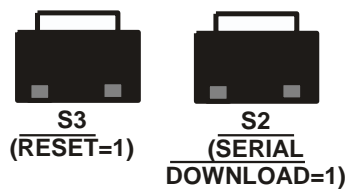

**(B) PUSH S2**

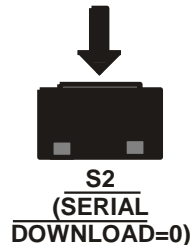

**(C) PUSH S3**

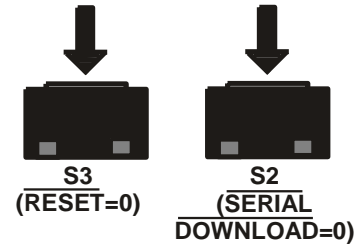

**(D) RELEASE S3**

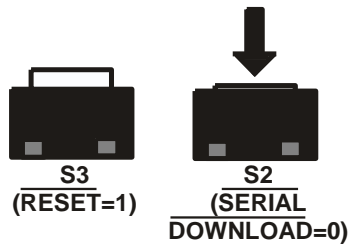

**(E) RELEASE S2**

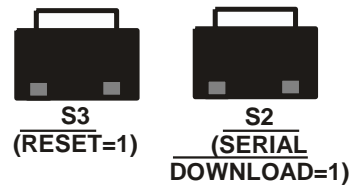

13. From the START menu choose All Programs → Analog Device Inc → ARMWSD. This launches the Windows Serial Downloader application. The ARMWSD executable is located at  
C:\ADuC7XXXV0.2\Applications\ARMWSD\ARMWSD.exe.

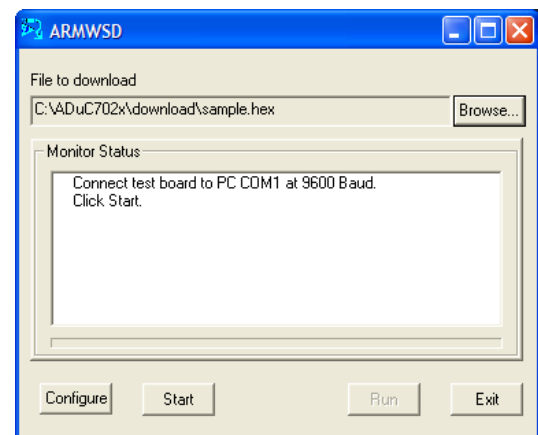

### 7.2 Downloading using ARMWSD

14. Select the file at C:\ADuC7XXXV0.2\ADuC702x\code\IAR Code Examples\Misc\blink.hex.
15. Press the Configure button and in the Parts panel select the part you are using. Press OK.
16. Press the Start button. The ARMWSD automatically sends the reset command to the MicroConverter. If the MicroConverter is in serial download mode and the comms between the PC and the evaluation board are setup correctly then the ARMWSD should start downloading the hex file and display a progress bar while the file is downloading. Once the file has been successfully downloaded monitor status box will be updated with "Download Complete Click Run to run program".

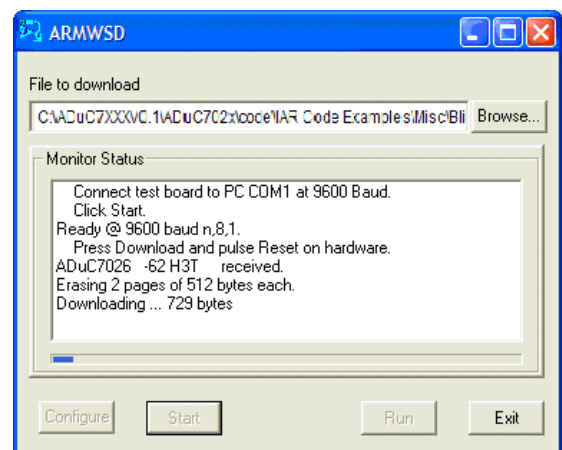

### 7.3 Running the downloaded file

#### Running using the ARMWSD

- Click the run button. The monitor status box will be updated with the message “Running. Click Start for new Download”. The program start running from 80000h (start of the Flash/EE).

#### Manual Run option

- Press RESET on the evaluation board with the SERIAL DOWNLOAD switch released. The program starts running automatically after reset as can be seen by the flashing LED.

### 7.4 Additional options

The ADuC702x family incorporates a serial download protocol that allows various options (see ARMWSD\_protocol technote). These options can be selected in the Configuration window as shown below.

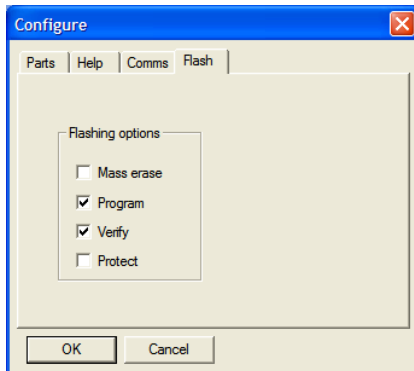
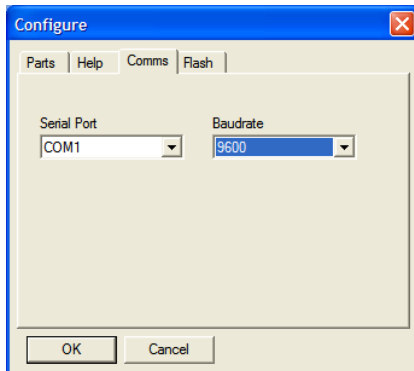
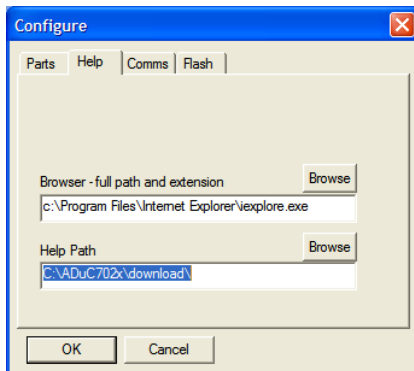

If the protect option is selected, another panel is available. Select the pages to protect, enter the key and press OK. Note that using the ARMWSD, only a mass erase will be able to erase the protection.

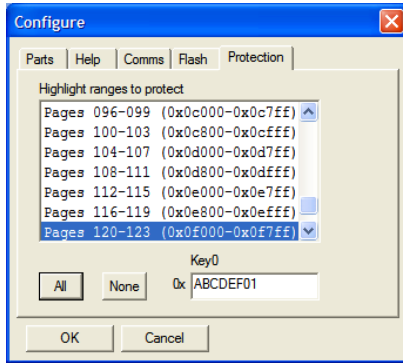

**NOTE: use of the PC COM port**

Only one application may use the PC serial port at any time. Close the ARMWSD before using any other application that uses the PC COM serial port

## (8) WINDOWS ANALOG SOFTWARE PROGRAM (WASP)

The Windows Analog Software Program (WASP) is a windows software program for all ADuC702x MicroConverter products that allows analysis of their analog performance.

This application is currently in beta sampling. ADI is not liable for the use of this software.

### 8.1 Setup

The WASP uses a mIDASLink emulator to configure the MicroConverter and to acquire results.

Usage of the mIDASLink emulator requires that the USB driver for this emulator be installed before use. Refer to Section **Tools installation options** in the first chapter for information about installing this driver if necessary.

Before launching the WASP, you should ensure that

- The mIDASLink emulator is connected to the PC via the USB cable.
- The USB driver for the mIDASLink emulator has been provided to Windows.
- The 20 way IDC mIDASLink emulator JTAG cable is connected to the IDC JTAG connector on your target board.
- The target board is powered up.

### 8.2 Usage

The WASP consists of three separate pages: **Connection**, **Configuration**, and **Results**.

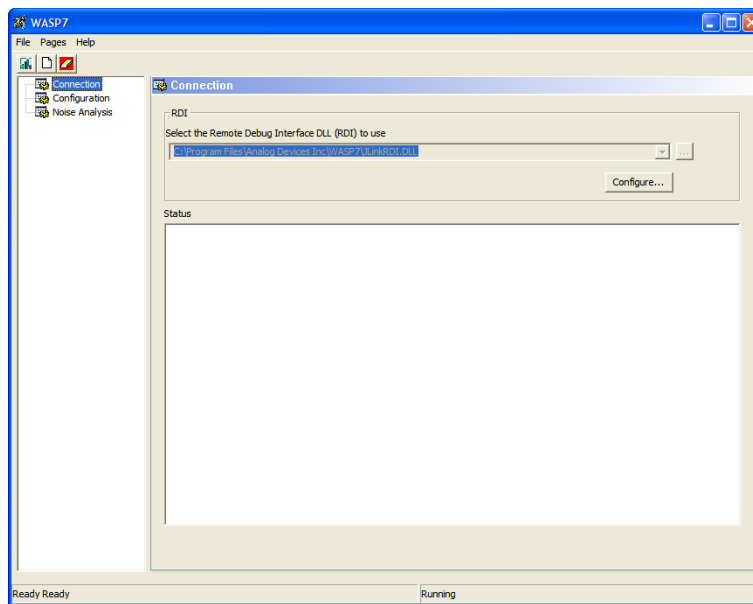

**WASP Connection Page**

The Connection Page contains information about any previous connection attempt and also the possibility to reconfigure the mIDASLink if required.

The information shown in the *Status* box on this page may be useful if the WASP failed to connect to the ADuC702x for any reason.

There is also the possibility to re-configure the mIDASLink via the *Configure* button. However, re-configuring will not normally be necessary as the WASP will use a suitable default set-up initially.



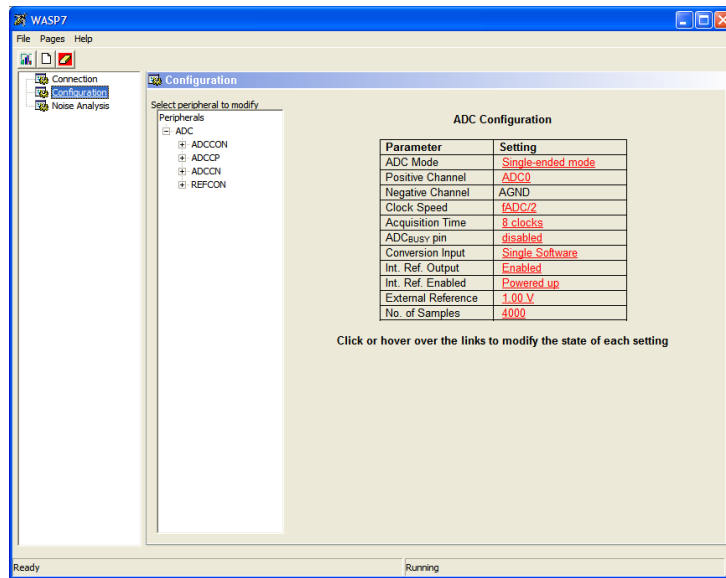

**WASP Configuration Page**

The **Configuration Page** allows the ADC to be configured according to the user's preference. The set-up described here will be used in any subsequent acquisition of results.

You can modify the current setting of any field by either clicking or hovering over an underlined link on the page.

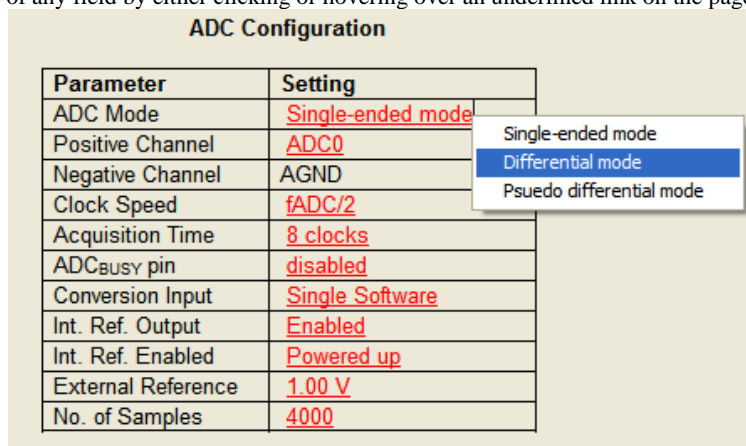

**Clicking on an underlined link.**

Clicking on a link brings up a menu from which the desired option can be selected.

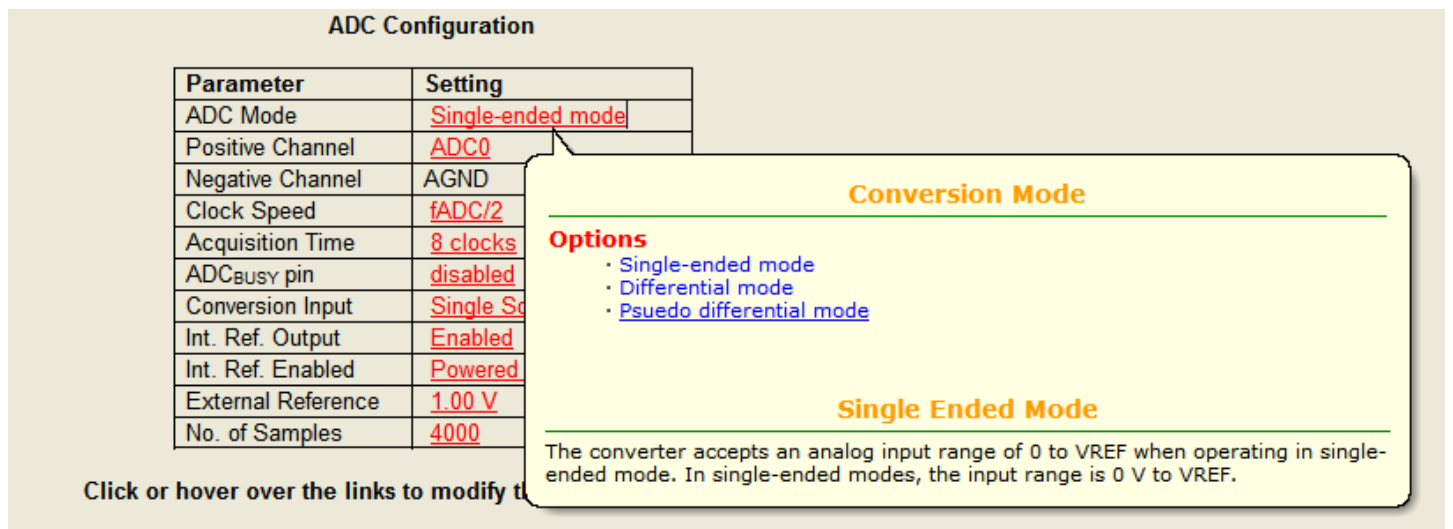

**Hovering over an underlined link**

Alternatively, hovering over an underlined link will bring up a descriptive balloon from which the desired option can be selected.

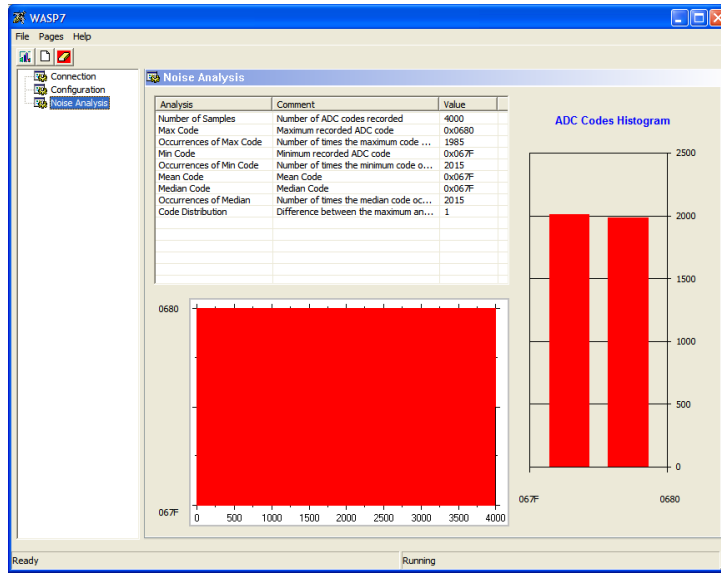

**WASP Results Page**

The **Results Page** shows the analysis of results from the last acquisition. The results analysis consists of the following

- A strip chart showing all results
- A histogram showing the relative frequency of acquired codes.
- Various statistics calculated from the acquired results.

Several toolbar buttons are also provided which perform some useful functions



**Acquire Results**

Connects to the MicroConverter and acquires results using the current configuration.



**Reset Configuration**

Reset the currently configured ADC configuration to a known default configuration.



**Clear Results**

Discards all currently acquired results.

Typical usage of the WASP program would involve the following

- Configure the ADC, using the **Configuration** page.
- Click the **Acquire Results** toolbar button.
- View results and analysis on the **Results** page.

## (9) LIN WINDOWS SERIAL DOWNLOADER

The applications LINBWS and LINHWS are a windows software program for the ADuC703x MicroConverter products that allows serial download of an Intel hex file to flash memory. The LINWS is automatically extracted and installed by the ADuC7XXX CD to C:\Program Files\Analog Devices Inc\MultiDongle\LINBWS and C:\Program Files\Analog Devices Inc\MultiDongle\LINHWS. Further information can be found at C:\ADuC7xxxV0.2\ADuC7034\_36\documentation\application notes\ADuC7032 LINWS Manual.pdf

**(10) INSTALLED DOCUMENTATION AND CODE DIRECTORY****Installed Documentation Directory**

Installing the MicroConverter<sup>®</sup> Development System CD installs documentation for the ADuC702x, ADuC706X, ADuC7034, ADuC7036, ADuC7039 and ADuC7122, ADuC7124/6 products at C:\ADuC7XXXV0.2\ documentation.