

Printed Circuit Board Mount Power Film Capacitors
C4AE, Radial, 2 or 4 Leads, 450 – 1,100 VDC
 for DC Link

Overview

The C4AE capacitors are polypropylene metallized film, with rectangular plastic box type filled with resin (white and grey color) and 2 or 4 tinned copper wires.

Applications

Typical applications include DC filtering and energy storage.

Benefits

- Self-healing
- Low losses
- High ripple current
- High capacitance density
- High contact reliability
- Suitable for high frequency applications

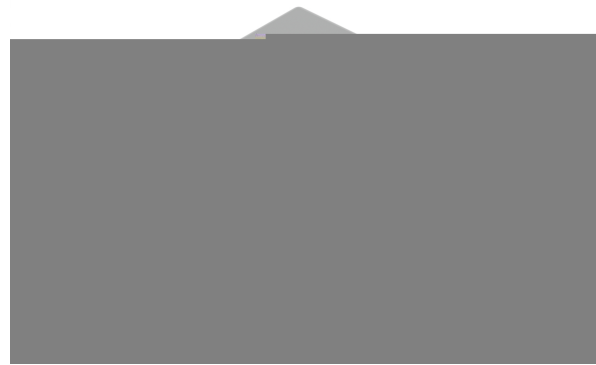

Part Number System

C4	A	E	Q	B	W	5270	A	3	N	J
Series	Type	Application	Rated Voltage (VDC)	Case	Terminals Code	Capacitance Code (pF)	C-Spec	Lead Diameter (mm)	Size Code: B x H x L (mm)	Tolerance
C4 = MKP Power Capacitors	A = Box, wire terminals	E = DC link	G = 450 H = 600 J = 700 O = 900 Q = 1,100	B = Box, plastic case	U = 2 pins W = 4 pins	Digits two – four indicate the first three digits of the capacitance value. First digit indicates the number of zeros to be added.	A = Standard grade	1 = 0.8 2 = 1.0 3 = 1.2	W = 11 x 20 x 31.5 X = 13 x 25 x 31.5 Y = 14 x 28 x 31.5 1 = 19 x 29 x 31.5 2 = 22 x 37 x 31.5 F = 20 x 40 x 42 J = 28 x 37 x 42 L = 30 x 45 x 42 M = 30 x 45 x 57.5 N = 35 x 50 x 57.5	J = 5% K = 10%

Dimensions – Millimeters

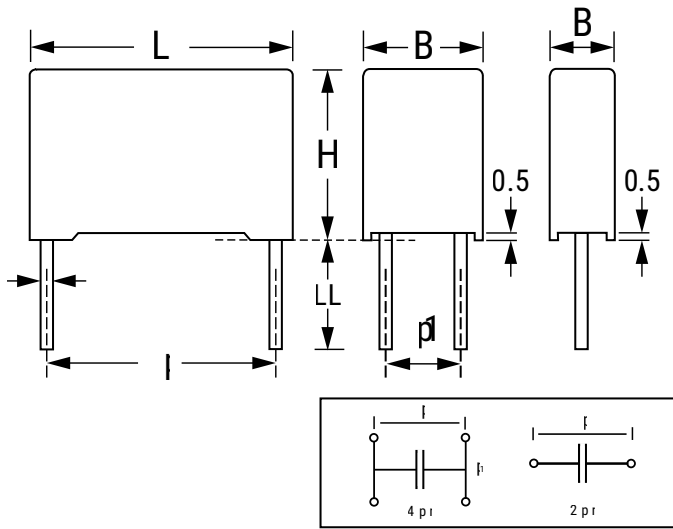

Size Code	p		p1		B		H		L		LL		d	
	Nominal	Tolerance	Nominal	Tolerance	Nominal	Tolerance	Nominal	Tolerance	Nominal	Tolerance	Nominal	Tolerance	Nominal	Tolerance
W	27.5	±0.4			11	+0.3	20	+0.2	31.5	+0.5	6	+0/-2	0.8	±0.05
X	27.5	±0.4			13	+0.3	25	+0.2	31.5	+0.5	6	+0/-2	0.8	±0.05
Y	27.5	±0.4			14	+0.3	28	+0.2	31.5	+0.5	6	+0/-2	0.8	±0.05
1	27.5	±0.4			19	+0.3	29	+0.2	31.5	+0.5	6	+0/-2	0.8	±0.05
2	27.5	±0.4			22	+0.3	37	+0.2	31.5	+0.5	6	+0/-2	0.8	±0.05
F	37.5	±0.4	5.1/10.2	±0.4	20	+0.4	40	+0.2	42.0	+0.6	6	+0/-2	1.2	±0.05
J	37.5	±0.4	10.2	±0.4	28	+0.4	37	+0.2	42.0	+0.6	6	+0/-2	1.2	±0.05
L	37.5	±0.4	20.3	±0.4	30	+0.4	45	+0.2	42.0	+0.6	6	+0/-2	1.2	±0.05
M	52.5	±0.4	20.3	±0.4	30	+0.5	45	+0.3	57.5	+0.8	6	+0/-2	1.2	±0.05
N	52.5	±0.4	20.3	±0.4	35	+0.5	50	+0.3	57.5	+0.8	6	+0/-2	1.2	±0.05

Qualifications

Reference Standards	IEC 61071, EN61071, VDE0560
Climatic Category	40/85/56 according to IEC 60068-1

General Technical Data

Dielectric	Polypropylene metallized film - non inductive self-healing property
Application	DC filtering/DC-Link
Climatic Category	40/85/56 IEC 60068-1
Maximum Operating Temperature	+105°C
Endurance Test	500 hours + 500 hours at $1.3 \times V_{NDC}$ at 85°C
Standard	

Life Expectancy

Life expectancy	100.000 hours at V_{NDC} at Hot spot temperature $T_{HS} = +85^{\circ}C$
Capacitance drop at end of life	-5% (typical)
Failure rate IEC 61709	≤ 300 FIT at V_{NDC} at Hot spot temperature $T_{HS} = +85^{\circ}C$

Test Method

Test voltage between terminals	$1.5 * V_{NDC}$ for 10 seconds or $1.65 * V_{NDC}$ for 2 seconds, at $+25^{\circ}C$
Test voltage between terminals and case	3.2 kVac 50 Hz for 2 seconds
Damp Heat	IEC 60068-2-78
Change of temperature	IEC 60068-2-14

Operative Voltage Derating

	Voltage (VDC)					Life Expectancy (hrs)
	500	650	800	1,100	1,300	
Operative Voltage at $70^{\circ}C$ (T_{HS})	500	650	800	1,100	1,300	100,000
Rated Voltage at $85^{\circ}C$ (T_{HS})	450	600	700	900	1,100	100,000
Operative Voltage at $105^{\circ}C$ (T_{HS})	350	450	550	700	850	2,000

Lifetime Expectancy/Failure Quota Graphs

Lifetime Curve $V_{NDC} = 450\text{ V-}$

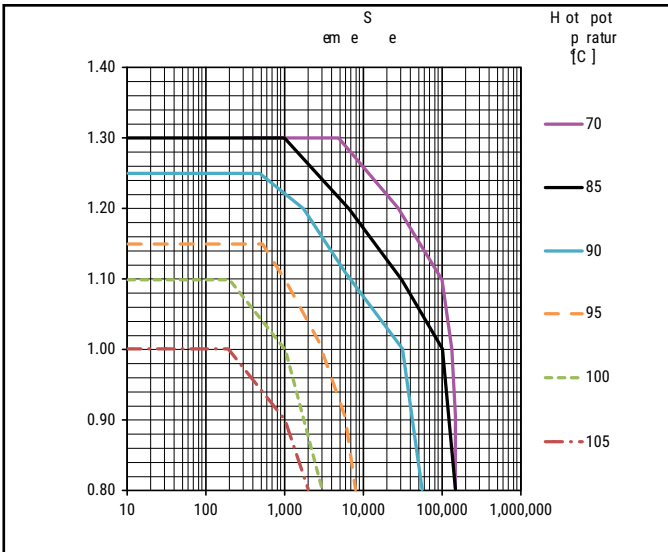

Lifetime Curve $V_{NDC} = 600\text{ V-}$ and $V_{NDC} = 700\text{ V-}$

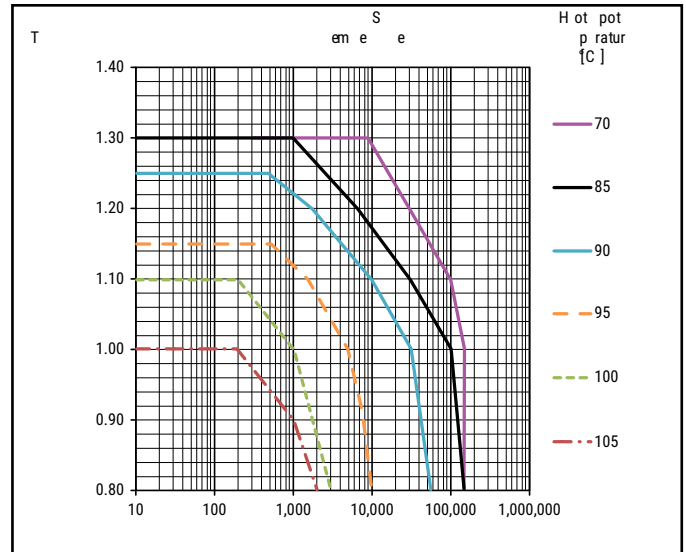

Lifetime Curve $V_{NDC} = 900\text{ V-}$ and $V_{NDC} = 1,100\text{ V-}$

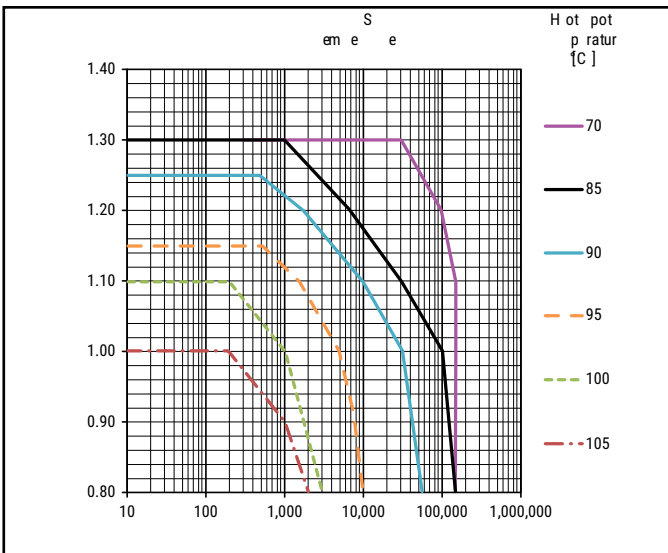

FIT at Hot Spot Temperatures

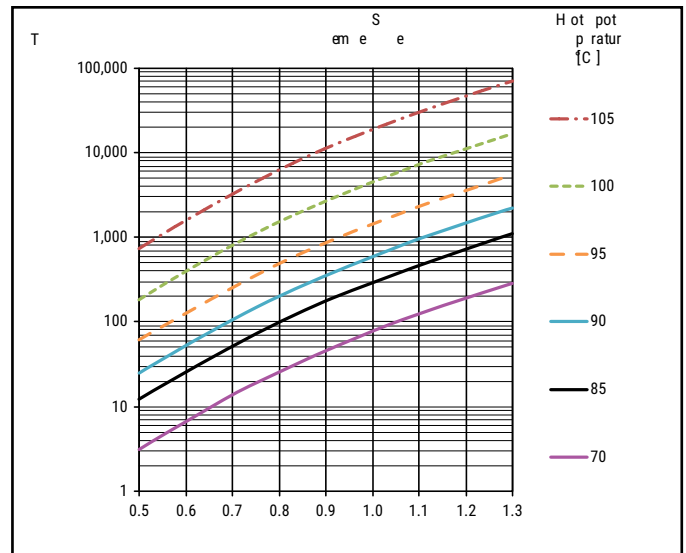

Notes:

$$T_{HS} = T_{AMB} + \Delta T$$

$$\Delta T = ESR * I_{rms}^2 * R_{th}$$

$$I_{rms} \text{ sh}$$

Environmental Compliance

As an environmentally conscious company, KEMET is working continuously to improve the environmental effects of both our capacitors and their production.

In Europe, due to the RoHS Directive, and in some other geographical areas such as China, legislation has been put in place to prevent the use of some hazardous materials, including lead (Pb) in electronic equipment. All products in this catalog are produced to help our customers' obligations to guarantee their products to fulfill these legislative requirements. The only material of concern in our products has been lead (Pb), which has been removed from all designs to fulfill the requirement of containing less than 0.1% of lead in any homogeneous material.

KEMET will closely follow any changes in legislation on a global basis and make any necessary changes to its products whenever needed.

Some customer segments including medical, defense and automotive electronics may still require the use of lead in electrode coatings. To clarify the situation and distinguish products, the following symbols are used on the packaging labels for RoHS compliant and Pb-free capacitors.

Because of customer requirements, additional markings such as lead-free (LF) or lead-free wires (LFW) may appear on the packaging label.

Materials & Environment

The selection of materials used by KEMET for the production of capacitors is the result of extensive experience and constant attention to environmental protection. KEMET selects its suppliers according to ISO 9001 standards and carries out statistical analysis on the materials purchased before acceptance. All materials are, to the company's present knowledge, non-toxic and free from cadmium, mercury, chrome and compounds, polychlorine triphenyl (PCB), bromide and chlorine dioxins bromurate chlorurate, CFC and HCFC, and asbestos.

All KEMET power film products are ROHS compliant.

Insulation Resistance

When the capacitor temperature increases, the insulation resistance decreases. This is due to increased electron activity. Low insulation resistance can also be the result of moisture trapped in the windings, caused by a prolonged exposure to excessive humidity.

Dissipation Factor

Dissipation factor is a complex function involved with the inefficiency of the capacitor. The $\tan\delta$ may change up and down with an increased temperature. For more information, please refer to Performance Characteristics.

Sealing

Hermetically Sealed Capacitors

When the temperature increases, the pressure inside the capacitor increases. If the internal pressure is high enough, it can cause a breach in the capacitor which can result in leakage, impregnation, filling fluid or moisture susceptibility.

Resin Encased/Wrap & Fill Capacitors

The resin seals on resin encased and wrap and fill capacitors will withstand short-term exposure to high humidity environments without degradation. Resins and plastic tapes will form a pseudo-impervious barrier to humidity and chemicals. These case materials are somewhat porous and through osmosis can cause contaminants to enter the capacitor. The second area of contaminated absorption is the lead-wire/resin interface. Since resins cannot bond 100% to tinned wires, there can be a path formed up to the lead wire into the capacitor section. Aqueous cleaning of circuit boards can aggravate this condition.

Barometric Pressure

The altitude at which hermetically sealed capacitors are operated controls the voltage rating of the capacitor. As the barometric pressure decreases, the susceptibility to terminal arc-over increases. Non-hermetic capacitors can be affected by internal stresses due to pressure changes. This can be in the form of capacitance changes or dielectric arc-over as well as low insulation resistance. Heat transfer can also be affected by altitude operation. Heat generated in operation cannot be dissipated properly and can result in high RI2 losses and eventual failure.

Radiation

Radiation capabilities of capacitors must be taken into consideration. Electrical degradation in the form of dielectric embitterment can take place causing shorts or opens.

Table 1 – Ratings & Part Number Reference

Cap Value (μF)	VDC	Dimensions (mm)					dV/dt (V/μs)	Ipkr	ESL	ESR	Irms*	Rth	PART NUMBER
										70°C at 10 kHz	70°C at 10 kHz	(HS/Amb)	
		Apk	nH	mΩ	Arms	(°C/W)							
5.6	450	11	20	31.5	27.5	\	10	54	25	13.1	4.5	44	C4AEGBU4560A1WK
10	450	13	25	31.5	27.5	\	10	96	25	8.1	6.5	36	C4AEGBU5100A1XK
12.5	450	14	28	31.5	27.5	\	10	122	26	6.8	7.5	33	C4AEGBU5125A1YK
15	450	19	29	31.5	27.5	\	10	147	26	6	8.5	29	C4AEGBU5150A11K
25	450	22	37	31.5	27.5	\	10	245	28	4.5	11.5	23	C4AEGBU5250A12K
40	450	20	40	42	37.5	10.2	7	262	30	3.5	13.5	20	C4AEGBW5400A3FK
50	450	28	37	42	37.5	10.2	7	332	30	2.8	16	18	C4AEGBW5500A3JK
70	450	30	45	42	37.5	20.3	7	464	30	2.1	20.5	15	C4AEGBW5700A3LK
100	450	30	45	57.5	52.5	20.3	4	442	35	3	19	12	C4AEGBW6100A3MK
130	450	35	50	57.5	52.5	20.3	4	581	35	2.4	23	10	C4AEGBW6130A3NK
3.3	600	11	20	31.5	27.5	\	13	41	25	17	4	44	C4AEHBU4330A1WJ
5.6	600	13	25	31.5	27.5	\	13	71	25	10.7	6	36	C4AEHBU4560A1XJ
7	600	14	28	31.5	27.5	\	13	88	26	9	7	33	C4AEHBU4700A1YJ
10	600	19	29	31.5	27.5	\	13	127	26	6.8	8.5	29	C4AEHBU5100A11J
15	600	22	37	31.5	27.5	\	13	190	28	5.3	10.5	23	C4AEHBU5150A12J
20	600	20	40	42	37.5	10.2	9	172	30	5.3	11	20	C4AEHBW5200A3FJ
30	600	28	37	42	37.5	10.2	9	255	30	3.6	14	18	C4AEHBW5300A3JJ
40	600	30	45	42	37.5	20.3	9	344	30	2.8	18	15	C4AEHBW5400A3LJ
55	600	30	45	57.5	52.5	20.3	6	319	35	4.1	16.5	12	C4AEHBW5550A3MJ
75	600	35	50	57.5	52.5	20.3	6	435	35	3.1	20.5	10	C4AEHBW5750A3NJ
2.7	700	11	20	31.5	27.5	\	19	51	25	18.3	4	44	C4AEJBU4270A1WJ
4	700	13	25	31.5	27.5	\	19	77	25	12.9	5.5	36	C4AEJBU4400A1XJ
5	700	14	28	31.5	27.5	\	19	96	26	10.7	6	33	C4AEJBU4500A1YJ
8	700	19	29	31.5	27.5	\	19	154	26	7.3	8	29	C4AEJBU4800A11J
12.5	700	22	37	31.5	27.5	\	19	241	28	5.5	10	23	C4AEJBU5125A12J
15	700	20	40	42	37.5	5.1	13	196	30	6.2	10	20	C4AEJBW5150A3FJ
15	700	20	40	42	37.5	10.2	13	196	30	6.2	10	20	C4AEJBW5150B3FJ
20	700	28	37	42	37.5	10.2	13	262	30	4.7	12.5	18	C4AEJBW5200A3JJ
30	700	30	45	42	37.5	20.3	13	389	30	3.2	16.5	15	C4AEJBW5300A3LJ
45	700	30	45	57.5	52.5	20.3	9	389	35	4.4	16	12	C4AEJBW5450A3MJ
55	700	35	50	57.5	52.5	20.3	9	485	35	3.6	19	10	C4AEJBW5550A3NJ
60	700	35	50	57.5	52.5	20.3	9	530	35	3.4	19.5	10	C4AEJBW5600A3NJ
1.5	900	11	20	31.5	27.5	\	24	36	25	26.3	3.5	44	C4AEQBU4150A1WJ
2.7	900	13	25	31.5	27.5	\	24	65	25	15.3	5	36	C4AEQBU4270A1XJ
3.3	900	14	28	31.5	27.5	\	24	79	26	12.9	5.5	33	C4AEQBU4330A1YJ
5	900	19	29	31.5	27.5	\	24	120	26	9.1	7	29	C4AEQBU4500A11J
8	900	22	37	31.5	27.5	\	24	193	28	6.6	9.5	23	C4AEQBU4800A12J
12	900	20	40	42	37.5	10.2	16	190	30	6.3	10	20	C4AEQBW5120A3FJ
14	900	28	37	42	37.5	10.2	16	229	30	5.4	11.5	18	C4AEQBW5140A3JJ
20	900	30	45	42	37.5	20.3	16	321	30	3.9	15	15	C4AEQBW5200A3LJ
30	900	30	45	57.5	52.5	20.3	11	324	35	5.2	15	12	C4AEQBW5300A3MJ
40	900	35	50	57.5	52.5	20.3	11	428	35	4	18	10	C4AEQBW5400A3NJ
1	1100	11	20	31.5	27.5	\	28	28	25	33.1	3	44	C4AEQBU4100A1WJ
1.8	1100	13	25	31.5	27.5	\	29	52	25	19.1	4.5	36	C4AEQBU4180A1XJ
2.2	1100	14	28	31.5	27.5	\	29	63	26	16	5	33	C4AEQBU4220A1YJ
3.3	1100	19	29	31.5	27.5	\	29	95	26	11.2	6.5	29	C4AEQBU4330A11J
5	1100	22	37	31.5	27.5	\	29	145	28	8.2	8.5	23	C4AEQBU4500A12J
8	1100	20	40	42	37.5	10.2	20	157	30	7.9	9	20	C4AEQBW4800A3FJ
10	1100	28	37	42	37.5	10.2	20	196	30	6.3	11	18	C4AEQBW5100A3JJ
12	1100	30	45	42	37.5	20.3	20	235	30	5.3	13	15	C4AEQBW5120A3LJ
20	1100	30	45	57.5	52.5	20.3	13	262	35	6.5	13	12	C4AEQBW5200A3MJ
25	1100	35	50	57.5	52.5	20.3	13	331	35	5.2	16	10	C4AEQBW5250A3NJ
27	1100	35	50	57.5	52.5	20.3	13	354	35	4.9	16.5	10	C4AEQBW5270A3NJ
Cap Value (μF)	VDC	B	H	L	P	P1	dV/dt (V/μs)	Ipkr	ESL	ESR	Irms	Rth	Part Number

(*) Current value that leads to a ΔT of ~ 15°C in the Hot spot → T_{HS} = T_{AMB} + ΔT = 70°C + 15°C = 85°C

For Packaging quantities not listed contact KEMET

Soldering Process

The implementation of the RoHS directive has resulted in the selection of SnAgCu (SAC) alloys or SnCu alloys as primary solder. This has increased the liquidus temperature from that of 183°C for SnPb eutectic alloy to 217 – 221°C for the new alloys. As a result, the heat stress to the components, even in wave soldering, has increased considerably due to higher pre-heat and wave temperatures. Polypropylene capacitors are especially sensitive to heat (the melting point of polypropylene is 160 – 170°C). Wave soldering can be destructive, especially for mechanically small polypropylene capacitors (with lead spacing of 5 mm to 15 mm), and great care has to be taken during soldering. The recommended solder profiles from KEMET should be used. Please consult KEMET with any questions. In general, the wave soldering curve from IEC Publication 61760-1 edition 2 serves as a solid guideline for successful soldering. Please see Figure 1.

Reflow soldering is not recommended for through-hole film capacitors. Exposing capacitors to a soldering profile in excess of the above the recommended limits may result in degradation or permanent damage to the capacitors.

Do not place the polypropylene capacitor through an adhesive curing oven to cure resin for surface mount components. Insert through-hole parts after the curing of surface mount parts. Consult KEMET to discuss the actual temperature profile in the oven, if through-hole components must pass through the adhesive curing process. A maximum two soldering cycles is recommended. Please allow time for the capacitor surface temperature to return to a normal temperature before the second soldering cycle.

Manual Soldering Recommendations

The following is the recommendation for manual soldering with a soldering iron.

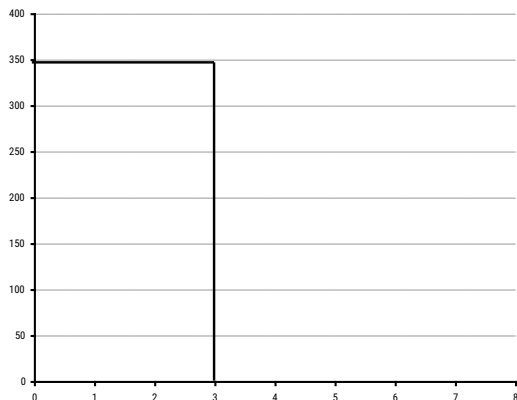

The soldering iron tip temperature should be set at 350°C (+10°C) maximum with the soldering duration not to exceed more than 3 seconds.

Wave Soldering Recommendations

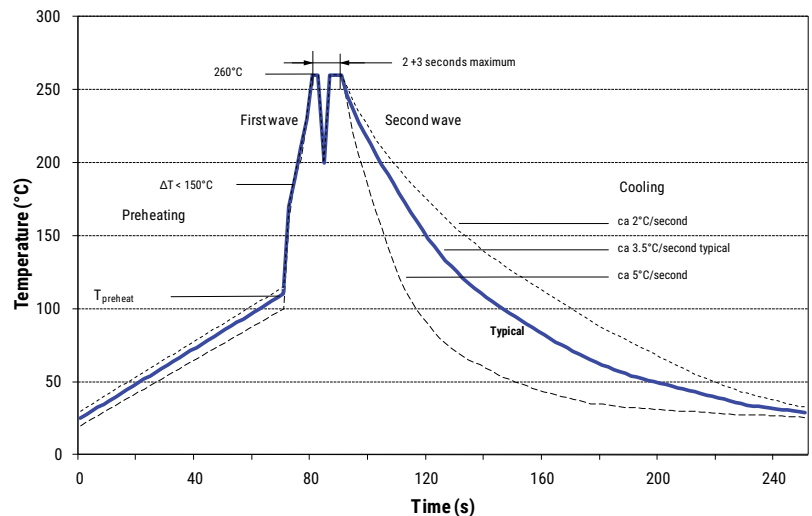

Soldering Process cont'd

Wave Soldering Recommendations cont'd

1. The table indicates the maximum set-up temperature of the soldering process

Figure 1

Dielectric Film Material	Maximum Preheat Temperature			Maximum Peak Soldering Temperature	
	Capacitor Pitch ≤ 10 mm	Capacitor Pitch = 15 mm	Capacitor Pitch > 15 mm	Capacitor Pitch ≤ 15 mm	Capacitor Pitch > 15 mm
Polyester	130°C	130°C	130°C	270°C	270°C
Polypropylene	100°C	110°C	130°C	260°C	270°C
Paper	130°C	130°C	140°C	270°C	270°C
Polyphenylene Sulphide	150°C	150°C	160°C	270°C	270°C

2. The maximum temperature measured inside the capacitor:

Set the temperature so that inside the element the maximum temperature is below the limit:

Dielectric Film Material	Maximum temperature measured inside the element
Polyester	160°C
Polypropylene	110°C
Paper	160°C
Polyphenylene Sulphide	160°C

Temperature monitored inside the capacitor.

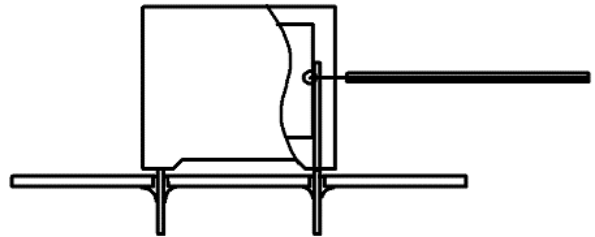

Selective Soldering Recommendations

Selective dip soldering is a variation of reflow soldering. In this method, the printed circuit board with through-hole components to be soldered is preheated and transported over the solder bath as in normal reflow soldering without touching the solder. When the board is over the bath, it is stopped and pre-designed solder pots are lifted from the bath with molten solder only at the places of the selected components, and pressed against the lower surface of the board to solder the components.

The temperature profile for selective soldering is similar to the double wave reflow soldering outlined in this document, however, instead of two baths, there is only one bath with a time from 3 to 10 seconds. In selective soldering, the risk of overheating is greater than in double wave reflow soldering, and great care must be taken so that the parts are not overheated.

Construction

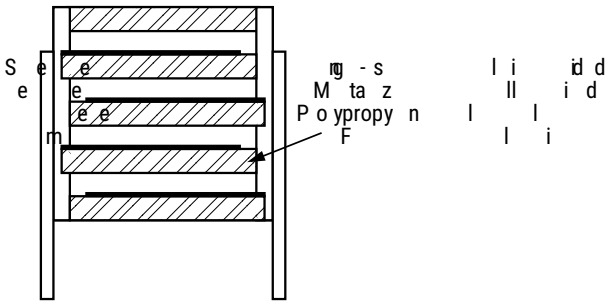
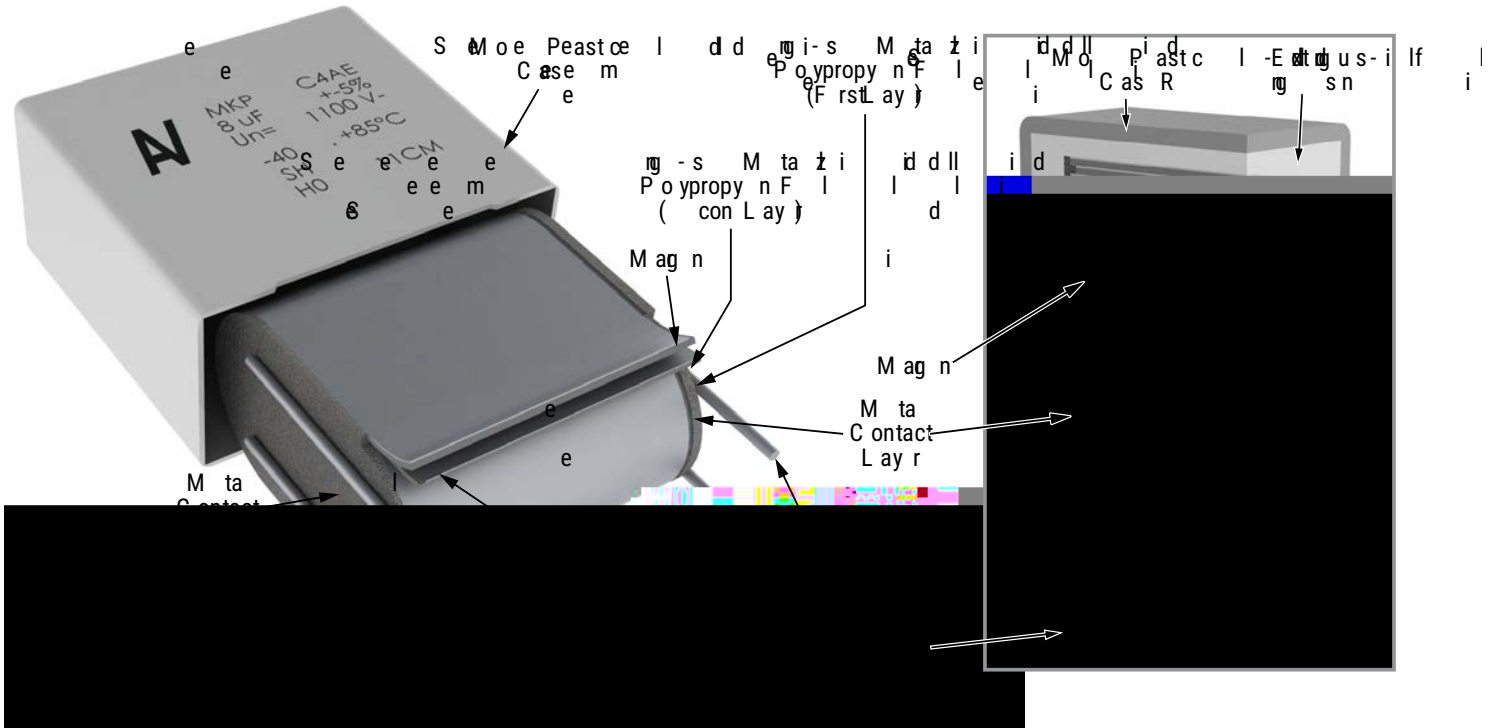

Marking

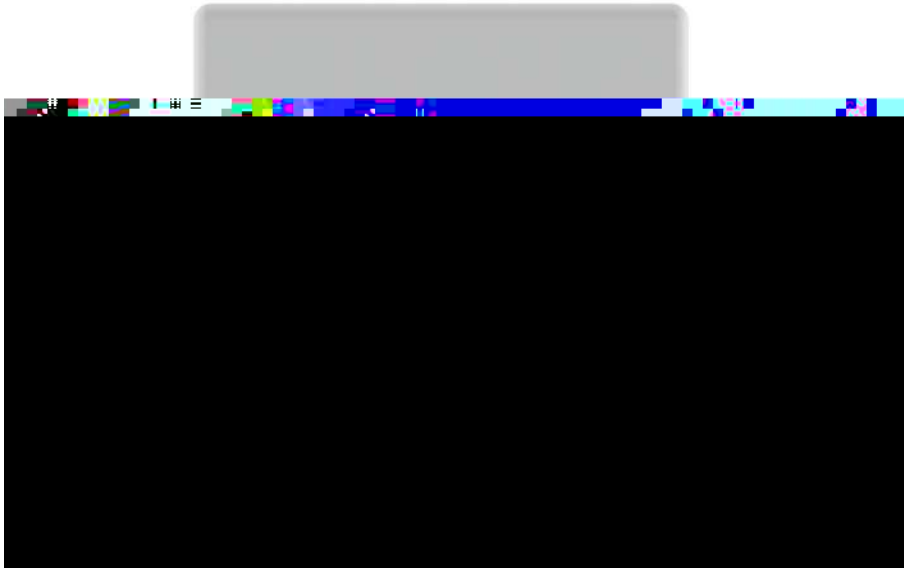

si i i T
 nc i l T
 ld
 i i
 l U

Manufacturing Date Code (IEC-60062)			
Y = Year, Z = Month			
Year	Code	Month	Code
2010	A	January	1
2011	B	February	2
2012	C	March	3
2013	D	April	4
2014	E	May	5
2015	F	June	6
2016	H	July	7
2017	J	August	8
2018	K	September	9
2019	L	October	0
2020	M	November	N
2021	N	December	D
2022	P		
2023	R		
2024	S		
2025	T		
2026	U		
2027	V		
2028	W		
2029	X		
2030	A		

KEMET Electronics Corporation Sales Offices

For a complete list of our global sales offices, please visit www.kemet.com/sales.

Disclaimer

All product specifications, statements, information and data (collectively, the "Information") in this datasheet are subject to change. The customer is responsible for checking and verifying the extent to which the Information contained in this publication is applicable to an order at the time the order is placed.

All Information given herein is believed to be accurate and reliable, but it is presented without guarantee, warranty, or responsibility of any kind, expressed or implied.

Statements of suitability for certain applications are based on KEMET Electronics Corporation's ("KEMET") knowledge of typical operating conditions for such applications, but are not intended to constitute – and KEMET specifically disclaims – any warranty concerning suitability for a specific customer application or use. The Information is intended for use only by customers who have the requisite experience and capability to determine the correct products for their application. Any technical advice inferred from this Information or otherwise provided by KEMET with reference to the use of KEMET's products is given gratis, and KEMET assumes no obligation or liability for the advice given or results obtained.

Although KEMET designs and manufactures its products to the most stringent quality and safety standards, given the current state of the art, isolated component failures may still occur. Accordingly, customer applications which require a high degree of reliability or safety should employ suitable designs or other safeguards (such as installation of protective circuitry or redundancies) in order to ensure that the failure of an electrical component does not result in a risk of personal injury or property damage.

Although all product-related warnings, cautions and notes must be observed, the customer should not assume that all safety measures are indicated or that other measures may not be required.

KEMET is a registered trademark of KEMET Electronics Corporation.