

Control
number

02017-12E-019

Digi-Key

SPECIFICATION	
Manganese dioxide Lithium Battery	
Ordering Code :	CR-1025/H9BN
Model Code :	CR1025

Approved by
Division/Department
Name
Title
Signature/date



ISSUED

Dec,21,2017

PT. Panasonic Gobel Energy Indonesia

Date of Issued : Dec,21,2017

PT. Panasonic Gobel Energy Indonesia

Approved	Checked	Drafted
 K. Panano	 W. An	 Darbingk

Revision history

No.	Date	Revision
1	Dec,21,2017	Issued
2		
3		
4		
5		
6		
7		
8		
9		
10		
11		
12		
13		
14		
15		
16		
17		
18		
19		
20		

1. Applicable range

This specification applies to manganese dioxide lithium batteries which are delivered from Panasonic Corporation AIS Company.

2. Nominal specification

- 2.1. Model code (bare cell) CR1025
- 2.2. Nominal voltage 3V
- 2.3. Nominal capacity 30 mAh
- 2.4. Operation temperature From -30 to 60 °C
(Please consult Panasonic in case continuous high-temperature usage conditions)
- 2.5. Storage Condition (Recommendable) Temperature : 5°C to 35°C, Humidity : 45~85%RH
- 2.6. Mass Refer to drawing 1
- 2.7. Dimension Refer to drawing 1
- 2.8. Battery composition Lithium primary battery composed of cathode from manganese dioxide anode from lithium and electrolyte from organic solvent and lithium salt.
- 2.9. Terminal material Stainless steel, partially Ni and Tin Plating on soldering area.

3. Battery characteristics

Table 1. CR1025 characteristics

	Items	Test method	Temperature		initial	After 1 year in room temperature
1	Open circuit voltage	Voltage between terminals (Min)	20 +/- 2°C		3.1V	3.1V
2	Internal resistance	1kHz sine wave method (Max.)	20 +/- 2°C		80 Ω	-
3	Discharge duration	Continuous discharge (Std.)	20 +/- 2°C	Load : 68k Ω cut offV : 2.0V	710h	695h
		Continuous discharge (Min.)			639h	625h

4. Indication and others

4.1. Items below are indicated on battery or its package

- Model code CR1025
- Nominal voltage 3V
- Plus polarity +
- Manufacturer or its brand : Panasonic
- Production country and Classification Made in Indonesia

(Design of indication can be changed without notice)

4.2. Production date code

4.2.1 Battery assemble date.

Battery assembling date is expressed by two digit code and is stamped at the center of negative case.

First digit: The last digit of dominical year;

Second digit; Month (October=O, November=Y, December=Z)

[Example] : 3Z ⇒ (December 2013)

*Please note that the terminal attached on the negative case possibly cover the date code.

4.2.2. Terminal assembling date

In case of terminals attached battery, terminal assembling date is appeared on the battery surface described by four digit code as hereafter defined.

First digit: The last digit of dominical year;

Second digit: Month (October=O, November=Y, December=Z)

Third digit: Week (1: first week, 2: second week, ..., 6: sixth week)

Forth digit: Day (0: Sun, 1: Mon, 2: Tue, ..., 7: Sat)

[Example] : 3922 ⇒ (Year 2013, Sep, 2nd week, Tue) ⇒ September. 10th 2013.

4.3. UL

This battery is certificate by UL and listed on file number MH12210

4.4 Production Site

PT. Panasonic Gobel Energy Indonesia, Jl.Teuku Umar Km. 44, Cikarang Barat Bekasi, Jawa Barat Indonesia

4.5 RoHS comply

The battery herein complies with EU battery directive (2006/66/EC).

Since the batteries shall comply with EU battery directive (2006/66/EC), RoHS directive does not cover batteries. However, this battery does not use the Six substances restricted by RoHS directive.

Therefore, each content of Six restricted substances is less than the maximum amount regulated by RoHS.

Drawing 1. Dimensions

Ordering code : CR1025

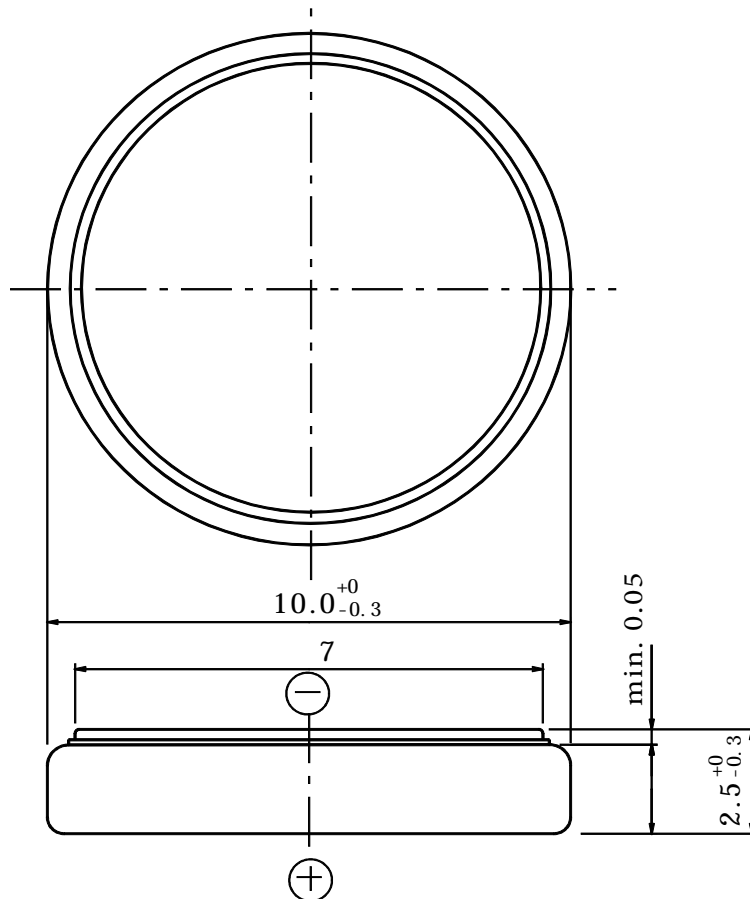

Terminal : Plus terminal material : Nickel plated stainless steel
Minus terminal material : Nickel plated stainless steel

Mass : Approx. 0.7 g

5. Test condition and performance

- 5.1. External dimensions Measure the battery dimensions with caliper described in item 6.3.(1) herein without making short-circuit.
Dimensions shall be confirmed with drawing 1 herein.
- 5.2. Open circuit voltage Measure the open circuit voltage with the voltage meter described in item 6.3.(2) herein after keeping the battery for 2 hours at least in measurement environment. Open circuit voltage shall conform to table 1 herein.
- 5.3 Internal resistance Measure the interenal resistance with the resistance meter described in item 6.3.(3) herein after keeping the battery for 2 hours at least in measurement environment. Internal resistance shall conform to table 1 herein.
- 5.4. Discharge duration Discharge the battery with the load resistance specified in table 1 herein after keeping the battery in measurement environment for 8 hours at least. The discharge duration is determined as an operation time that the operation voltage reaches to the cut off voltage specified in the table 1 herein.
Discharge duration shall conform to table 1 herein.
- 5.5. Anti-leakage Appearance check after 42 cycles of thermal cycle by the condition showing below. Battery shall not have deformation or leakage.
* This test shall be started from high temperature (60°C) position.
* No humidifying to ambient temperature and humidity.

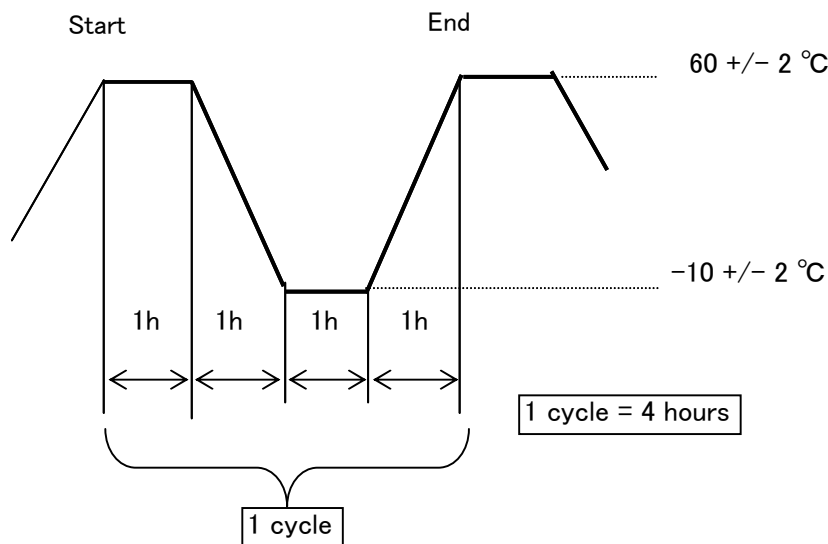

5.6. Storage characteristics

- (1) Open circuit voltage After storage term described on table 1 herein, keep the battery for 4 hours at least in measurement environment, then measure the open circuit voltage with the voltage meter described in item 6.3.(2) herein.
Open circuit voltage shall conform to table 1 herein.
- (2) Internal resistance After storage term described on table 1 herein, keep the battery for 4 hours at least in measurement environment, then measure the internal resistance with the resistance meter described in item 6.3.(3) herein. Internal resistance shall conform to table 1
- (3) Discharge duration After storage term described on table 1 herein, keep the battery for 8 hours at least in measurement environment, then discharge the battery with the load resistance specified in table 1 herein. The discharge duration is determined as an operation time that the operation voltage reaches to the cut off voltage specified in the table 1 herein.
Discharge duration shall conform to values described in table 1 herein.

5.7. Appearance

No deformation, bruise and stain which cause practical interference.

6. Test conditions

- 6.1. Initial test Initial test must be started within 2 months from delivery.
- 6.2. Temperature and humidity Unless otherwise specified, test should be carried out in room temperature (20 +/- 15 °C) and room humidity (65 +/- 20%RH).

6.3. Measuring equipment's

(1) Dimension

Micrometer defined by JIS B7502 or equivalent or more accurate one must be used for dimension measurement.

For one digit decimals tolerance, caliper with 0.05mm accuracy which is defined JIS B7507 or higher accuracy equipment must be used.

(2) Voltage

Voltage meter defined by JIS C1102 class 0.2 or higher, and more than 10Mohm impedance must be used.

(3) Internal resistance

It should be measured by sinusoidal current method (1kHz). Measurement should be finished within 5 seconds.

(As a general rule, Agilent Technologies LCRmeter 4263B or equivalent should be used.)

(4) Load resistance includes all resistance of discharge circuit, and its tolerance shall be less than 0.5%.

(5) Appearance check is observed by visual evaluation.

7. Revision and modification of this specification

Revision and modification must be carried out after the prior mutual agreement.

All accidents or issues caused by any events that are neither defined nor described in this specification, mutual discussion shall take place for the resolution.

8. Important Notes (Warranty)

- 1) The batteries are warranted to conform to the description contained in this specifications for a period of twelve **[12]** months from the ex-factory date and any claim by customer (apparatus manufacturer or distributor) must be made within such period. During that warranty period, if the batteries are proved to become defective, non-defective and conforming batteries will be supplied in due course at sole expense of Panasonic upon Panasonic's own determination that this is apparently caused by negligence of Panasonic.
- 2) Confirm and assure the matching and reliability of batteries on actual set or unit application with customer's responsibility.
- 3) Panasonic shall not warrant or be responsible in any case where customer fails to carry out proper handling, operating, installation, testing, service and checkout of the batteries and/or to follow the instruction, cautions, warnings, notes provided in this specifications, or other Panasonic's reasonable instructions or advise.
- 4) Panasonic will not be held responsible for any issues caused by modifications to the battery taken place after that the battery is delivered to the customer end.
The battery shall not be resoled to any other parties.
- 5) This product specification will be validated assuming that it is accepted when it is not returned within six months from the date of issue.

9. Precautions for use

9.1 Cautions for storage

- Store the battery at a constant temperature of 35 degree C or less in order to prevent deteriorations from heat.
- Keep the battery away from high humidity such as 85% RH or higher in order to prevent dew condensations on the battery that may cause to electrical leakage,
- Keep the battery away from heat sources i.e., boiler, radiator and etc., and from direct sunlight.

9.2 Warning for safety

Following cautions should be taken into consideration in order to use this battery in safe, since the battery contains combustible materials such as Lithium metal and organic electrolyte.

- Do not use except in applicable model or equipment.
- Do not mix fresh and used batteries.
- Do not mix different types (chemistries) of batteries.
- Do not short circuit.
- Do not charge.
- If multiple batteries are kept in contact with each other. The (+) and (-) terminals may short-circuit, and/or the charging possibly happen by other adjacent batteries, which may cause of shorten service life, significant damages and catching fire.
- Do not dispose into fire.
- Do not heat up higher than 100 .
- Do not solder direct to battery.
- Do not disassemble.
- Do not soak in water.
- Do not deform.
- Do not apply inadequacy modifications or remodeling on the batteries.
- Insert the batteries in the correct polarity position.

Warning for prevention of ingestion accident

- Small-sized batteries can easily be swallowed. They must be kept out of the reach of small children.
- Also, in the design of equipment using batteries, the care should be taken to ensure that batteries are NOT easy removable for children.

9.3 Caution for better usage

- Due to this battery is originally designed for welding terminals for soldering on the circuit board, both of plus and minus terminals of the battery are made of stainless steel without any surface treatments or plating. That could be a cause of low conductivity problems between battery surface and terminals from application if this battery is used by bare cell without welded terminals. Therefore, if using this battery by bare cell, the customer shall take responsibility of conductivity between the battery surface and terminals from applications.
- Before inserting batteries, check the terminal contact surfaces on both the equipment and the batteries are clean, and also check that they are not deformed. If the contact surfaces are dirty, clean up and dry them thoroughly before inserting batteries.
- Even if batteries of the same size or same shape, they may differ in type or grade. When replacing batteries, confirm that they are correct type by checking the identification symbol (designated by I.E.C. standards) which is marked on the battery and its packages.
- Lithium primary batteries continuously indicate high voltage even toward the end of their service life. As such, they may be mistakenly judged as yet being strong. In case of multiple batteries are used in an application or equipment, all batteries should be replaced at the same time when the one of those batteries shows it has totally consumed even other batteries seems still operating, since the remaining capacity in other batteries must be also quite little at the time.
- When multiple batteries are used in series in applications or equipments, it may occur that the one battery has a polarity inversion at the end of operation life. That behavior happen when the battery had consumed its capacity earlier than other batteries. Therefore, that is not failure of battery.

- When the Lithium battery has short-circuit, even slightly. A certain amount of time is required for recovering its voltage completely. If the electrical characteristics of the battery are measured at a time before a sufficient time has passed, it may indicate unstable values due to the battery was in recovering mode.
- If the battery touch with any antistatic conductive materials include packing bags, trays, mats, sheets, films and resin cases, sheets, for example, have a resistance of 10^3 to 10^6 , it may cause of short-circuit since both the positive and the negative terminal of the battery may contact with those materials. In order to prevent short circuit, special attention may apply when handle batteries or battery attached PCB in close to those materials.

Notice for equipment design

- Keep batteries away from heat source or flame, and water.
- Please contact us in case of using multiple batteries.

10. Precautions for Lithium Battery Soldering

10.1 Never attempt reflows solder:

- Reflow soldering should never be used for a lithium battery as it heats the battery body to a high temperature, possibly causing electrolyte leakage, performance degradation, or in the worst case, explosion or combustion.

10.2 flow soldering (dip soldering)

Soldering with a dip-soldering bath can be used but do not allow the temperature of the battery bodies to exceed 85 . It is important to note, depending on the temperature conditions inside the dipping device, that the battery body temperature may rise after dipping due to the residual heat retained. When a post-dipping temperature rise is observed, review the temperature conditions and consider a dipping time reduction or a way of forcibly cooling the batteries after dipping.

Basic conditions

Solder dipping bath temperature : Not exceed 260

Dipping duration : Within 5 sec.

Number of dipping : Within 2 times

10.3 Soldering iron

Basic condition

Temperature of iron : 350

Time of soldering : within 5seconds

- Take care to keep the soldering iron from direct contact with the battery body.
- Limit soldering iron temperature to approx. 350 , and finish soldering within5 seconds.

Battery temperature have to be kept below 85 .

Warning: Do not solder directly on battery.

If the battery is heated beyond a certain threshold, it may damage the gasket or separator, causing electrolyte leakage or performance degradation. In the worst case, explosion or combustion may result from excessive inner pressure.

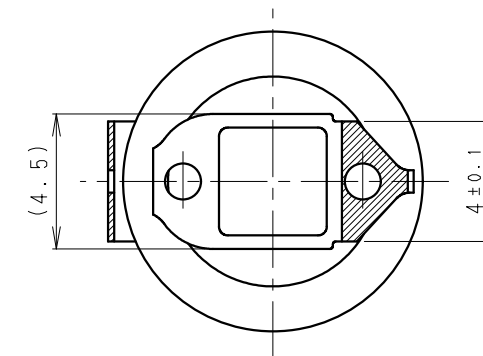
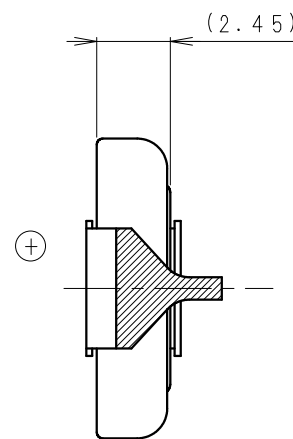
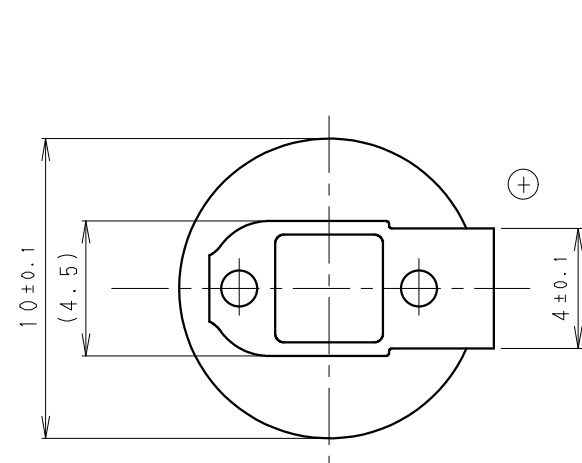

DATE CODE INDICATION
ON THIS SIDE [ロット表示面]

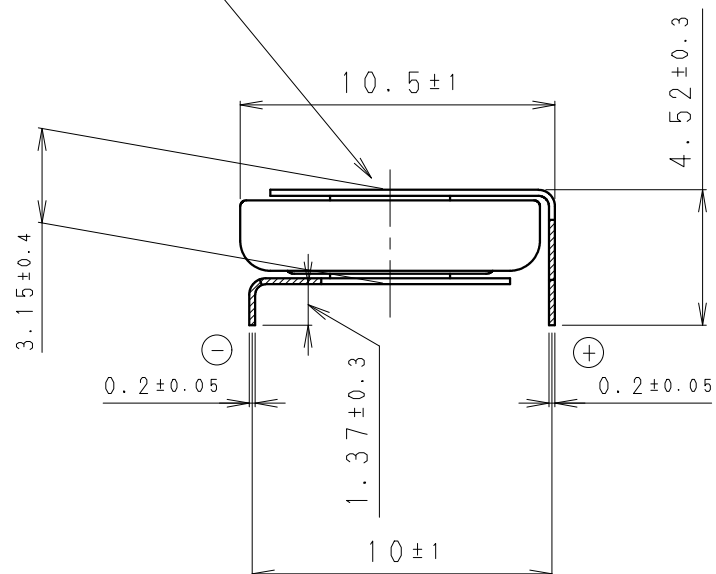
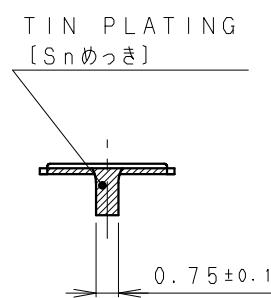

TIN PLATING
[Snめっき]

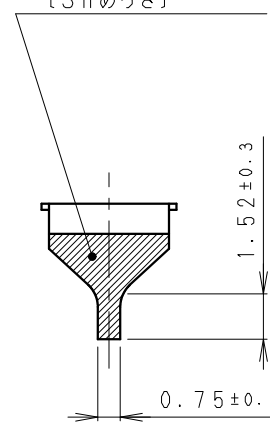

NOTE [注記]

1. NOMINAL VOLTAGE: 3V [公称電圧: 3V]
2. TAB WELDING STRENGTH OVER 19.6N [端子溶接強度: 19.6N以上]
3. TAB MATERIAL: STAINLESS STEEL WITH TIN PLATING [端子材料: 基材 ステンレス/表面 部分Snめっき]
4. (): REFERENCE DIMENSION AND ANGLE [() 寸法、角度は参考値]

CUSTOMER	
SIGNATURE	
NAME	
POSITION	
DATE	

PRODUCT NO.	CR-1025/H9BN	SCALE	4:1
		DRAWING NO.	GGHB1N
		REV.	0
		UNIT: mm	

Packaging Specification

Drawing Number

232-C16-148G_B

Lithium battery with tab

Tray for 40pcs.×Shrink Packing for 240pcs.×Outer Carton for 480pcs.

1-Product

Refer to the product drawing

2-Tray for 40pcs.

*The battery shape is different by product number

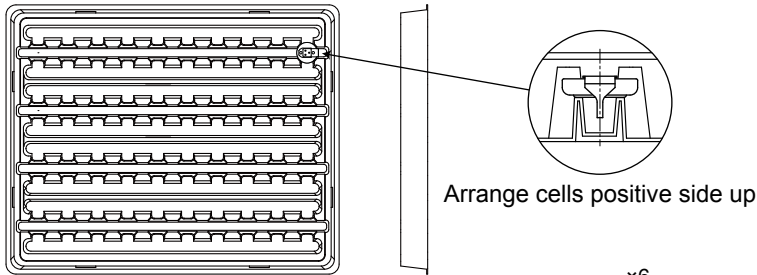

3-Shrink Packing for 240pcs.

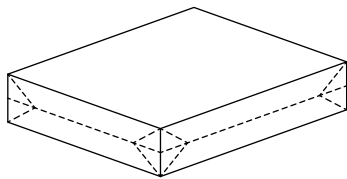

×6

Empty tray as lid 1pc.

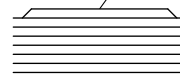

4-Outer Carton for 480pcs.

×2

Alignment

Product No.
BRAND
240pcs.×2
xxxx

Date of tab welding
(4-digit)

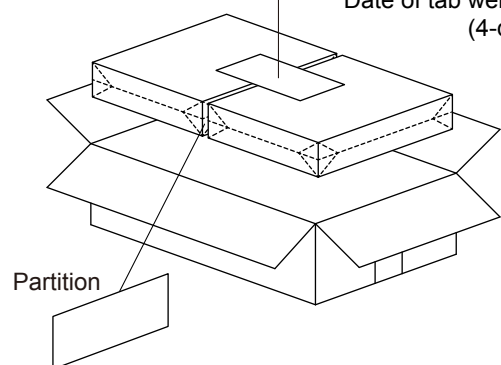
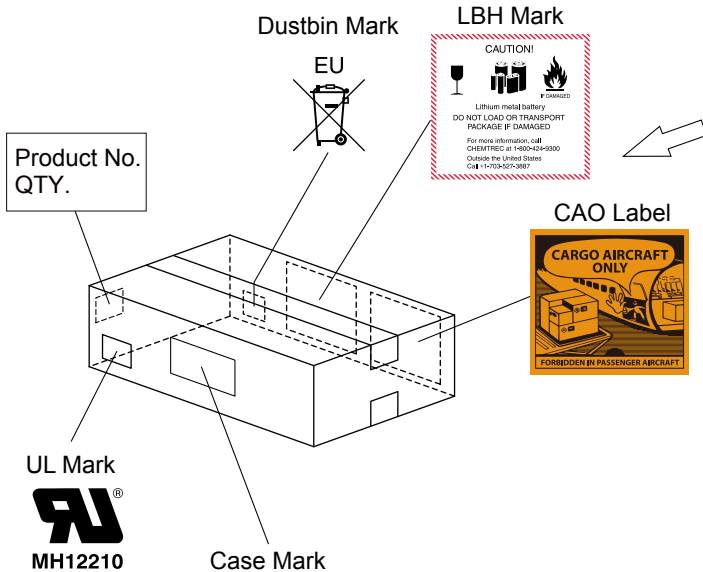

※ Fill the space with the buffer materials

Packing List

Dimension : 188×296×132mm
M3 : 0.0074m³
Net : 0.37kg
Gross : 0.83kg

Cautions on Battery Handling and Usage

Improper battery Usage may result in deteriorated battery performance. Please read and follow the precautions below.

1. Short-circuit

Shorting the terminals will increase voltage recovery time and make circuit inspection more difficult. Hot soldering may result in decreased electrical capacity.

Accordingly, lithium batteries should only be soldered with the dip solder method.

Use only high input resistance ($10M\Omega$) voltage testers to measure battery capacity.

2. Charging

Lithium batteries are not rechargeable. Accordingly, they should be protected with a backflow prevention diode having extremely low current leakage.

Charged electricity should be less than 3% of nominal capacity at a maximum $1\ \mu A$, when it is inevitable.

3. Soldering

Soldering should be completed within 3 to 5 seconds.

Maximum soldering conditions are shown below.

<u>Tip temperature</u>	<u>Solder time</u>
350°C(662°F)	max. 5 sec.
260°C(500°F)	max. 10 sec.

When soldering with the dip solder method, the terminal should be placed in a 260°C solder bath for 3 to 5 sec. with the battery shell protected by a thermal shield, circuit board, or similar medium.

4. Cleaning

Special care in selecting solvent type and drying conditions is required for cleaning with organic solvents.

Under no conditions should chloride-based solvents be used.

5. Mounting

Care should be taken to prevent any decrease in insulation between poles due to dust or other foreign matter.

Lithium batteries should not be mounted near high heat sources or used

for extended periods in high temperatures.

Do not set printed circuit boards and similar products on a conductive plate after battery mounting as this may cause the battery to short.

Contact between batteries and conductive mats used for static prevention (used to protect printed circuit boards, during shipping) after battery mounting may complete a circuit which could drain the battery.

Be sure to sufficiently insulate the battery.

6. Battery handling

DO NOT: invert polarities, disassemble, burn, directly solder, or spot weld batteries.

Applying excessive pressure to the battery terminals may cause them to bend or break off.

Wear a rubber or cloth fingerstall when handling the batteries to keep them clean.

Room temperatures and humidity should be used for long term storage.

Be sure to prevent shorting of battery terminals during storage.

7. UL standards

Be sure to observe the specifications given for each product in the catalogue when the product with which they will be used must conform to UL standards.

8. Others

Please contact your Panasonic distributor or our Panasonic's office should there be any questions concerning the use or specifications of Panasonic batteries.

Battery Safety Practices

Avoiding hazards in lithium battery handling



Warning

Mishandling batteries can cause battery leakage, heat generation, rupture, ignition etc., that can lead to possible fire or injury.

Both of coin type and cylinder type of lithium batteries contain flammable materials such as lithium, organic solvent and other chemical ingredients. Improper handling of lithium batteries may result in heat generation, fire or explosion, with a risk of personal injury or damage. To prevent these accidents in battery handling, be sure to observe the following precautions.

1. Do not Short circuit

Direct connection of plus(+) and minus(-) poles may result in leakage, heat generation, explosion and/or fire.

Do not store and/or carry batteries with metallic product such as necklace. (Refer fig.1)

Fig. 1 Short circuit

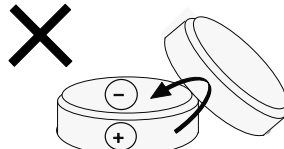

Fig. 2 stacked & jumble batteries



2. Do not stack and/or jumble batteries

Stacked and/or jumbled batteries may cause short circuit and/or forced discharge by the contact of other batteries. This may result in leakage, heat generation, explosion and/or fire.

Especially, a connection with the 006P(9V) type batteries may have a high risk of leakage, heat generation, explosion and/or fire. (Refer fig.2 & 3)

3. Do not make forced discharge batteries

Forced discharge by external power source, the battery voltage goes to negative and this cause gas generation in inside of the battery. This may result in leakage, heat generation, explosion and/or fire. (Refer fig.3)

* In your disposal and/or storage of the batteries, please isolate plus and minus poles by adhesive tape. A connection with other metals and/or batteries may result in leakage, heat generation, explosion and/or fire.

* When using the stored battery, please remove the tape perfectly to avoid high contact resistance problem. (Refer fig.4)

4. Do not dispose of batteries in fire

Disposal of batteries in fire is extremely dangerous with a risk of explosion and violent flaring.

5. Do not heat batteries

Heating batteries above 100°C (212°F) may damage the resin in crimping, separator and other parts, causing electrolyte leak, internal short circuit, fire and explosion.

6. Do not solder directly onto batteries

Direct soldering onto batteries may damage the resin in crimping, separator and other parts, causing electrolyte leak, internal short circuit, fire and explosion.

7. Do not charge batteries

Charging of primary batteries may result internal gas generation, causing electrolyte leak, battery swelling, fire and explosion.

8. Do not disassemble batteries

Disassembly batteries may cause gas generation that may irritate your throat. Lithium may also react with moisture to generate heat and fire.

9. Do not deform batteries

Applying extreme pressure to batteries may cause deformation of the crimping and internal short circuit, causing electrolyte leak, battery swelling, fire and explosion.

10. Do not mix different type batteries

For some applications, mixing of different type batteries, or new and old batteries, can cause over discharge due to differences in voltage and discharge capacities. This may lead to the risk of swelling and/or explosion.

11. Do not insert batteries with opposite polarity

For some applications, battery insertion with opposite polarity (reverse insertion of plus and minus) may result in leakage, heat generation, explosion and/or fire.

Please ensure the above precautions are strictly observed by related divisions including production departments, sales departments and external subcontractors. For additional details and information, please contact our sales representatives.

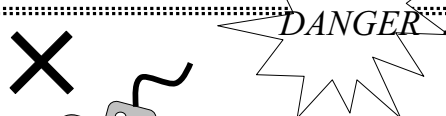
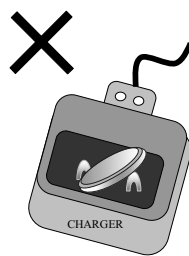

Fig. 3
Examples of forced discharge



Connection with battery charger

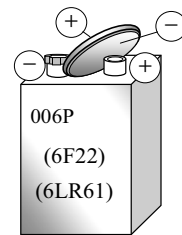
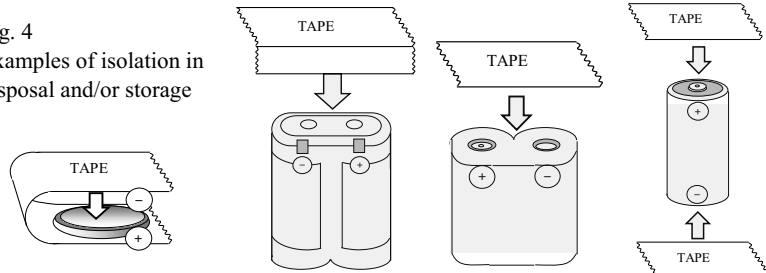

Fig. 4
Examples of isolation in disposal and/or storage



Beware of Antistatic Conductive Materials

Whenever terminal-mounted backup batteries or coin-type lithium batteries contact conductive materials, they discharge. Measures to protect semiconductor parts from static damage have been implemented in plants that use such ICs and LSIs. A number of protective materials are presently being used, and all contain blends of carbon, aluminum and other metals that make them conduct.

Antistatic conductive materials include packing bags, trays, mats, sheets, film and resin cases. Sheets, for example, have a resistance of 10^3 to $10^6 \Omega$, which means that when they contact the positive and negative terminals of a battery, they will discharge the battery.

In a lithium battery, a current flow of several μA to several mA reduces its voltage and electrical capacity. We recommend constant attention when using batteries around protective materials.

Examples

A terminal-mounted battery with its terminals inserted into a conductive mat is completely discharged after several days.

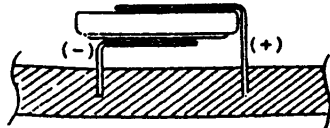

Conductive mat

A PCB-mounted battery is completely discharged by contact with the conductive resin case.

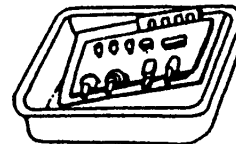

Conductive resin case

PCB-mounted batteries are discharged by contact with spacers and conductive rubber sheets.

Spacer

Conductive rubber sheet

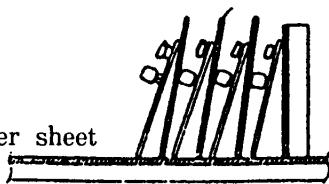

Batteries left on a work bench with positive and negative terminals in direct contact with the grounded rubber sheet cover are completely discharged.

Ground wire

Conductive sheet

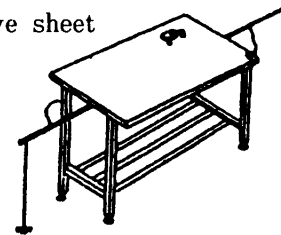

For more information, please make contact with your local dealer.

Preventing Accidental Memory Erasure

Coin-type Lithium batteries are widely used for memory backup purposes. However, there have been an increasing number of cases of accidental memory erasure due to inadequate battery contact.

To prevent unexpected memory erasure, consider the following tips for proper use.

< Long-term Continuous Battery Use >

- Use a battery with solderable tab terminals, so that the battery can be permanently soldered to terminal pads on the circuit board (Fig. 1).
- If the battery requires periodic replacement, use a battery holder (Fig. 2) or a battery with in-line lead connectors (Fig. 3).

The battery holder can be adjusted to suit any Panasonic lithium battery (Fig. 2).

< Batteries Requiring Short-Term Periodic Replacement --- Using batteries without solderable tab terminals or lead connectors >

- Use gold- or nickel-plated steel or stainless-steel strips for battery terminal contacts. Terminals made of gold-plated phosphor bronze will ensure contact with long-term stability.
- Y-shaped terminals (double contacts) for both the anode and cathode offer very stable contact (Fig. 4).

Each contact on the Y-shaped terminals requires a minimum contact pressure of 2-10N {approximately 200~1000gf} (Fig. 5).

- To guard against momentary contact failures of a few milliseconds in duration, use the tantalum capacitor-diode-resistor circuit shown in Fig. 6.
- * Do not touch the contact surfaces of the battery with bare hands, as this will increase the contact resistance and impair proper contact.

Figures 1 through 6 show examples of how to ensure proper battery contact.

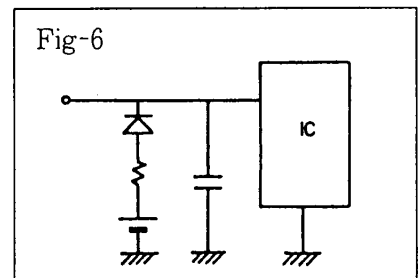
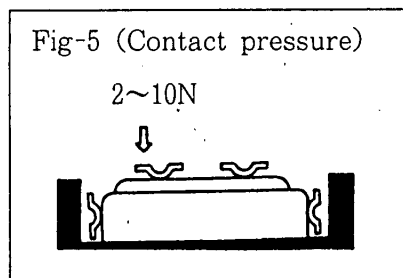
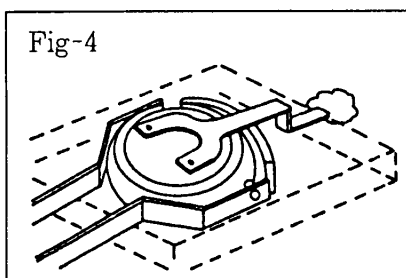
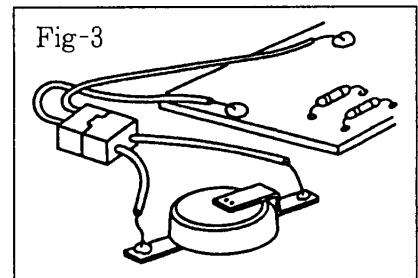
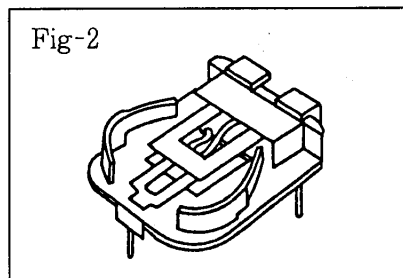
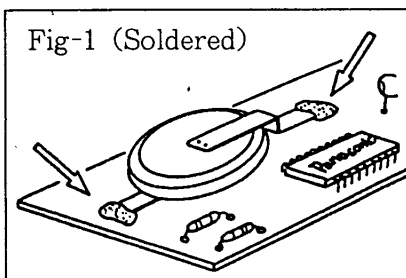

For more information, please make contact with your local dealer.

Precautions for Lithium Battery Soldering

When a lithium battery (with soldering tabs) is soldered to a PC board, the heat from soldering may damage the sealing gasket, possibly resulting in electrolyte leakage. Please observe the following precautions:

Precautions for Soldering

1. Never attempt reflow solder:

Reflow soldering should never be used for a lithium battery as it heats the battery body to a high temperature, possibly causing electrolyte leakage, performance degradation, or in the worst case, explosion or combustion.

2. Tab terminal soldering with a soldering iron:

Take care to keep the soldering iron from direct contact with the battery body. Limit soldering iron temperature to approx. 350°C, and finish soldering within 5 seconds.

3. Soldering in an automatic dip bath:

- While soldering in an automatic dip bath is allowable, the battery temperature should be limited to below 85°C throughout and after the dip process.
- Note that the battery temperature may exceed 85°C after the dip process due to residual heat within the dip machine.
- If the battery temperature exceeds 85°C, review the dip soldering environment and/ or dip time, or use forced cooling after the dip process.
- The basic limits on dip soldering are as follows:
 - Dip bath temperature = 260°C or below
 - Dip duration = 5 sec. or less
 - No. of dip cycles = 2 or less
 - (If the battery temperature is expected to exceed 85°C, please consult us.)

Other Precautions

- Never attempt direct soldering on the battery body.
- Never attempt to weld tab terminals or any other object to the battery body. If welding is needed, please consult us.

The battery's gasket and separator use plastics with low softening temperatures. Also, an organic solvent with a low boiling point is used for the electrolyte.

If the battery is heated beyond a certain threshold, it may damage the gasket or separator, causing electrolyte leakage or performance degradation. In the worst case, explosion or combustion may result from excessive inner pressure.

For more information, please contact the sales division in charge.

**Precautions for Proper Use of Coin Type
Lithium Batteries**

Be careful not to allow heat from the soldering iron or the hot air used for solder melting to damage the batteries during the removal of mounted electronic components.

Case Study and Explanation:

The following problem sometimes occurs: externally applied heat melts and deforms the gasket of a coin type lithium battery mounted on a printed circuit board. Due to deformation of the gasket, the battery gasket seal gradually weakens, and the electrolyte leaks out or evaporates through the gap between the gasket and the metal cap or between the gasket and the positive terminal case. As a result, the electrical characteristics of the battery degrade.

A plastic material with a low softening temperature is used for the gaskets and separators of the batteries. If a battery is heated to a high temperature the gasket or separator will sustain damage causing leakage or degradation of the battery characteristics.

[Overview of the problem]

It is occasionally necessary to remove (desolder) electronic components, including batteries that have already been soldered onto a printed circuit board.

Hot Air Tools are a commonly used method for melting solder joints to remove electronic components with multiple leads. However, the hot air may heat the batteries adjacent to the electronic components being removed. In addition, when removing a mounted battery using a soldering iron and resoldering it, ensure that the heat applied by the soldering iron does not damage the battery.

<Problem examples>**Example 1: Electrolyte leakage at a user's site**

Cause: When replacing or repairing electronic components with multiple leads, such as ICs and connectors, on a printed circuit board rejected from the production line, hot air of about 260°C was applied to melt the solder joints. During the application of hot air an adjacent battery was also exposed to the heat, its gasket melted and became deformed causing the battery's seal integrity to degrade gradually leading to electrolyte leakage.

Example 2: Memory erasure occurred at a user's site.

Cause: When a battery with terminals was mounted onto a printed circuit board, the soldering iron heated the battery to an extremely high temperature. The temperature of the battery itself abnormally increased and the battery gasket melted and became deformed. Afterwards, the electrolyte gradually evaporated from the battery due to the decreased integrity of the seal, degrading the battery's characteristics.

[Countermeasures]

- (1) When removing electronic components from a printed circuit board using hot air, be sure to remove any batteries first.
 - Regarding batteries with terminals, it is important to remove them quickly to prevent the soldering iron from transferring the extreme heat to the batteries.
 - If a battery is set in a holder, first remove the battery from the holder.
Remove the other electronic components only after following the above procedures.
- (2) When only using a soldering iron without hot air, remove the electronic components quickly so as not to allow excessive heat from the soldering iron to transfer to the batteries.

Note: Due to the potential safety hazard, never solder directly to the body of the battery. Solder to the terminals only.

Panasonic also offers heat-resistant BR type coin cells for use at high temperatures. Please contact us for more information.

Please thoroughly notify all relevant parties/departments of these precautions, including manufacturing and sales departments or subcontractors.