

Si4030/31/32 ISM TRANSMITTER

Features

- Frequency range
 - 240–930 MHz (Si4031/32)
 - 900–960 MHz (Si4030)
- Output Power Range
 - +1 to +20 dBm (Si4032)
 - –8 to +13 dBm (Si4030/31)
- Low Power Consumption
 - Si4032
85 mA @ +20 dBm
 - Si4030/31
30 mA @ +13 dBm
- Data Rate = 0.123 to 256 kbps
- FSK, GFSK, and OOK modulation
- Power Supply = 1.8 to 3.6 V
- Ultra low power shutdown mode
- Wake-up timer
- Integrated 32 kHz RC or 32 kHz XTAL
- Integrated voltage regulators
- Configurable packet handler
- TX 64 byte FIFO
- Low battery detector
- Temperature sensor and 8-bit ADC
- –40 to +85 °C temperature range
- Integrated voltage regulators
- Frequency hopping capability
- On-chip crystal tuning
- 20-Pin QFN package
- Low BOM
- Power-on-reset (POR)

Applications

- Remote control
- Home security & alarm
- Telemetry
- Personal data logging
- Toy control
- Wireless PC peripherals
- Remote meter reading
- Remote keyless entry
- Home automation
- Industrial control
- Sensor networks
- Health monitors

Description

Silicon Laboratories' Si4030/31/32 devices are highly integrated, single-chip wireless ISM transmitters. The high-performance EZRadioPRO[®] family includes a complete line of transmitters, receivers, and transceivers allowing the RF system designer to choose the optimal wireless part for their application.

The Si4030/31/32 offers advanced radio features including continuous frequency coverage from 240–960 MHz with adjustable power output levels of –8 to +13 dBm on the Si4030/31 and +1 to +20 dBm on the Si4032. Power adjustments are made in 3 dB steps. The Si4030/31/32's high level of integration offers reduced BOM cost while simplifying the overall system design. The Si4032's Industry leading +20 dBm output power ensures extended range and improved link performance.

Additional system features such as an automatic wake-up timer, low battery detector, 64 byte TX FIFO, and automatic packet handling reduce overall current consumption and allow the use of lower-cost system MCUs. An integrated temperature sensor, general purpose ADC, power-on-reset (POR), and GPIOs further reduce overall system cost and size.

The direct digital transmit modulation and automatic PA power ramping ensure precise transmit modulation and reduced spectral spreading ensuring compliance with global regulations including FCC, ETSI, and ARIB regulations.

An easy-to-use calculator is provided to quickly configure the radio settings, simplifying customer's system design and reducing time to market.

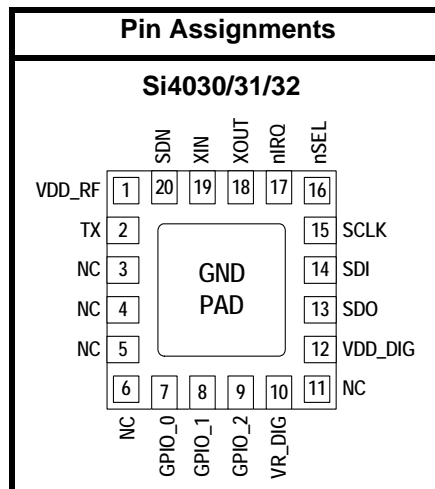

Patents pending

Si4030/31/32-B1

Functional Block Diagram



TABLE OF CONTENTS

<u>Section</u>	<u>Page</u>
1. Electrical Specifications	7
1.1. Definition of Test Conditions	13
2. Functional Description	14
2.1. Operating Modes	14
3. Controller Interface	15
3.1. Serial Peripheral Interface (SPI)	15
3.2. Operating Mode Control	17
3.3. Interrupts	20
3.4. System Timing	21
3.5. Frequency Control	22
4. Modulation Options	27
4.1. Modulation Type	27
4.2. Modulation Data Source	28
5. Internal Functional Blocks	31
5.1. Synthesizer	31
5.2. Power Amplifier	31
5.3. Crystal Oscillator	33
5.4. Regulators	33
6. Data Handling and Packet Handler	34
6.1. TX FIFO	34
6.2. Packet Configuration	35
6.3. Packet Handler TX Mode	35
6.4. Data Whitening, Manchester Encoding, and CRC	37
6.5. Synchronization Word Configuration	37
6.6. TX Retransmission and Auto TX	38
7. Auxiliary Functions	39
7.1. Smart Reset	39
7.2. Microcontroller Clock	40
7.3. General Purpose ADC	41
7.4. Temperature Sensor	42
7.5. Low Battery Detector	44
7.6. Wake-Up Timer	45
7.7. GPIO Configuration	47
8. Reference Design	48
9. Application Notes and Reference Designs	49
10. Customer Support	49
11. Register Table and Descriptions	50
12. Pin Descriptions: Si4030/31/32	51
13. Ordering Information	52

Si4030/31/32-B1

- 14. Package Markings (Top Marks)53**
 - 14.1. Si4030/31/32 Top Mark53
 - 14.2. Top Mark Explanation53
- 15. Package Outline: Si4030/31/3254**
- 16. PCB Land Pattern: Si4030/31/3255**
- Document Change List57**
- Contact Information58**



LIST OF FIGURES

Figure 1. SPI Timing.....	15
Figure 2. SPI Timing—READ Mode.....	16
Figure 3. SPI Timing—Burst Write Mode.....	16
Figure 4. SPI Timing—Burst Read Mode.....	16
Figure 5. State Machine Diagram.....	17
Figure 6. TX Timing.....	21
Figure 7. Frequency Deviation.....	25
Figure 8. FSK vs. GFSK Spectrums.....	27
Figure 9. Microcontroller Connections.....	30
Figure 10. PLL Synthesizer Block Diagram.....	31
Figure 11. FIFO Threshold.....	34
Figure 12. Packet Structure.....	35
Figure 13. Multiple Packets in TX Packet Handler.....	36
Figure 14. Operation of Data Whitening, Manchester Encoding, and CRC.....	37
Figure 15. Manchester Coding Example.....	37
Figure 16. POR Glitch Parameters.....	39
Figure 17. General Purpose ADC Architecture.....	41
Figure 18. Temperature Ranges using ADC8.....	43
Figure 19. WUT Interrupt and WUT Operation.....	46
Figure 20. Si4031 Reference Design Schematic.....	48
Figure 21. 20-Pin Quad Flat No-Lead (QFN).....	54
Figure 22. PCB Land Pattern.....	55

LIST OF TABLES

Table 1. DC Characteristics ¹	7
Table 2. Synthesizer AC Electrical Characteristics ¹	8
Table 3. Transmitter AC Electrical Characteristics ¹	9
Table 4. Auxiliary Block Specifications ¹	10
Table 5. Digital IO Specifications (SDO, SDI, SCLK, nSEL, and nIRQ)	11
Table 6. GPIO Specifications (GPIO_0, GPIO_1, and GPIO_2)	11
Table 7. Absolute Maximum Ratings	12
Table 8. Operating Modes	14
Table 9. Serial Interface Timing Parameters	15
Table 10. Operating Modes Response Time	17
Table 11. Frequency Band Selection	23
Table 12. Packet Handler Registers	36
Table 13. POR Parameters	39
Table 14. Temperature Sensor Range	42
Table 15. Register Descriptions	50
Table 16. Package Dimensions	54
Table 17. PCB Land Pattern Dimensions	56

1. Electrical Specifications

Table 1. DC Characteristics¹

Parameter	Symbol	Conditions	Min	Typ	Max	Units
Supply Voltage Range	V_{DD}		1.8	3.0	3.6	V
Power Saving Modes	$I_{Shutdown}$	RC Oscillator, Main Digital Regulator, and Low Power Digital Regulator OFF ²	—	15	50	nA
	$I_{Standby}$	Low Power Digital Regulator ON (Register values retained) and Main Digital Regulator, and RC Oscillator OFF	—	450	800	nA
	I_{Sleep}	RC Oscillator and Low Power Digital Regulator ON (Register values retained) and Main Digital Regulator OFF	—	1	—	μ A
	$I_{Sensor-LBD}$	Main Digital Regulator and Low Battery Detector ON, Crystal Oscillator and all other blocks OFF ²	—	1	—	μ A
	$I_{Sensor-TS}$	Main Digital Regulator and Temperature Sensor ON, Crystal Oscillator and all other blocks OFF ²	—	1	—	μ A
	I_{Ready}	Crystal Oscillator and Main Digital Regulator ON, all other blocks OFF. Crystal Oscillator buffer disabled	—	800	—	μ A
TUNE Mode Current	I_{Tune}	Synthesizer and regulators enabled	—	8.5	—	mA
TX Mode Current —Si4032	$I_{TX_{+20}}$	txpow[2:0] = 111 (+20 dBm) Using Silicon Labs' Reference Design. TX current consumption is dependent on match and board layout.	—	85	—	mA
TX Mode Current —Si4030/31	$I_{TX_{+13}}$	txpow[2:0] = 111 (+13 dBm) Using Silicon Labs' Reference Design. TX current consumption is dependent on match and board layout.	—	30	—	mA
	$I_{TX_{+1}}$	txpow[2:0] = 011 (+1 dBm) Using Silicon Labs' Reference Design. TX current consumption is dependent on match and board layout.	—	18	—	mA
Notes:						
1. All specification guaranteed by production test unless otherwise noted. Production test conditions and max limits are listed in the "Production Test Conditions" section on page 13.						
2. Guaranteed by qualification. Qualification test conditions are listed in the "Production Test Conditions" section on page 13.						

Si4030/31/32-B1

Table 2. Synthesizer AC Electrical Characteristics¹

Parameter	Symbol	Conditions	Min	Typ	Max	Units
Synthesizer Frequency Range—Si4031/32	F_{SYN}		240	—	930	MHz
Synthesizer Frequency Range—Si4030	F_{SYN}		900	—	960	MHz
Synthesizer Frequency Resolution ²	$F_{\text{RES-LB}}$	Low Band, 240–480 MHz	—	156.25	—	Hz
	$F_{\text{RES-HB}}$	High Band, 480–960 MHz	—	312.5	—	Hz
Reference Frequency Input Level ²	$f_{\text{REF-LV}}$	When using external reference signal driving XOUT pin, instead of using crystal. Measured peak-to-peak (V_{PP})	0.7	—	1.6	V
Synthesizer Settling Time ²	t_{LOCK}	Measured from exiting Ready mode with XOSC running to any frequency. Including VCO calibration.	—	200	—	μs
Residual FM ²	ΔF_{RMS}	Integrated over ± 250 kHz bandwidth (500 Hz lower bound of integration)	—	2	4	kHz_{RMS}
Phase Noise ²	$L\phi(f_M)$	$\Delta F = 10$ kHz	—	-80	—	dBc/Hz
		$\Delta F = 100$ kHz	—	-90	—	dBc/Hz
		$\Delta F = 1$ MHz	—	-115	—	dBc/Hz
		$\Delta F = 10$ MHz	—	-130	—	dBc/Hz

Notes:

1. All specification guaranteed by production test unless otherwise noted. Production test conditions and max limits are listed in the "Production Test Conditions" section on page 13.
2. Guaranteed by qualification. Qualification test conditions are listed in the "Production Test Conditions" section on page 13.

Table 3. Transmitter AC Electrical Characteristics¹

Parameter	Symbol	Conditions	Min	Typ	Max	Units
TX Frequency Range—Si4031/32	F_{TX}		240	—	930	MHz
TX Frequency Range—Si4030	F_{TX}		900	—	960	MHz
FSK Data Rate ²	DR_{FSK}		0.123	—	256	kbps
OOK Data Rate ²	DR_{OOK}		0.123	—	40	kbps
Modulation Deviation	Δf_1	860–960 MHz	± 0.625		± 320	kHz
	Δf_2	240–860 MHz	± 0.625		± 160	kHz
Modulation Deviation Resolution ²	Δf_{RES}		—	0.625	—	kHz
Output Power Range —Si4032 ³	P_{TX}		+1	—	+20	dBm
Output Power Range—Si4030/31 ³	P_{TX}		–8	—	+13	dBm
TX RF Output Steps ²	ΔP_{RF_OUT}	controlled by txpow[2:0]	—	3	—	dB
TX RF Output Level ² Variation vs. Temperature	ΔP_{RF_TEMP}	–40 to +85 °C	—	2	—	dB
TX RF Output Level Variation vs. Frequency ²	ΔP_{RF_FREQ}	Measured across any one frequency band	—	1	—	dB
Transmit Modulation Filtering ²	B*T	Gaussian Filtering Bandwidth Time Product	—	0.5	—	
Spurious Emissions ²	P_{OB-TX1}	$P_{OUT} = 13$ dBm, Frequencies <1 GHz	—	—	–54	dBm
	P_{OB-TX2}	1–12.75 GHz, excluding harmonics	—	—	–54	dBm
Harmonics ²	P_{2HARM}	Using reference design TX matching network and filter with max output power. Harmonics reduce linearly with output power.	—	—	–42	dBm
	P_{3HARM}		—	—	–42	dBm

Notes:

1. All specification guaranteed by production test unless otherwise noted. Production test conditions and max limits are listed in the "Production Test Conditions" section on page 13.
2. Guaranteed by qualification. Qualification test conditions are listed in the "Production Test Conditions" section on page 13.
3. Output power is dependent on matching components and board layout.

Table 4. Auxiliary Block Specifications¹

Parameter	Symbol	Conditions	Min	Typ	Max	Units
Temperature Sensor Accuracy ²	TS _A	After calibrated via sensor offset register t _{vo} ffs[7:0]	—	0.5	—	°C
Temperature Sensor Sensitivity ²	TS _S		—	5	—	mV/°C
Low Battery Detector Resolution ²	LBD _{RES}		—	50	—	mV
Low Battery Detector Conversion Time ²	LBD _{CT}		—	250	—	μs
Microcontroller Clock Output Frequency	F _{MC}	Configurable to 30 MHz, 15 MHz, 10 MHz, 4 MHz, 3 MHz, 2 MHz, 1 MHz, or 32.768 kHz	32.768K	—	30M	Hz
General Purpose ADC Resolution ²	ADC _{ENB}		—	8	—	bit
General Purpose ADC Bit Resolution ²	ADC _{RES}		—	4	—	mV/bit
Temp Sensor & General Purpose ADC Conversion Time ²	ADC _{CT}		—	305	—	μs
30 MHz XTAL Start-Up time	t _{30M}	Using XTAL and board layout in reference design. Start-up time will vary with XTAL type and board layout.	—	600	—	μs
30 MHz XTAL Cap Resolution ²	30M _{RES}		—	97	—	fF
32 kHz XTAL Start-Up Time ²	t _{32k}		—	6	—	sec
32 kHz XTAL Accuracy using 32 kHz XTAL ²	32K _{RES}	Using 20 ppm 32 kHz Crystal	—	100	—	ppm
32 kHz Accuracy using Internal RC Oscillator ²	32KRC _{RES}		—	2500	—	ppm
POR Reset Time	t _{POR}		—	16	—	ms
Software Reset Time ²	t _{soft}		—	100	—	μs

Notes:

1. All specification guaranteed by production test unless otherwise noted. Production test conditions and max limits are listed in the "Production Test Conditions" section on page 13.
2. Guaranteed by qualification. Qualification test conditions are listed in the "Production Test Conditions" section on page 13.

Table 5. Digital IO Specifications (SDO, SDI, SCLK, nSEL, and nIRQ)

Parameter	Symbol	Conditions	Min	Typ	Max	Units
Rise Time	T_{RISE}	$0.1 \times V_{DD}$ to $0.9 \times V_{DD}$, $C_L = 5$ pF	—	—	8	ns
Fall Time	T_{FALL}	$0.9 \times V_{DD}$ to $0.1 \times V_{DD}$, $C_L = 5$ pF	—	—	8	ns
Input Capacitance	C_{IN}		—	—	1	pF
Logic High Level Input Voltage	V_{IH}		$V_{DD} - 0.6$	—	—	V
Logic Low Level Input Voltage	V_{IL}		—	—	0.6	V
Input Current	I_{IN}	$0 < V_{IN} < V_{DD}$	-100	—	100	nA
Logic High Level Output Voltage	V_{OH}	$I_{OH} < 1$ mA source, $V_{DD} = 1.8$ V	$V_{DD} - 0.6$	—	—	V
Logic Low Level Output Voltage	V_{OL}	$I_{OL} < 1$ mA sink, $V_{DD} = 1.8$ V	—	—	0.6	V

Note: All specifications guaranteed by qualification. Qualification test conditions are listed in the "Production Test Conditions" section on page 13.

Table 6. GPIO Specifications (GPIO_0, GPIO_1, and GPIO_2)

Parameter	Symbol	Conditions	Min	Typ	Max	Units
Rise Time	T_{RISE}	$0.1 \times V_{DD}$ to $0.9 \times V_{DD}$, $C_L = 10$ pF, DRV<1:0>=HH	—	—	8	ns
Fall Time	T_{FALL}	$0.9 \times V_{DD}$ to $0.1 \times V_{DD}$, $C_L = 10$ pF, DRV<1:0>=HH	—	—	8	ns
Input Capacitance	C_{IN}		—	—	1	pF
Logic High Level Input Voltage	V_{IH}		$V_{DD} - 0.6$	—	—	V
Logic Low Level Input Voltage	V_{IL}		—	—	0.6	V
Input Current	I_{IN}	$0 < V_{IN} < V_{DD}$	-100	—	100	nA
Input Current If Pullup is Activated	I_{INP}	$V_{IL} = 0$ V	5	—	25	μ A
Maximum Output Current	I_{OmaxLL}	DRV<1:0>=LL	0.1	0.5	0.8	mA
	I_{OmaxLH}	DRV<1:0>=LH	0.9	2.3	3.5	mA
	I_{OmaxHL}	DRV<1:0>=HL	1.5	3.1	4.8	mA
	I_{OmaxHH}	DRV<1:0>=HH	1.8	3.6	5.4	mA
Logic High Level Output Voltage	V_{OH}	$I_{OH} < I_{Omax}$ source, $V_{DD} = 1.8$ V	$V_{DD} - 0.6$	—	—	V
Logic Low Level Output Voltage	V_{OL}	$I_{OL} < I_{Omax}$ sink, $V_{DD} = 1.8$ V	—	—	0.6	V

Note: All specifications guaranteed by qualification. Qualification test conditions are listed in the "Production Test Conditions" section on page 13.

Table 7. Absolute Maximum Ratings

Parameter	Value	Unit
V_{DD} to GND	-0.3, +3.6	V
Instantaneous $V_{RF-peak}$ to GND on TX Output Pin	-0.3, +8.0	V
Sustained $V_{RF-peak}$ to GND on TX Output Pin	-0.3, +6.5	V
Voltage on Digital Control Inputs	-0.3, $V_{DD} + 0.3$	V
Voltage on Analog Inputs	-0.3, $V_{DD} + 0.3$	V
Operating Ambient Temperature Range T_A	-40 to +85	°C
Thermal Impedance θ_{JA}	30	°C/W
Junction Temperature T_J	+125	°C
Storage Temperature Range T_{STG}	-55 to +125	°C
Note: Stresses beyond those listed under “Absolute Maximum Ratings” may cause permanent damage to the device. These are stress ratings only and functional operation of the device at or beyond these ratings in the operational sections of the specifications is not implied. Exposure to absolute maximum rating conditions for extended periods may affect device reliability. Power Amplifier may be damaged if switched on without proper load or termination connected. TX matching network design will influence TX $V_{RF-peak}$ on TX output pin. Caution: ESD sensitive device.		

1.1. Definition of Test Conditions

Production Test Conditions:

- $T_A = +25\text{ }^\circ\text{C}$
- $V_{DD} = +3.3\text{ VDC}$
- TX output power measured at 915 MHz
- External reference signal (XOUT) = 1.0 V_{PP} at 30 MHz, centered around 0.8 VDC
- Production test schematic (unless noted otherwise)
- All RF output levels referred to the pins of the Si4030/31/32 (not the RF module)

Qualification Test Conditions:

- $T_A = -40\text{ to }+85\text{ }^\circ\text{C}$
- $V_{DD} = +1.8\text{ to }+3.6\text{ VDC}$
- Using 4032, 4031, or 4030 reference design or production test schematic
- All RF output levels referred to the pins of the Si4030/31/32 (not the RF module)

2. Functional Description

The Si4030/31/32 are ISM wireless transmitters with continuous frequency tuning over their specified bands which encompasses 240–960 MHz. The wide operating voltage range of 1.8–3.6 V and low current consumption makes the Si4030/31/32 an ideal solution for battery powered applications.

The RF carrier is generated by an integrated VCO and $\Delta\Sigma$ Fractional-N PLL synthesizer. The synthesizer is designed to support configurable data rates, output frequency, frequency deviation, and Gaussian filtering at any frequency between 240–960 MHz. The transmit FSK data is modulated directly into the $\Delta\Sigma$ data stream and can be shaped by a Gaussian low-pass filter to reduce unwanted spectral content.

The Si4032's PA output power can be configured between +1 and +20 dBm in 3 dB steps, while the Si4030/31's PA output power can be configured between –8 and +13 dBm in 3 dB steps. The PA is single-ended to allow for easy antenna matching and low BOM cost. The PA incorporates automatic ramp-up and ramp-down control to reduce unwanted spectral spreading. The +20 dBm power amplifier of the Si4032 can also be used to compensate for the reduced performance of a lower cost, lower performance antenna or antenna with size constraints due to a small form-factor. Competing solutions require large and expensive external PAs to achieve comparable performance.

The Si4030/31/32 is designed to work with a microcontroller, crystal, and a few external components to create a very low cost system. Voltage regulators are integrated on-chip which allows for a wide operating supply voltage range from +1.8 to +3.6 V. A standard 4-pin SPI bus is used to communicate with an external microcontroller. Three configurable general purpose I/Os are available. A complete list of the available GPIO functions is available in “AN466: Si4030/31/32 Register Descriptions.”

2.1. Operating Modes

The Si4030/31/32 provides several operating modes which can be used to optimize the power consumption for a given application.

Table 8 summarizes the operating modes of the Si4030/31/32. In general, any given operating mode may be classified as an active mode or a power saving mode. The table indicates which block(s) are enabled (active) in each corresponding mode. With the exception of the SHUTDOWN mode, all can be dynamically selected by sending the appropriate commands over the SPI. An “X” in any cell means that, in the given mode of operation, that block can be independently programmed to be either ON or OFF, without noticeably impacting the current consumption. The SPI circuit block includes the SPI interface hardware and the device register space. The 32 kHz OSC block includes the 32.768 kHz RC oscillator or 32.768 kHz crystal oscillator and wake-up timer. AUX (Auxiliary Blocks) includes the temperature sensor, general purpose ADC, and low-battery detector.

Table 8. Operating Modes

Mode Name	Circuit Blocks							I _{VDD}
	Digital LDO	SPI	32 kHz OSC	AUX	30 MHz XTAL	PLL	PA	
SHUTDOWN	OFF (Register contents lost)	OFF	OFF	OFF	OFF	OFF	OFF	15 nA
STANDBY	ON (Register contents retained)	ON	OFF	OFF	OFF	OFF	OFF	450 nA
SLEEP		ON	ON	X	OFF	OFF	OFF	1 μ A
SENSOR		ON	X	ON	OFF	OFF	OFF	1 μ A
READY		ON	X	X	ON	OFF	OFF	800 μ A
TUNING		ON	X	X	ON	ON	OFF	8.5 mA
TRANSMIT		ON	X	X	ON	ON	ON	30 mA*

*Note: Using Si4030/31 at +13 dBm using recommended reference design.

3. Controller Interface

3.1. Serial Peripheral Interface (SPI)

The Si4030/31/32 communicates with the host MCU over a standard 3-wire SPI interface: SCLK, SDI, and nSEL. The host MCU can read data from the device on the SDO output pin. A SPI transaction is a 16-bit sequence which consists of a Read-Write ($\overline{R/W}$) select bit, followed by a 7-bit address field (ADDR), and an 8-bit data field (DATA) as demonstrated in Figure 1. The 7-bit address field is used to select one of the 128, 8-bit control registers. The $\overline{R/W}$ select bit determines whether the SPI transaction is a read or write transaction. If $\overline{R/W} = 1$ it signifies a WRITE transaction, while $\overline{R/W} = 0$ signifies a READ transaction. The contents (ADDR or DATA) are latched into the Si4030/31/32 every eight clock cycles. The timing parameters for the SPI interface are shown in Table 9. The SCLK rate is flexible with a maximum rate of 10 MHz.

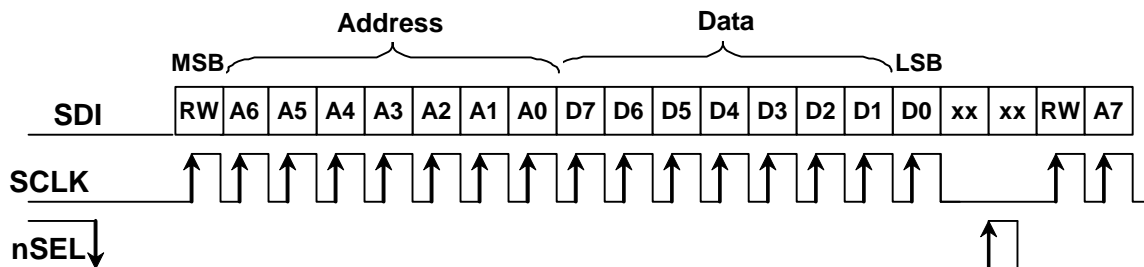

Figure 1. SPI Timing

Table 9. Serial Interface Timing Parameters

Symbol	Parameter	Min (nsec)	Diagram
t_{CH}	Clock high time	40	
t_{CL}	Clock low time	40	
t_{DS}	Data setup time	20	
t_{DH}	Data hold time	20	
t_{DD}	Output data delay time	20	
t_{EN}	Output enable time	20	
t_{DE}	Output disable time	50	
t_{SS}	Select setup time	20	
t_{SH}	Select hold time	50	
t_{SW}	Select high period	80	

To read back data from the Si4030/31/32, the R/W bit must be set to 0 followed by the 7-bit address of the register from which to read. The 8 bit DATA field following the 7-bit ADDR field is ignored on the SDI pin when $R/W = 0$. The next eight negative edge transitions of the SCLK signal will clock out the contents of the selected register. The data read from the selected register will be available on the SDO output pin. The READ function is shown in Figure 2. After the READ function is completed the SDO pin will remain at either a logic 1 or logic 0 state depending on the last data bit clocked out (D0). When nSEL goes high the SDO output pin will be pulled high by internal pullup.

Si4030/31/32-B1



Figure 2. SPI Timing—READ Mode

The SPI interface contains a burst read/write mode which allows for reading/writing sequential registers without having to re-send the SPI address. When the nSEL bit is held low while continuing to send SCLK pulses, the SPI interface will automatically increment the ADDR and read from/write to the next address. An example burst write transaction is illustrated in Figure 3 and a burst read in Figure 4. As long as nSEL is held low, input data will be latched into the Si4030/31/32 every eight SCLK cycles.



Figure 3. SPI Timing—Burst Write Mode

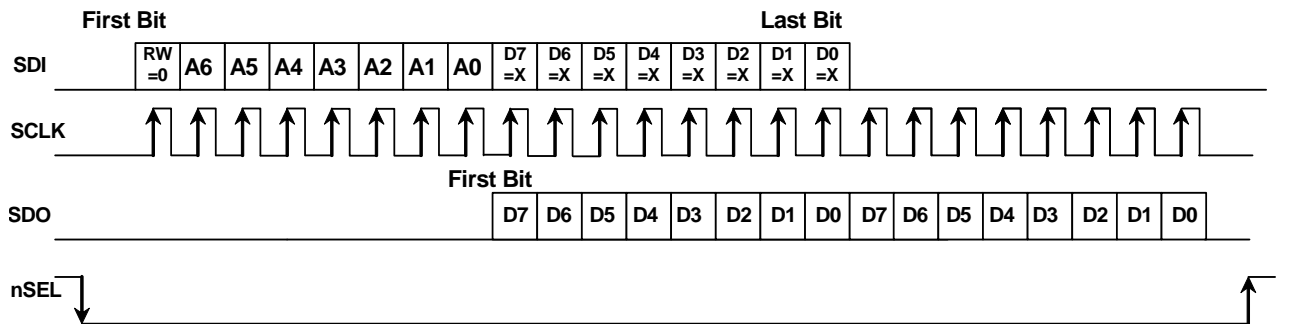

Figure 4. SPI Timing—Burst Read Mode

3.2. Operating Mode Control

There are three primary states in the Si4030/31/32 radio state machine: SHUTDOWN, IDLE, and TX (see Figure 5). The SHUTDOWN state completely shuts down the radio to minimize current consumption. There are five different configurations/options for the IDLE state which can be selected to optimize the chip to the applications needs. "Register 07h. Operating Mode and Function Control 1" controls which operating mode/state is selected with the exception of SHUTDOWN which is controlled by SDN pin 20. The TX state may be reached automatically from any of the IDLE states by setting the txon bit in "Register 07h. Operating Mode and Function Control 1." Table 10 shows each of the operating modes with the time required to reach TX mode as well as the current consumption of each mode.

The Si4030/31/32 includes a low-power digital regulated supply (LPLDO) which is internally connected in parallel to the output of the main digital regulator (and is available externally at the VR_DIG pin). This common digital supply voltage is connected to all digital circuit blocks including the SPI and register space. The LPLDO has extremely low quiescent current consumption but limited current supply capability; it is used only in the IDLE-STANDBY and IDLE-SLEEP modes. The main digital regulator is automatically enabled in all other modes.



Figure 5. State Machine Diagram

Table 10. Operating Modes Response Time

State/Mode	Response Time to TX	Current in State/Mode [μA]
Shut Down State	16.8 ms	15 nA
Idle States:		
Standby Mode	800 μs	450 nA
Sleep Mode	800 μs	1 μA
Sensor Mode	800 μs	1 μA
Ready Mode	200 μs	800 μA
Tune Mode	200 μs	8.5 mA
TX State	NA	Si4032: 85 mA @ +20 dBm, Si4030/31: 30 mA @ +13 dBm

3.2.1. SHUTDOWN State

The SHUTDOWN state is the lowest current consumption state of the device with nominally less than 15 nA of current consumption. The SHUTDOWN state may be entered by driving the SDN pin (Pin 20) high. The SDN pin should be held low in all states except the SHUTDOWN state. In the SHUTDOWN state, the contents of the registers are lost and there is no SPI access.

When the chip is connected to the power supply, a POR will be initiated after the falling edge of SDN.

3.2.2. IDLE State

There are five different modes in the IDLE state which may be selected by "Register 07h. Operating Mode and Function Control 1". All modes have a tradeoff between current consumption and response time to TX mode. This tradeoff is shown in Table 10. After the POR event, SWRESET, or exiting from the SHUTDOWN state the chip will default to the IDLE-READY mode. After a POR event the interrupt registers must be read to properly enter the SLEEP, SENSOR, or STANDBY mode and to control the 32 kHz clock correctly.

3.2.2.1. STANDBY Mode

STANDBY mode has the lowest current consumption of the five IDLE states with only the LPLDO enabled to maintain the register values. In this mode the registers can be accessed in both read and write mode. The STANDBY mode can be entered by writing 0h to "Register 07h. Operating Mode and Function Control 1". If an interrupt has occurred (i.e., the nIRQ pin = 0) the interrupt registers must be read to achieve the minimum current consumption. Additionally, the ADC should not be selected as an input to the GPIO in this mode as it will cause excess current consumption.

3.2.2.2. SLEEP Mode

In SLEEP mode the LPLDO is enabled along with the Wake-Up-Timer, which can be used to accurately wake-up the radio at specified intervals. See "7.6. Wake-Up Timer" on page 45 for more information on the Wake-Up-Timer. SLEEP mode is entered by setting enwt = 1 (40h) in "Register 07h. Operating Mode and Function Control 1". If an interrupt has occurred (i.e., the nIRQ pin = 0) the interrupt registers must be read to achieve the minimum current consumption. Also, the ADC should not be selected as an input to the GPIO in this mode as it will cause excess current consumption.

3.2.2.3. SENSOR Mode

In SENSOR Mode either the Low Battery Detector, Temperature Sensor, or both may be enabled in addition to the LPLDO and Wake-Up-Timer. The Low Battery Detector can be enabled by setting enlbd = 1 in "Register 07h. Operating Mode and Function Control 1". See "7.4. Temperature Sensor" on page 42 and "7.5. Low Battery Detector" on page 44 for more information on these features. If an interrupt has occurred (i.e., the nIRQ pin = 0) the interrupt registers must be read to achieve the minimum current consumption.

3.2.2.4. READY Mode

READY Mode is designed to give a fast transition time to TX mode with reasonable current consumption. In this mode the Crystal oscillator remains enabled reducing the time required to switch to TX mode by eliminating the crystal start-up time. READY mode is entered by setting xton = 1 in "Register 07h. Operating Mode and Function Control 1". To achieve the lowest current consumption state the crystal oscillator buffer should be disabled in "Register 62h. Crystal Oscillator Control and Test."

3.2.2.5. TUNE Mode

In TUNE Mode the PLL remains enabled in addition to the other blocks enabled in the IDLE modes. This will give the fastest response to TX mode as the PLL will remain locked but it results in the highest current consumption. This mode of operation is designed for frequency hopping spread spectrum systems (FHSS). TUNE mode is entered by setting pllcn = 1 in "Register 07h. Operating Mode and Function Control 1". It is not necessary to set xton to 1 for this mode, the internal state machine automatically enables the crystal oscillator.

3.2.3. TX State

The TX state may be entered from any of the IDLE modes when the txon bit is set to 1 in "Register 07h. Operating Mode and Function Control 1". A built-in sequencer takes care of all the actions required to transition between states from enabling the crystal oscillator to ramping up the PA. The following sequence of events will occur automatically when going from STANDBY mode to TX mode by setting the txon bit.

1. Enable the main digital LDO and the Analog LDOs.
2. Start up crystal oscillator and wait until ready (controlled by an internal timer).
3. Enable PLL.
4. Calibrate VCO (this action is skipped when the vcocal bit is "0", default value is "1").
5. Wait until PLL settles to required transmit frequency (controlled by timer).
6. Activate power amplifier and wait until power ramping is completed (controlled by an internal timer).
7. Transmit packet.

Steps in this sequence may be eliminated depending on which IDLE mode the chip is configured to prior to setting the txon bit. By default, the VCO and PLL are calibrated every time the PLL is enabled.

3.2.4. Device Status

Add	R/W	Function/Description	D7	D6	D5	D4	D3	D2	D1	D0	POR Def.
02	R	Device Status	ffovfl	ffunfl	Reserved	Reserved	freqerr		cps[1]	cps[0]	—

The operational status of the chip can be read from "Register 02h. Device Status".

3.3. Interrupts

The Si4030/31/32 is capable of generating an interrupt signal when certain events occur. The chip notifies the microcontroller that an interrupt event has occurred by setting the nIRQ output pin LOW = 0. This interrupt signal will be generated when any one (or more) of the interrupt events (corresponding to the Interrupt Status bits) shown below occur. The nIRQ pin will remain low until the microcontroller reads the Interrupt Status Register(s) (Registers 03h–04h) containing the active Interrupt Status bit. The nIRQ output signal will then be reset until the next change in status is detected. The interrupts must be enabled by the corresponding enable bit in the Interrupt Enable Registers (Registers 05h–06h). All enabled interrupt bits will be cleared when the microcontroller reads the interrupt status register. If the interrupt is not enabled when the event occurs it will not trigger the nIRQ pin, but the status may still be read at anytime in the Interrupt Status registers.

Add	R/W	Function/Description	D7	D6	D5	D4	D3	D2	D1	D0	POR Def.
03	R	Interrupt Status 1	ifferr	itxffafull	itxffaem	Reserved	iext	ipksent	Reserved	Reserved	—
04	R	Interrupt Status 2	Reserved	Reserved	Reserved	Reserved	iwut	ilbd	ichiprdy	ipor	—
05	R/W	Interrupt Enable 1	enfferr	entxffafull	entxffaem	Reserved	enext	enpksent	Reserved	Reserved	00h
06	R/W	Interrupt Enable 2	Reserved	Reserved	Reserved	Reserved	enwut	enlbd	enchiprdy	enpor	01h

See “AN466: Si4030/31/32 Register Descriptions” for a complete list of interrupts.

3.4. System Timing

The system timing for TX mode is shown in Figure 6. The figures demonstrate transitioning from STANDBY mode to TX mode through the built-in sequencer of required steps. The user only needs to program the desired mode, and the internal sequencer will properly transition the part from its current mode.

The VCO will automatically calibrate at every frequency change or power up. The PLL T0 time is to allow for bias settling of the VCO. The PLL TS time is for the settling time of the PLL, which has a default setting of 100 μs. The total time for PLL T0, PLL CAL, and PLL TS under all conditions is 200 μs. Under certain applications, the PLL T0 time and the PLL CAL may be skipped for faster turn-around time. Contact applications support if faster turnaround time is desired.



Figure 6. TX Timing

3.5. Frequency Control

For calculating the necessary frequency register settings it is recommended that customers use Silicon Labs' Wireless Design Suite (WDS) or the EZRadioPRO Register Calculator worksheet (in Microsoft Excel) available on the product website. These methods offer a simple method to quickly determine the correct settings based on the application requirements. The following information can be used to calculate these values manually.

3.5.1. Frequency Programming

In order to transmit an RF signal, the desired channel frequency, $f_{carrier}$, must be programmed into the Si4030/31/32. Note that this frequency is the center frequency of the desired channel. The carrier frequency is generated by a Fractional-N Synthesizer, using 10 MHz both as the reference frequency and the clock of the (3rd order) $\Delta\Sigma$ modulator. This modulator uses modulo 64000 accumulators. This design was made to obtain the desired frequency resolution of the synthesizer. The overall division ratio of the feedback loop consists of an integer part (N) and a fractional part (F). In a generic sense, the output frequency of the synthesizer is as follows:

$$f_{OUT} = 10MHz \times (N + F)$$

The fractional part (F) is determined by three different values, Carrier Frequency (fc[15:0]), Frequency Offset (fo[8:0]), and Frequency Deviation (fd[7:0]). Due to the fine resolution and high loop bandwidth of the synthesizer, FSK modulation is applied inside the loop and is done by varying F according to the incoming data; this is discussed further in "3.5.4. Frequency Deviation" on page 24. Also, a fixed offset can be added to fine-tune the carrier frequency and counteract crystal tolerance errors. For simplicity assume that only the fc[15:0] register will determine the fractional component. The equation for selection of the carrier frequency is shown below:

$$f_{carrier} = 10MHz \times (hbssel + 1) \times (N + F)$$

$$f_{TX} = 10MHz * (hbssel + 1) * (fb[4:0] + 24 + \frac{fc[15:0]}{64000})$$

Add	R/W	Function/Description	D7	D6	D5	D4	D3	D2	D1	D0	POR Def.
73	R/W	Frequency Offset 1	fo[7]	fo[6]	fo[5]	fo[4]	fo[3]	fo[2]	fo[1]	fo[0]	00h
74	R/W	Frequency Offset 2							fo[9]	fo[8]	00h
75	R/W	Frequency Band Select		sbsel	hbssel	fb[4]	fb[3]	fb[2]	fb[1]	fb[0]	35h
76	R/W	Nominal Carrier Frequency 1	fc[15]	fc[14]	fc[13]	fc[12]	fc[11]	fc[10]	fc[9]	fc[8]	BBh
77	R/W	Nominal Carrier Frequency 0	fc[7]	fc[6]	fc[5]	fc[4]	fc[3]	fc[2]	fc[1]	fc[0]	80h

The integer part (N) is determined by fb[4:0]. Additionally, the output frequency can be halved by connecting a ÷2 divider to the output. This divider is not inside the loop and is controlled by the hbssel bit in "Register 75h. Frequency Band Select". This effectively partitions the entire 240–960 MHz frequency range into two separate bands: High Band (HB) for hbssel = 1, and Low Band (LB) for hbssel = 0. The valid range of fb[4:0] is from 0 to 23. If a higher value is written into the register, it will default to a value of 23. The integer part has a fixed offset of 24 added to it as shown in the formula above. Table 11 demonstrates the selection of fb[4:0] for the corresponding frequency band.

After selection of the fb (N) the fractional component may be solved with the following equation:

$$fc[15:0] = \left(\frac{f_{TX}}{10MHz * (hbssel + 1)} - fb[4:0] - 24 \right) * 64000$$

fb and fc are the actual numbers stored in the corresponding registers.

Table 11. Frequency Band Selection

fb[4:0] Value	N	Frequency Band	
		hbsel=0	hbsel=1
0	24	240–249.9 MHz	480–499.9 MHz
1	25	250–259.9 MHz	500–519.9 MHz
2	26	260–269.9 MHz	520–539.9 MHz
3	27	270–279.9 MHz	540–559.9 MHz
4	28	280–289.9 MHz	560–579.9 MHz
5	29	290–299.9 MHz	580–599.9 MHz
6	30	300–309.9 MHz	600–619.9 MHz
7	31	310–319.9 MHz	620–639.9 MHz
8	32	320–329.9 MHz	640–659.9 MHz
9	33	330–339.9 MHz	660–679.9 MHz
10	34	340–349.9 MHz	680–699.9 MHz
11	35	350–359.9 MHz	700–719.9 MHz
12	36	360–369.9 MHz	720–739.9 MHz
13	37	370–379.9 MHz	740–759.9 MHz
14	38	380–389.9 MHz	760–779.9 MHz
15	39	390–399.9 MHz	780–799.9 MHz
16	40	400–409.9 MHz	800–819.9 MHz
17	41	410–419.9 MHz	820–839.9 MHz
18	42	420–429.9 MHz	840–859.9 MHz
19	43	430–439.9 MHz	860–879.9 MHz
20	44	440–449.9 MHz	880–899.9 MHz
21	45	450–459.9 MHz	900–919.9 MHz
22	46	460–469.9 MHz	920–939.9 MHz
23	47	470–479.9 MHz	940–960 MHz

3.5.2. Easy Frequency Programming for FHSS

While Registers 73h–77h may be used to program the carrier frequency of the Si4030/31/32, it is often easier to think in terms of “channels” or “channel numbers” rather than an absolute frequency value in Hz. Also, there may be some timing-critical applications (such as for Frequency Hopping Systems) in which it is desirable to change frequency by programming a single register. Once the channel step size is set, the frequency may be changed by a single register corresponding to the channel number. A nominal frequency is first set using Registers 73h–77h, as described above. Registers 79h and 7Ah are then used to set a channel step size and channel number, relative to the nominal setting. The Frequency Hopping Step Size (fhs[7:0]) is set in increments of 10 kHz with a maximum channel step size of 2.56 MHz. The Frequency Hopping Channel Select Register then selects channels based on multiples of the step size.

$$F_{carrier} = F_{nom} + fhs[7:0] \times (fhch[7:0] \times 10kHz)$$

For example, if the nominal frequency is set to 900 MHz using Registers 73h–77h, the channel step size is set to 1 MHz using "Register 7Ah. Frequency Hopping Step Size," and "Register 79h. Frequency Hopping Channel Select" is set to 5d, the resulting carrier frequency would be 905 MHz. Once the nominal frequency and channel step size are programmed in the registers, it is only necessary to program the fhch[7:0] register in order to change the frequency.

Add	R/W	Function/Description	D7	D6	D5	D4	D3	D2	D1	D0	POR Def.
79	R/W	Frequency Hopping Channel Select	fhch[7]	fhch[6]	fhch[5]	fhch[4]	fhch[3]	fhch[2]	fhch[1]	fhch[0]	00h
7A	R/W	Frequency Hopping Step Size	fhs[7]	fhs[6]	fhs[5]	fhs[4]	fhs[3]	fhs[2]	fhs[1]	fhs[0]	00h

3.5.3. Automatic State Transition for Frequency Change

If registers 79h or 7Ah are changed in TX mode, the state machine will automatically transition the chip back to TUNE and change the frequency. This feature is useful to reduce the number of SPI commands required in a Frequency Hopping System. This in turn reduces microcontroller activity, reducing current consumption. The exception to this is during TX FIFO mode. If a frequency change is initiated during a TX packet, then the part will complete the current TX packet and will only change the frequency for subsequent packets.

3.5.4. Frequency Deviation

The peak frequency deviation is configurable from ±0.625 to ±320 kHz. The Frequency Deviation (Δf) is controlled by the Frequency Deviation Register (fd), address 71 and 72h, and is independent of the carrier frequency setting. When enabled, regardless of the setting of the hbsel bit (high band or low band), the resolution of the frequency deviation will remain in increments of 625 Hz. When using frequency modulation the carrier frequency will deviate from the nominal center channel carrier frequency by $\pm\Delta f$:

$$\Delta f = fd[8:0] \times 625Hz$$

$$fd[8:0] = \frac{\Delta f}{625Hz} \quad \Delta f = \text{peak deviation}$$



Figure 7. Frequency Deviation

The previous equation should be used to calculate the desired frequency deviation. If desired, frequency modulation may also be disabled in order to obtain an unmodulated carrier signal at the channel center frequency; see "4.1. Modulation Type" on page 27 for further details.

Add	R/W	Function/Description	D7	D6	D5	D4	D3	D2	D1	D0	POR Def.
71	R/W	Modulation Mode Control 2	trclk[1]	trclk[0]	dtmod[1]	dtmod[0]	eninvs	fd[8]	modtyp[1]	modtyp[0]	00h
72	R/W	Frequency Deviation	fd[7]	fd[6]	fd[5]	fd[4]	fd[3]	fd[2]	fd[1]	fd[0]	20h

3.5.5. Frequency Offset Adjustment

A frequency offset can be adjusted manually by fo[9:0] in registers 73h and 74h. The frequency offset adjustment is implemented by shifting the Synthesizer Local Oscillator frequency. This register is a signed register so in order to get a negative offset it is necessary to take the twos complement of the positive offset number. The offset can be calculated by the following:

$$DesiredOffset = 156.25Hz \times (hbsel + 1) \times fo[9:0]$$

$$fo[9:0] = \frac{DesiredOffset}{156.25Hz \times (hbsel + 1)}$$

The adjustment range in high band is ±160 kHz and in low band it is ±80 kHz. For example to compute an offset of +50 kHz in high band mode fo[9:0] should be set to 0A0h. For an offset of -50 kHz in high band mode the fo[9:0] register should be set to 360h.

Add	R/W	Function/Description	D7	D6	D5	D4	D3	D2	D1	D0	POR Def.
73	R/W	Frequency Offset	fo[7]	fo[6]	fo[5]	fo[4]	fo[3]	fo[2]	fo[1]	fo[0]	00h
74	R/W	Frequency Offset							fo[9]	fo[8]	00h

3.5.6. TX Data Rate Generator

The data rate is configurable between 0.123–256 kbps. For data rates below 30 kbps the "txdtrtscale" bit in register 70h should be set to 1. When higher data rates are used this bit should be set to 0.

The TX data rate is determined by the following formula in kbps:

$$DR_TX \text{ (kbps)} = \frac{txdr[15:0] \times 1 \text{ MHz}}{2^{16 + 5 \times txdtrtscale}}$$

$$txdr[15:0] = \frac{DR_TX(\text{kbps}) \times 2^{16 + 5 \times txdtrtscale}}{1 \text{ MHz}}$$

Add	R/W	Function/Description	D7	D6	D5	D4	D3	D2	D1	D0	POR Def.
6E	R/W	TX Data Rate 1	txdr[15]	txdr[14]	txdr[13]	txdr[12]	txdr[11]	txdr[10]	txdr[9]	txdr[8]	0Ah
6F	R/W	TX Data Rate 0	txdr[7]	txdr[6]	txdr[5]	txdr[4]	txdr[3]	txdr[2]	txdr[1]	txdr[0]	AAh

4. Modulation Options

4.1. Modulation Type

The Si4030/31/32 supports three different modulation options: Gaussian Frequency Shift Keying (GFSK), Frequency Shift Keying (FSK), and On-Off Keying (OOK). GFSK is the recommended modulation type as it provides the best performance and cleanest modulation spectrum. Figure 8 demonstrates the difference between FSK and GFSK for a Data Rate of 64 kbps. The time domain plots demonstrate the effects of the Gaussian filtering. The frequency domain plots demonstrate the spectral benefit of GFSK over FSK. The type of modulation is selected with the modtyp[1:0] bits in "Register 71h. Modulation Mode Control 2." Note that it is also possible to obtain an unmodulated carrier signal by setting modtyp[1:0] = 00.

modtyp[1:0]	Modulation Source
00	Unmodulated Carrier
01	OOK
10	FSK
11	GFSK (enable TX Data CLK when direct mode is used)

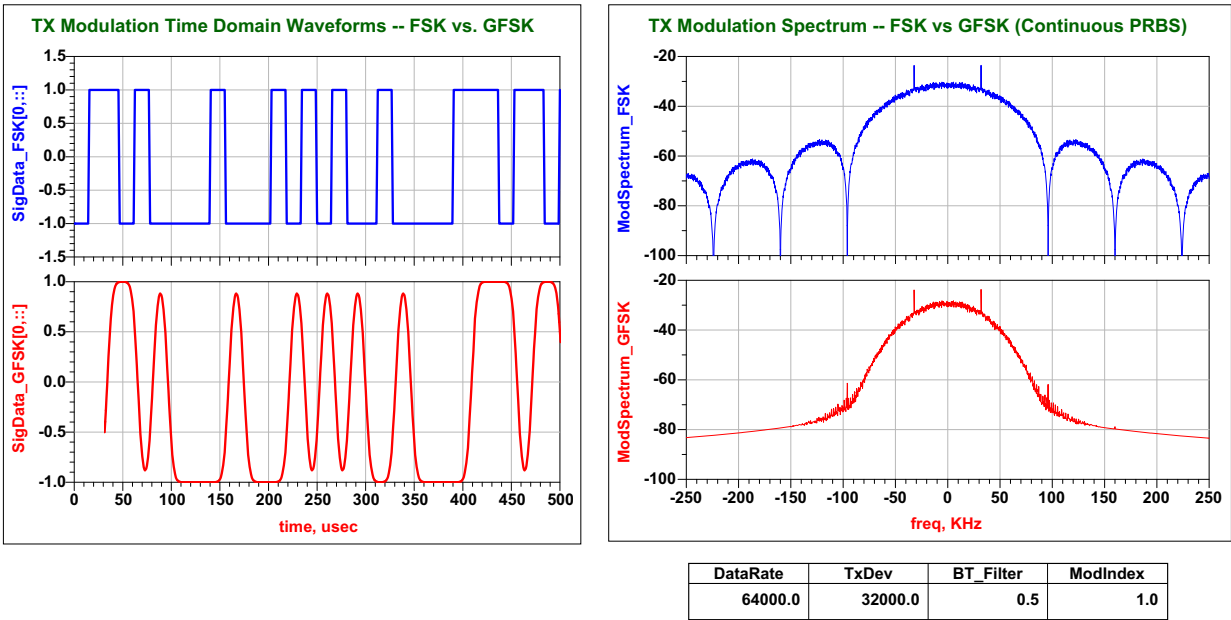

Figure 8. FSK vs. GFSK Spectrums

4.2. Modulation Data Source

The Si4030/31/32 may be configured to obtain its modulation data from one of three different sources: FIFO mode, Direct Mode, and from a PN9 mode. In Direct Mode, the TX modulation data may be obtained from several different input pins. These options are set through the dtmod[1:0] field in "Register 71h. Modulation Mode Control 2."

Add	R/W	Function/Description	D7	D6	D5	D4	D3	D2	D1	D0	POR Def.
71	R/W	Modulation Mode Control 2	trclk[1]	trclk[0]	dtmod[1]	dtmod[0]	eninv	fd[8]	modtyp[1]	modtyp[0]	00h

dtmod[1:0]	Data Source
00	Direct Mode using TX Data via GPIO pin (GPIO configuration required)
01	Direct Mode using TX Data via SDI pin (only when nSEL is high)
10	FIFO Mode
11	PN9 (internally generated)

4.2.1. FIFO Mode

In FIFO mode, the transmit data is stored in integrated FIFO register memory. The FIFOs are accessed via "Register 7Fh. FIFO Access," and are most efficiently accessed with burst read/write operation as discussed in "3.1. Serial Peripheral Interface (SPI)" on page 15.

In TX mode, the data bytes stored in FIFO memory are "packaged" together with other fields and bytes of information to construct the final transmit packet structure. These other potential fields include the Preamble, Sync word, Header, CRC checksum, etc. The configuration of the packet structure in TX mode is determined by the Automatic Packet Handler (if enabled), in conjunction with a variety of Packet Handler Registers (see Table 12 on page 36). If the Automatic Packet Handler is disabled, the entire desired packet structure should be loaded into FIFO memory; no other fields (such as Preamble or Sync word are automatically added to the bytes stored in FIFO memory). For further information on the configuration of the FIFOs for a specific application or packet size, see "6. Data Handling and Packet Handler" on page 34.

When in FIFO mode, the chip will automatically exit the TX State when either the ipksent or ipkvalid interrupt occurs. The chip will return to the IDLE mode state programmed in "Register 07h. Operating Mode and Function Control 1". For example, the chip may be placed into TX mode by setting the txon bit, but with the pllon bit additionally set. The chip will transmit all of the contents of the FIFO and the ipksent interrupt will occur. When this interrupt event occurs, the chip will clear the txon bit and return to TUNE mode, as indicated by the set state of the pllon bit. If no other bits are additionally set in register 07h (besides txon initially), then the chip will return to the STANDBY state.

4.2.2. Direct Mode

For legacy systems that perform packet handling within an MCU or other baseband chip, it may not be desirable to use the FIFO. For this scenario, a Direct Mode is provided which bypasses the FIFOs entirely.

In TX direct mode, the TX modulation data is applied to an input pin of the chip and processed in "real time" (i.e., not stored in a register for transmission at a later time). A variety of pins may be configured for use as the TX Data input function.

Furthermore, an additional pin may be required for a TX Clock output function if GFSK modulation is desired (only the TX Data input pin is required for FSK). Two options for the source of the TX Data are available in the dtmod[1:0] field, and various configurations for the source of the TX Data Clock may be selected through the trclk[1:0] field.

trclk[1:0]	TX Data Clock Configuration
00	No TX Clock (only for FSK)
01	TX Data Clock is available via GPIO (GPIO needs programming accordingly as well)
10	TX Data Clock is available via SDO pin (only when nSEL is high)
11	TX Data Clock is available via the nIRQ pin

The eninv bit in SPI Register 71h will invert the TX Data; this is most likely useful for diagnostic and testing purposes.

4.2.2.1. Direct Synchronous Mode

In TX direct mode, the chip may be configured for synchronous or asynchronous modes of modulation. In direct synchronous mode, the RFIC is configured to provide a TX Clock signal as an output to the external device that is providing the TX Data stream. This TX Clock signal is a square wave with a frequency equal to the programmed data rate. The external modulation source (e.g., MCU) must accept this TX Clock signal as an input and respond by providing one bit of TX Data back to the RFIC, synchronous with one edge of the TX Clock signal. In this fashion, the rate of the TX Data input stream from the external source is controlled by the programmed data rate of the RFIC; no TX Data bits are made available at the input of the RFIC until requested by another cycle of the TX Clock signal. The TX Data bits supplied by the external source are transmitted directly in real-time (i.e., not stored internally for later transmission).

All modulation types (FSK/GFSK/OOK) are valid in TX direct synchronous mode. As will be discussed in the next section, there are limits on modulation types in TX direct asynchronous mode.

4.2.2.2. Direct Asynchronous Mode

In TX direct asynchronous mode, the RFIC no longer controls the data rate of the TX Data input stream. Instead, the data rate is controlled only by the external TX Data source; the RFIC simply accepts the data applied to its TX Data input pin, at whatever rate it is supplied. This means that there is no longer a need for a TX Clock output signal from the RFIC, as there is no synchronous "handshaking" between the RFIC and the external data source. The TX Data bits supplied by the external source are transmitted directly in real-time (i.e., not stored internally for later transmission).

It is not necessary to program the data rate parameter when operating in TX direct asynchronous mode. The chip still internally samples the incoming TX Data stream to determine when edge transitions occur; however, rather than sampling the data at a pre-programmed data rate, the chip now internally samples the incoming TX Data stream at its maximum possible oversampling rate. This allows the chip to accurately determine the timing of the bit edge transitions without prior knowledge of the data rate. (Of course, it is still necessary to program the desired peak frequency deviation.)

Only FSK and OOK modulation types are valid in TX Direct Asynchronous Mode; GFSK modulation is not available in asynchronous mode. This is because the RFIC does not have knowledge of the supplied data rate, and thus cannot determine the appropriate Gaussian lowpass filter function to apply to the incoming data.

One advantage of this mode that it saves a microcontroller pin because no TX Clock output function is required. The primary disadvantage of this mode is the increase in occupied spectral bandwidth with FSK (as compared to GFSK).

4.2.2.3. Direct Mode using SPI or nIRQ Pins

In certain applications it may be desirable to minimize the connections to the microcontroller or to preserve the GPIOs for other uses. For these cases it is possible to use the SPI pins and nIRQ as the modulation clock and data. The SDO pin can be configured to be the data clock by programming trclk = 10. If the nSEL pin is LOW then the function of the pin will be SPI data output. If the pin is high and trclk[1:0] is 10 then during TX mode the data clock will be available on the SDO pin. If trclk[1:0] is set to 11 and no interrupts are enabled in registers 05 or 06h, then the nIRQ pin can also be used as the TX data clock.

The SDI pin can be configured to be the data source in TX mode if dtmod[1:0] = 01. In a similar fashion, if nSEL is LOW the pin will function as SPI data-in. If nSEL is HIGH then in TX mode it will be the data to be modulated and transmitted. Figure 9 demonstrates using SDI and SDO as the TX data and clock:



Figure 9. Microcontroller Connections

If the SDO pin is not used for data clock then it may be programmed to be the interrupt function (nIRQ) by programming Reg 0Eh bit 3.

4.2.3. PN9 Mode

In this mode the TX Data is generated internally using a pseudorandom (PN9 sequence) bit generator. The primary purpose of this mode is for use as a test mode to observe the modulated spectrum without having to provide data.

5. Internal Functional Blocks

This section provides an overview some of the key blocks of the internal radio architecture.

5.1. Synthesizer

An integrated Sigma Delta ($\Sigma\Delta$) Fractional-N PLL synthesizer capable of operating from 240–960 MHz is provided on-chip. The Si4031/32 and Si4030 cover different frequencies. This section discusses the frequency range covered by all EZRadioPRO devices. Using a $\Sigma\Delta$ synthesizer has many advantages; it provides flexibility in choosing data rate, deviation, channel frequency, and channel spacing. The transmit modulation is applied directly to the loop in the digital domain through the fractional divider which results in very precise accuracy and control over the transmit deviation.

Depending on the part, the PLL and Δ - Σ modulator scheme is designed to support any desired frequency and channel spacing in the range from 240–960 MHz with a frequency resolution of 156.25 Hz (Low band) or 312.5 Hz (High band). The transmit data rate can be programmed between 0.123–256 kbps, and the frequency deviation can be programmed between ± 1 –320 kHz. These parameters may be adjusted via registers as shown in "3.5. Frequency Control" on page 22.



Figure 10. PLL Synthesizer Block Diagram

The reference frequency to the PLL is 10 MHz. The PLL utilizes a differential L-C VCO, with integrated on-chip inductors. The output of the VCO is followed by a configurable divider which will divide down the signal to the desired output frequency band. The modulus of this divider stage is controlled dynamically by the output from the Δ - Σ modulator. The tuning resolution is sufficient to tune to the commanded frequency with a maximum accuracy of 312.5 Hz anywhere in the range between 240–960 MHz.

5.1.1. VCO

The output of the VCO is automatically divided down to the correct output frequency depending on the `hbssel` and `fb[4:0]` fields in "Register 75h. Frequency Band Select." The VCO integrates the resonator inductor, tuning varactor, so no external VCO components are required.

The VCO uses a capacitance bank to cover the wide frequency range specified. The capacitance bank will automatically be calibrated every time the synthesizer is enabled. In certain fast hopping applications this might not be desirable so the VCO calibration may be skipped by setting the appropriate register.

5.2. Power Amplifier

The Si4032 contains an internal integrated power amplifier (PA) capable of transmitting at output levels between -1 and $+20$ dBm. The Si4030/31 contains a PA which is capable of transmitting output levels between -8 to $+13$ dBm. The PA design is single-ended and is implemented as a two stage class CE amplifier with a high efficiency when transmitting at maximum power. The PA efficiency can only be optimized at one power level. Changing the output power by adjusting `txpow[2:0]` will scale both the output power and current but the efficiency will not be constant. The PA output is ramped up and down to prevent unwanted spectral splatter.

Si4030/31/32-B1

5.2.1. Output Power Selection

With the Si4032, the output power is configurable in 3 dB steps with the txpow[2:0] field in "Register 6Dh. TX Power." Extra output power can allow the use of a cheaper, smaller antenna reducing the overall BOM cost. The higher power setting of the chip achieves maximum possible range, but of course comes at the cost of higher TX current consumption. However, depending on the duty cycle of the system, the effect on battery life may be insignificant. Contact Silicon Labs Support for help in evaluating this tradeoff.

The +13 dBm output power of the Si4030/31 is targeted at systems that require lower output power. The PA still offers high efficiency and a range of output power from -8 to +13 dBm.

Add	R/W	Function/Description	D7	D6	D5	D4	D3	D2	D1	D0	POR Def.
6D	R/W	TX Power						txpow[2]	txpow[1]	txpow[0]	07h

txpow[2:0]	Si4032 Output Power
000	+1 dBm
001	+2 dBm
010	+5 dBm
011	+8 dBm
100	+11 dBm
101	+14 dBm
110	+17 dBm
111	+20 dBm

txpow[2:0]	Si4030/31 Output Power
000	-8 dBm
001	-5 dBm
010	-2 dBm
011	+1 dBm
100	+4 dBm
101	+7 dBm
110	+10 dBm
111	+13 dBm

5.3. Crystal Oscillator

The Si4030/31/32 includes an integrated 30 MHz crystal oscillator with a fast start-up time of less than 600 μ s when a suitable parallel resonant crystal is used. The design is differential with the required crystal load capacitance integrated on-chip to minimize the number of external components. By default, all that is required off-chip is the 30 MHz crystal.

The crystal load capacitance can be digitally programmed to accommodate crystals with various load capacitance requirements and to adjust the frequency of the crystal oscillator. The tuning of the crystal load capacitance is programmed through the xlc[6:0] field of "Register 09h. 30 MHz Crystal Oscillator Load Capacitance." The total internal capacitance is 12.5 pF and is adjustable in approximately 127 steps (97fF/step). The xtalshift bit is a coarse shift in frequency but is not binary with xlc[6:0].

The crystal frequency adjustment can be used to compensate for crystal production tolerances. Utilizing the on-chip temperature sensor and suitable control software, the temperature dependency of the crystal can be canceled.

The typical value of the total on-chip capacitance C_{int} can be calculated as follows:

$$C_{int} = 1.8 \text{ pF} + 0.085 \text{ pF} \times \text{xlc}[6:0] + 3.7 \text{ pF} \times \text{xtalshift}$$

Note that the coarse shift bit xtalshift is not binary with xlc[6:0]. The total load capacitance C_{load} seen by the crystal can be calculated by adding the sum of all external parasitic PCB capacitances C_{ext} to C_{int}. If the maximum value of C_{int} (16.3 pF) is not sufficient, an external capacitor can be added for exact tuning. Additional information on calculating C_{ext} and crystal selection guidelines is provided in "AN417: Si4x3x Family Crystal Oscillator."

The crystal oscillator frequency is divided down internally and may be output to the microcontroller through one of the GPIO pins for use as the System Clock. In this fashion, only one crystal oscillator is required for the entire system and the BOM cost is reduced. The available clock frequencies and GPIO configuration are discussed further in "7.2. Microcontroller Clock" on page 40.

The Si4030/31/32 may also be driven with an external 30 MHz clock signal through the XOUT pin. When driving with an external reference or using a TCXO, the XTAL load capacitance register should be set to 0.

Add	R/W	Function/Description	D7	D6	D5	D4	D3	D2	D1	D0	POR Def.
09	R/W	Crystal Oscillator Load Capacitance	xtalshift	xlc[6]	xlc[5]	xlc[4]	xlc[3]	xlc[2]	xlc[1]	xlc[0]	40h

5.4. Regulators

There are a total of four regulators integrated onto the Si4030/31/32. With the exception of the digital regulator, all regulators are designed to operate with only internal decoupling. The digital regulator requires an external 1 μ F decoupling capacitor. All regulators are designed to operate with an input supply voltage from +1.8 to +3.6 V. The output stage of the of PA is not connected internally to a regulator and is connected directly to the battery voltage.

A supply voltage should only be connected to the VDD pins. No voltage should be forced on the digital regulator output.

6. Data Handling and Packet Handler

The internal modem is designed to operate with a packet including a 10101... preamble structure. To configure the modem to operate with packet formats without a preamble or other legacy packet structures contact customer support.

6.1. TX FIFO

A 64 byte FIFO is integrated into the chip for TX, as shown in Figure 11. "Register 7Fh. FIFO Access" is used to access the FIFO. A burst write, as described in "3.1. Serial Peripheral Interface (SPI)" on page 15, to address 7Fh will write data to the TX FIFO.

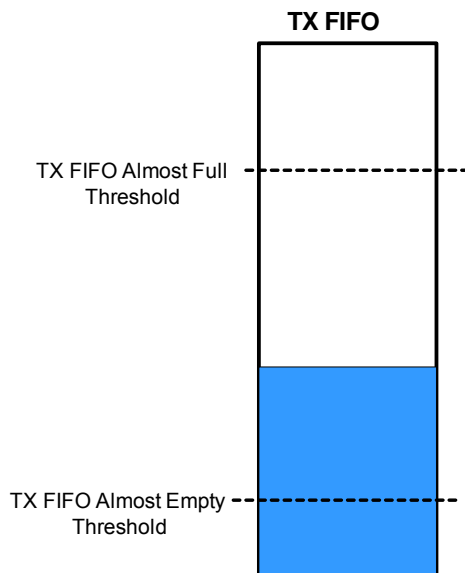

Figure 11. FIFO Threshold

The TX FIFO has two programmable thresholds. An interrupt event occurs when the data in the TX FIFO reaches these thresholds. The first threshold is the FIFO almost full threshold, $txafthr[5:0]$. The value in this register corresponds to the desired threshold value in number of bytes. When the data being filled into the TX FIFO crosses this threshold limit, an interrupt to the microcontroller is generated so the chip can enter TX mode to transmit the contents of the TX FIFO. The second threshold for TX is the FIFO almost empty Threshold, $txaethr[5:0]$. When the data being shifted out of the TX FIFO drops below the almost empty threshold an interrupt will be generated. The microcontroller will need to switch out of TX mode or fill more data into the TX FIFO. The transceiver can be configured so that when the TX FIFO is empty it will automatically exit the TX state and return to one of the low power states. When TX is initiated, it will transmit the number of bytes programmed into the packet length field (Reg 3Eh). When the packet ends, the chip will return to the state specified in register 07h. For example, if 08h is written to address 07h then the chip will return to the STANDBY state. If 09h is written then the chip will return to the READY state.

Add	R/W	Function/Description	D7	D6	D5	D4	D3	D2	D1	D0	POR Def.
08	R/W	Operating & Function Control 2	Reserved	Reserved	Reserved	Reserved	autotx	Reserved	Reserved	ffclrtx	00h
7C	R/W	TX FIFO Control 1	Reserved	Reserved	txafthr[5]	txafthr[4]	txafthr[3]	txafthr[2]	txafthr[1]	txafthr[0]	37h
7D	R/W	TX FIFO Control 2	Reserved	Reserved	txaethr[5]	txaethr[4]	txaethr[3]	txaethr[2]	txaethr[1]	txaethr[0]	04h

The TX FIFO may be cleared or reset with the ffclrtx bit in "Register 08h. Operating Mode and Function Control 2." All interrupts may be enabled by setting the Interrupt Enabled bits in "Register 05h. Interrupt Enable 1" and "Register 06h. Interrupt Enable 2," on page 59. If the interrupts are not enabled the function will not generate an interrupt on the nIRQ pin but the bits will still be read correctly in the Interrupt Status registers.

6.2. Packet Configuration

When using the FIFO, automatic packet handling may be enabled for the TX mode. "Register 30h. Data Access Control" through "Register 3Eh. Packet Length," on page 79 control the configuration for Packet Handling. The usual fields for network communication (such as preamble, synchronization word, headers, packet length, and CRC) can be configured to be automatically added to the data payload. The fields needed for packet generation normally change infrequently and can therefore be stored in registers. Automatically adding these fields to the data payload greatly reduces the amount of communication between the microcontroller and the Si4030/31/32 and reduces the required computational power of the microcontroller.

The general packet structure is shown in Figure 12. The length of each field is shown below the field. The preamble pattern is always a series of alternating ones and zeroes, starting with a zero. All the fields have programmable lengths to accommodate different applications. The most common CRC polynomials are available for selection.



Figure 12. Packet Structure

An overview of the packet handler configuration registers is shown in Table 12.

6.3. Packet Handler TX Mode

If the TX packet length is set the packet handler will send the number of bytes in the packet length field before returning to IDLE mode and asserting the packet sent interrupt. To resume sending data from the FIFO the microcontroller needs to command the chip to re-enter TX mode. Figure 14 provides an example transaction where the packet length is set to three bytes.



Figure 13. Multiple Packets in TX Packet Handler

Table 12. Packet Handler Registers

Add	R/W	Function/Description	D7	D6	D5	D4	D3	D2	D1	D0	POR Def.
30	R/W	Data Access Control	Reserved	lsbfrst	crcdonly	skip2ph	enpactx	encrc	crc[1]	crc[0]	8Dh
31	R	EzMAC status	0	Reserved	Reserved	Reserved	Reserved	Reserved	pktx	pkstent	—
32	Reserved										
33	R/W	Header Control 2	skipsyn	hdlen[2]	hdlen[1]	hdlen[0]	fixpklen	synclen[1]	synclen[0]	prealen[8]	22h
34	R/W	Preamble Length	prealen[7]	prealen[6]	prealen[5]	prealen[4]	prealen[3]	prealen[2]	prealen[1]	prealen[0]	08h
36	R/W	Sync Word 3	sync[31]	sync[30]	sync[29]	sync[28]	sync[27]	sync[26]	sync[25]	sync[24]	2Dh
37	R/W	Sync Word 2	sync[23]	sync[22]	sync[21]	sync[20]	sync[19]	sync[18]	sync[17]	sync[16]	D4h
38	R/W	Sync Word 1	sync[15]	sync[14]	sync[13]	sync[12]	sync[11]	sync[10]	sync[9]	sync[8]	00h
39	R/W	Sync Word 0	sync[7]	sync[6]	sync[5]	sync[4]	sync[3]	sync[2]	sync[1]	sync[0]	00h
3A	R/W	Transmit Header 3	txhd[31]	txhd[30]	txhd[29]	txhd[28]	txhd[27]	txhd[26]	txhd[25]	txhd[24]	00h
3B	R/W	Transmit Header 2	txhd[23]	txhd[22]	txhd[21]	txhd[20]	txhd[19]	txhd[18]	txhd[17]	txhd[16]	00h
3C	R/W	Transmit Header 1	txhd[15]	txhd[14]	txhd[13]	txhd[12]	txhd[11]	txhd[10]	txhd[9]	txhd[8]	00h
3D	R/W	Transmit Header 0	txhd[7]	txhd[6]	txhd[5]	txhd[4]	txhd[3]	txhd[2]	txhd[1]	txhd[0]	00h
3E	R/W	Transmit Packet Length	pklen[7]	pklen[6]	pklen[5]	pklen[4]	pklen[3]	pklen[2]	pklen[1]	pklen[0]	00h

6.4. Data Whitening, Manchester Encoding, and CRC

Data whitening can be used to avoid extended sequences of 0s or 1s in the transmitted data stream to achieve a more uniform spectrum. When enabled, the payload data bits are XORed with a pseudorandom sequence output from the built-in PN9 generator. The generator is initialized at the beginning of the payload. The receiver recovers the original data by repeating this operation. Manchester encoding can be used to ensure a dc-free transmission and good synchronization properties. When Manchester encoding is used, the effective datarate is unchanged but the actual datarate (preamble length, etc.) is doubled due to the nature of the encoding. The effective datarate when using Manchester encoding is limited to 128 kbps. The implementation of Manchester encoding is shown in Figure 15. Data whitening and Manchester encoding can be selected with "Register 70h. Modulation Mode Control 1". The CRC is configured via "Register 30h. Data Access Control". Figure 14 demonstrates the portions of the packet which have Manchester encoding, data whitening, and CRC applied. CRC can be applied to only the data portion of the packet or to the data, packet length and header fields. Figure 15 provides an example of how the Manchester encoding is done and also the use of the Manchester invert (enmaniv) function.



Figure 14. Operation of Data Whitening, Manchester Encoding, and CRC

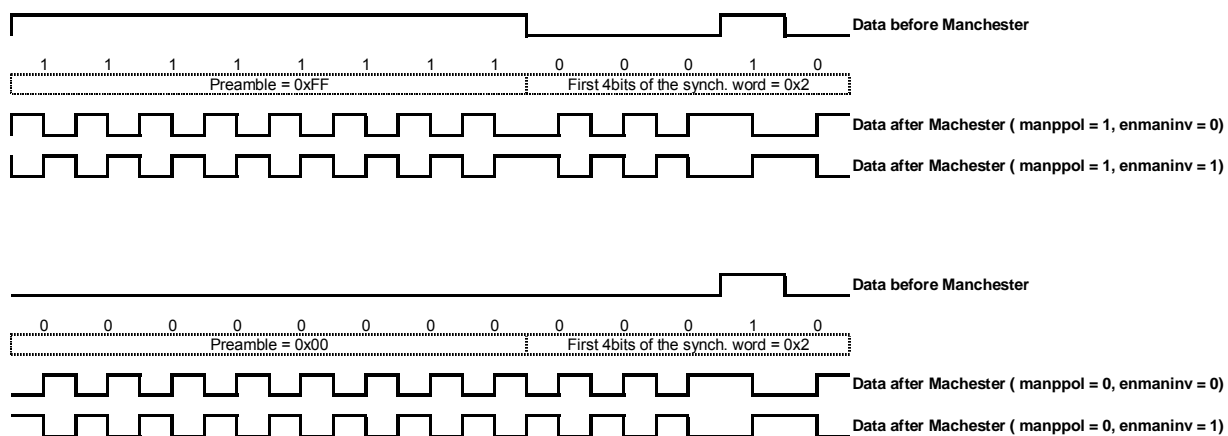

Figure 15. Manchester Coding Example

6.5. Synchronization Word Configuration

The synchronization word length can be configured in Reg 33h, `synclen[1:0]`. The expected or transmitted sync word can be configured from 1 to 4 bytes as defined below:

- `synclen[1:0] = 00`—Transmitted Synchronization Word (sync word) 3.
- `synclen[1:0] = 01`—Transmitted Synchronization Word 3 first, followed by sync word 2.
- `synclen[1:0] = 10`—Transmitted Synchronization Word 3 first, followed by sync word 2, followed by sync word 1.
- `synclen[1:0] = 11`—Transmitted Synchronization Word 3 first, followed by sync word 2, followed by sync word 1, followed by sync word 0.

The sync is transmitted in the following sequence: sync 3→sync 2→sync 1→sync 0. The sync word values can be programmed in Registers 36h–39h.

Si4030/31/32-B1

6.6. TX Retransmission and Auto TX

The Si4030/31/32 is capable of automatically retransmitting the last packet loaded in the TX FIFO. Automatic retransmission is set by entering the TX state with the txon bit without reloading the TX FIFO. This feature is useful for beacon transmission or when retransmission is required due to the absence of a valid acknowledgement. Only packets that fit completely in the TX FIFO can be automatically retransmitted.

An automatic transmission function is available, allowing the radio to automatically start or stop a transmission depending on the amount of data in the TX FIFO.

When autotx is set in "Register 08. Operating & Function Control 2," the transceiver will automatically enter the TX state when the TX FIFO almost full threshold is exceeded. Packets will be transmitted according to the configured packet length. To stop transmitting, clear the packet sent or TX FIFO almost empty interrupts must be cleared by reading register.

7. Auxiliary Functions

7.1. Smart Reset

The Si4030/31/32 contains an enhanced integrated SMART RESET or POR circuit. The POR circuit contains both a classic level threshold reset as well as a slope detector POR. This reset circuit was designed to produce a reliable reset signal under any circumstances. Reset will be initiated if any of the following conditions occur:

- Initial power on, VDD starts from gnd: reset is active till V_{DD} reaches V_{RR} (see table);
- When V_{DD} decreases below V_{LD} for any reason: reset is active till V_{DD} reaches V_{RR};
- A software reset via “Register 08h. Operating Mode and Function Control 2,” on page 61: reset is active for time T_{SWRST}
- V_{DD} glitch when the supply voltage exceeds the following time functioned limit:



Figure 16. POR Glitch Parameters

Table 13. POR Parameters

Parameter	Symbol	Comment	Min	Typ	Max	Unit
Release Reset Voltage	VRR		0.85	1.3	1.75	V
Power-On VDD Slope	SVDD	tested VDD slope region	0.03	—	300	V/ms
Low VDD Limit	VLD	VLD < VRR is guaranteed	0.7	1	1.3	V
Software Reset Pulse	TSWRST		50	—	470	μs
Threshold Voltage	VTSD		—	0.4	—	V
Reference Slope	k		—	0.2	—	V/ms
VDD Glitch Reset Pulse	TP	Also occurs after SDN, and initial power on	5	15	40	ms

The reset will initialize all registers to their default values. The reset signal is also available for output and use by the microcontroller by using the default setting for GPIO_0. The inverted reset signal is available by default on GPIO_1.

7.2. Microcontroller Clock

The 30 MHz crystal oscillator frequency is divided down internally and may be output to the microcontroller through GPIO2. This feature is useful to lower BOM cost by using only one crystal in the system. The system clock frequency is selectable from one of 8 options, as shown below. Except for the 32.768 kHz option, all other frequencies are derived by dividing the crystal oscillator frequency. The 32.768 kHz clock signal is derived from an internal RC oscillator or an external 32 kHz crystal. The default setting for GPIO2 is to output the microcontroller clock signal with a frequency of 1 MHz.

Add	R/W	Function/Description	D7	D6	D5	D4	D3	D2	D1	D0	POR Def.
0A	R/W	Microcontroller Output Clock			clkt[1]	clkt[0]	enlfc	mclk[2]	mclk[1]	mclk[0]	0Bh

mclk[2:0]	Clock Frequency
000	30 MHz
001	15 MHz
010	10 MHz
011	4 MHz
100	3 MHz
101	2 MHz
110	1 MHz
111	32.768 kHz

If the microcontroller clock option is being used there may be the need of a system clock for the microcontroller while the Si4030/31/32 is in SLEEP mode. Since the crystal oscillator is disabled in SLEEP mode in order to save current, the low-power 32.768 kHz clock can be automatically switched to become the microcontroller clock. This feature is called enable low frequency clock and is enabled by the enlfc bit in "Register 0Ah. Microcontroller Output Clock." When enlfc = 1 and the chip is in SLEEP mode then the 32.768 kHz clock will be provided to the microcontroller as the system clock, regardless of the setting of mclk[2:0]. For example, if mclk[2:0] = 000, 30 MHz will be provided through the GPIO output pin to the microcontroller as the system clock in all IDLE or TX states. When the chip enters SLEEP mode, the system clock will automatically switch to 32.768 kHz from the RC oscillator or 32.768 XTAL.

Another available feature for the microcontroller clock is the clock tail, clkt[1:0] in "Register 0Ah. Microcontroller Output Clock." If the low frequency clock feature is not enabled (enlfc = 0), then the system clock to the microcontroller is disabled in SLEEP mode. However, it may be useful to provide a few extra cycles for the microcontroller to complete its operation prior to the shutdown of the system clock signal. Setting the clkt[1:0] field will provide additional cycles of the system clock before it shuts off.

clkt[1:0]	Clock Tail
00	0 cycles
01	128 cycles
10	256 cycles
11	512 cycles

If an interrupt is triggered, the microcontroller clock will remain enabled regardless of the selected mode. As soon as the interrupt is read the state machine will then move to the selected mode. The minimum current consumption will not be achieved until the interrupt is read. For instance, if the chip is commanded to SLEEP mode but an interrupt has occurred the 30 MHz XTAL will not be disabled until the interrupt has been cleared.

7.3. General Purpose ADC

An 8-bit SAR ADC is integrated for general purpose use, as well as for digitizing the on-chip temperature sensor reading. Registers 0Fh "ADC Configuration", 10h "Sensor Offset" and 4Fh "Amplifier Offset" can be used to configure the ADC operation. Details of these registers are on pages 67 and 68, respectively.

Every time an ADC conversion is desired, bit 7 "adcstart/adcbusy" in "Register 1Fh. Clock Recovery Gearshift Override" must be set to 1. This is a self clearing bit that will be reset to 0 at the end of the conversion cycle of the ADC. The conversion time for the ADC is 350 μ s. After this time or when the "adcstart/adcbusy" bit is cleared, then the ADC value may be read out of "Register 11h. ADC Value."

The architecture of the ADC is shown in Figure 17. The signal and reference inputs of the ADC are selected by `adcsel[2:0]` and `adcref[1:0]` in register 0Fh "ADC Configuration", respectively. The default setting is to read out the temperature sensor using the bandgap voltage (VBG) as reference. With the VBG reference the input range of the ADC is from 0-1.02 V with an LSB resolution of 4 mV (1.02/255). Changing the ADC reference will change the LSB resolution accordingly.

A differential multiplexer and amplifier are provided for interfacing external bridge sensors. The gain of the amplifier is selectable by `adcgain[1:0]` in Register 0Fh. The majority of sensor bridges have supply voltage (V_{DD}) dependent gain and offset. The reference voltage of the ADC can be changed to either $V_{DD}/2$ or $V_{DD}/3$. A programmable V_{DD} dependent offset voltage can be added using `soffs[3:0]` in register 10h.

See "AN448: General Purpose ADC Configuration" for more details on the usage of the general purpose ADC.



Figure 17. General Purpose ADC Architecture

Add	R/W	Function/Description	D7	D6	D5	D4	D3	D2	D1	D0	POR Def.
0F	R/W	ADC Configuration	adcstart/adcbusy	adcsel[2]	adcsel[1]	adcsel[0]	adcref[1]	adcref[0]	adcgain[1]	adcgain[0]	00h
10	R/W	Sensor Offset					soffs[3]	soffs[2]	soffs[1]	soffs[0]	00h
11	R	ADC Value	adc[7]	adc[6]	adc[5]	adc[4]	adc[3]	adc[2]	adc[1]	adc[0]	—

7.4. Temperature Sensor

An integrated on-chip analog temperature sensor is available. The temperature sensor will be automatically enabled when the temperature sensor is selected as the input of the ADC or when the analog temp voltage is selected on the analog test bus. The temperature sensor value may be digitized using the general-purpose ADC and read out over the SPI through "Register 10h. ADC Sensor Amplifier Offset." The range of the temperature sensor is configurable. Table 14 lists the settings for the different temperature ranges and performance.

To use the Temp Sensor:

1. Set the input for ADC to the temperature sensor, "Register 0Fh. ADC Configuration"—`adcsel[2:0] = 000`
2. Set the reference for ADC, "Register 0Fh. ADC Configuration"—`adcref[1:0] = 00`
3. Set the temperature range for ADC, "Register 12h. Temperature Sensor Calibration"—`tstrange[1:0]`
4. Set `entsoffs = 1`, "Register 12h. Temperature Sensor Calibration"
5. Trigger ADC reading, "Register 0Fh. ADC Configuration"—`adcstart = 1`
6. Read temperature value—Read contents of "Register 11h. ADC Value"

Add	R/W	Function/Description	D7	D6	D5	D4	D3	D2	D1	D0	POR Def.
12	R/W	Temperature Sensor Control	<code>tstrange[1]</code>	<code>tstrange[0]</code>	<code>entsoffs</code>	<code>entstrim</code>	<code>tstrim[3]</code>	<code>tstrim[2]</code>	<code>vbgtrim[1]</code>	<code>vbgtrim[0]</code>	20h
13	R/W	Temperature Value Offset	<code>tvoffs[7]</code>	<code>tvoffs[6]</code>	<code>tvoffs[5]</code>	<code>tvoffs[4]</code>	<code>tvoffs[3]</code>	<code>tvoffs[2]</code>	<code>tvoffs[1]</code>	<code>tvoffs[0]</code>	00h

Table 14. Temperature Sensor Range

<code>entoff</code>	<code>tstrange[1]</code>	<code>tstrange[0]</code>	Temp. range	Unit	Slope	ADC8 LSB
1	0	0	-64 ... 64	°C	8 mV/°C	0.5 °C
1	0	1	-64 ... 192	°C	4 mV/°C	1 °C
1	1	0	0 ... 128	°C	8 mV/°C	0.5 °C
1	1	1	-40 ... 216	°F	4 mV/°F	1 °F
0*	1	0	0 ... 341	°K	3 mV/°K	1.333 °K

***Note:** Absolute temperature mode, no temperature shift. This mode is only for test purposes. POR value of `EN_TOFF` is 1.

The slope of the temperature sensor is very linear and monotonic. For absolute accuracy better than 10 °C calibration is necessary. The temperature sensor may be calibrated by setting `entsoffs = 1` in "Register 12h. Temperature Sensor Control" and setting the offset with the `tvoffs[7:0]` bits in "Register 13h. Temperature Value Offset." This method adds a positive offset digitally to the ADC value that is read in "Register 11h. ADC Value." The other method of calibration is to use the `tstrim` which compensates the analog circuit. This is done by setting `entstrim = 1` and using the `tstrim[2:0]` bits to offset the temperature in "Register 12h. Temperature Sensor Control." With this method of calibration, a negative offset may be achieved. With both methods of calibration better than ±3 °C absolute accuracy may be achieved.

The different ranges for the temperature sensor and ADC8 are demonstrated in Figure 18. The value of the ADC8 may be translated to a temperature reading by $ADC8Value \times ADC8\ LSB + \text{Lowest Temperature in Temp Range}$. For instance for a `tstrange = 00`, $Temp = ADC8Value \times 0.5 - 64$.



Figure 18. Temperature Ranges using ADC8

7.5. Low Battery Detector

A low battery detector (LBD) with digital read-out is integrated into the chip. A digital threshold may be programmed into the lbd[4:0] field in "Register 1Ah. Low Battery Detector Threshold." When the digitized battery voltage reaches this threshold an interrupt will be generated on the nIRQ pin to the microcontroller. The microcontroller can confirm source of the interrupt by reading "Register 03h. Interrupt/Status 1" and "Register 04h. Interrupt/Status 2," on page 56.

If the LBD is enabled while the chip is in SLEEP mode, it will automatically enable the RC oscillator which will periodically turn on the LBD circuit to measure the battery voltage. The battery voltage may also be read out through "Register 1Bh. Battery Voltage Level" at any time when the LBD is enabled. The low battery detect function is enabled by setting enlbd=1 in "Register 07h. Operating Mode and Function Control 1".

Ad	R/W	Function/Description	D7	D6	D5	D4	D3	D2	D1	D0	POR Def.
1A	R/W	Low Battery Detector Threshold				lbd[4]	lbd[3]	lbd[2]	lbd[1]	lbd[0]	14h
1B	R	Battery Voltage Level	0	0	0	vbat[4]	vbat[3]	vbat[2]	vbat[1]	vbat[0]	—

The LBD output is digitized by a 5-bit ADC. When the LBD function is enabled, enlbd = 1 in "Register 07h. Operating Mode and Function Control 1", the battery voltage may be read at anytime by reading "Register 1Bh. Battery Voltage Level." A battery voltage threshold may be programmed in "Register 1Ah. Low Battery Detector Threshold." When the battery voltage level drops below the battery voltage threshold an interrupt will be generated on the nIRQ pin to the microcontroller if the LBD interrupt is enabled in "Register 06h. Interrupt Enable 2," on page 59. The microcontroller will then need to verify the interrupt by reading the interrupt status register, addresses 03 and 04h. The LSB step size for the LBD ADC is 50 mV, with the ADC range demonstrated in the table below. If the LBD is enabled the LBD and ADC will automatically be enabled every 1 s for approximately 250 μs to measure the voltage which minimizes the current consumption in Sensor mode. Before an interrupt is activated four consecutive readings are required.

$$\text{BatteryVoltage} = 1.7 + 50\text{mV} \times \text{ADCValue}$$

ADC Value	VDD Voltage [V]
0	< 1.7
1	1.7–1.75
2	1.75–1.8
...	...
29	3.1–3.15
30	3.15–3.2
31	> 3.2

7.6. Wake-Up Timer

The chip contains an integrated wake-up timer which can be used to periodically wake the chip from SLEEP mode. The wake-up timer runs from the internal 32.768 kHz RC Oscillator. The wake-up timer can be configured to run when in SLEEP mode. If `enwt = 1` in "Register 07h. Operating Mode and Function Control 1" when entering SLEEP mode, the wake-up timer will count for a time specified defined in Registers 14–16h, "Wake Up Timer Period." At the expiration of this period an interrupt will be generated on the nIRQ pin if this interrupt is enabled. The microcontroller will then need to verify the interrupt by reading the Registers 03h–04h, "Interrupt Status 1 & 2". The wake-up timer value may be read at any time by the `wtv[15:0]` read only registers 13h–14h.

The formula for calculating the Wake-Up Period is the following:

$$WUT = \frac{4 \times M \times 2^R}{32.768} ms$$

WUT Register	Description
<code>wtr[3:0]</code>	R Value in Formula
<code>wtd[1:0]</code>	D Value in Formula
<code>wtm[15:0]</code>	M Value in Formula

Use of the D variable in the formula is only necessary if finer resolution is required than can be achieved by using the R value.

Add	R/W	Function/Description	D7	D6	D5	D4	D3	D2	D1	D0	POR Def.
14	R/W	Wake-Up Timer Period 1			<code>wtr[3]</code>	<code>wtr[2]</code>	<code>wtr[1]</code>	<code>wtr[0]</code>	<code>wtd[1]</code>	<code>wtd[0]</code>	00h
15	R/W	Wake-Up Timer Period 2	<code>wtm[15]</code>	<code>wtm[14]</code>	<code>wtm[13]</code>	<code>wtm[12]</code>	<code>wtm[11]</code>	<code>wtm[10]</code>	<code>wtm[9]</code>	<code>wtm[8]</code>	00h
16	R/W	Wake-Up Timer Period 3	<code>wtm[7]</code>	<code>wtm[6]</code>	<code>wtm[5]</code>	<code>wtm[4]</code>	<code>wtm[3]</code>	<code>wtm[2]</code>	<code>wtm[1]</code>	<code>wtm[0]</code>	00h
17	R	Wake-Up Timer Value 1	<code>wtv[15]</code>	<code>wtv[14]</code>	<code>wtv[13]</code>	<code>wtv[12]</code>	<code>wtv[11]</code>	<code>wtv[10]</code>	<code>wtv[9]</code>	<code>wtv[8]</code>	—
18	R	Wake-Up Timer Value 2	<code>wtv[7]</code>	<code>wtv[6]</code>	<code>wtv[5]</code>	<code>wtv[4]</code>	<code>wtv[3]</code>	<code>wtv[2]</code>	<code>wtv[1]</code>	<code>wtv[0]</code>	—

There are two different methods for utilizing the wake-up timer (WUT) depending on if the WUT interrupt is enabled in "Register 06h. Interrupt Enable 2," on page 59. If the WUT interrupt is enabled then nIRQ pin will go low when the timer expires. The chip will also change state so that the 30 MHz XTAL is enabled so that the microcontroller clock output is available for the microcontroller to use to process the interrupt. The other method of use is to not enable the WUT interrupt and use the WUT GPIO setting. In this mode of operation the chip will not change state until commanded by the microcontroller. The different modes of operating the WUT and the current consumption impacts are demonstrated in Figure 19.

A 32 kHz XTAL may also be used for better timing accuracy. By setting the `x32 ksel` bit in "Register 07h. Operating & Function Control 1," GPIO0 is automatically reconfigured so that an external 32 kHz XTAL may be connected to this pin. In this mode, the GPIO0 is extremely sensitive to parasitic capacitance, so only the XTAL should be connected to this pin with the XTAL physically located as close to the pin as possible. Once the `x32 ksel` bit is set, all internal functions such as WUT, microcontroller clock, and LDC mode will use the 32 kHz XTAL and not the 32 kHz RC oscillator.

Interrupt Enable enwut = 1 (Reg 06h)

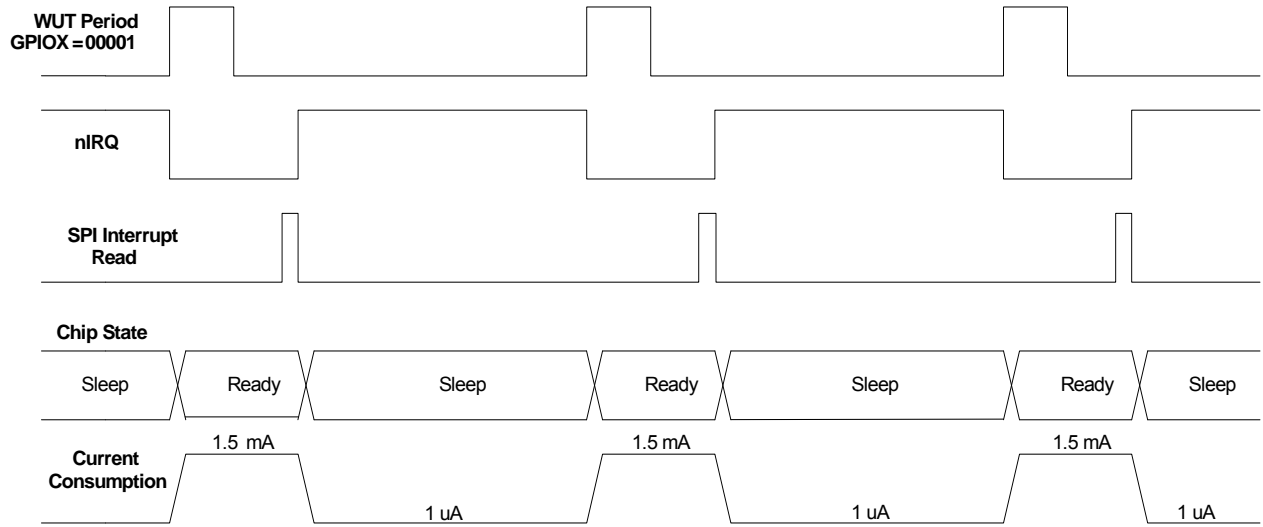

Interrupt Enable enwut = 0 (Reg 06h)

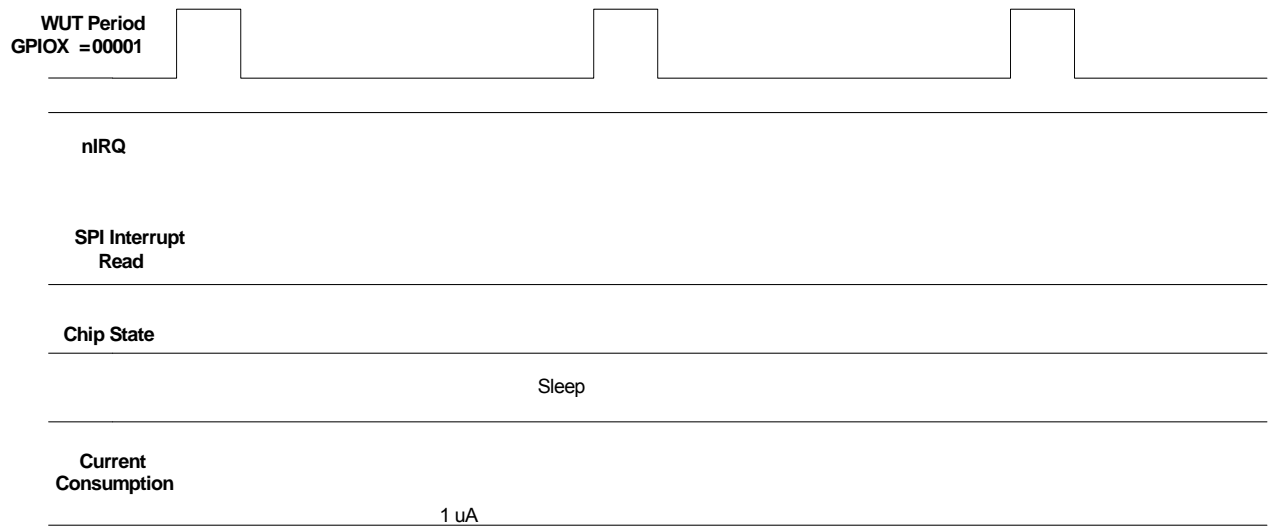

Figure 19. WUT Interrupt and WUT Operation

7.7. GPIO Configuration

Three general purpose IOs (GPIOs) are available. Numerous functions such as specific interrupts, TRSW control, Microcontroller Output, etc. can be routed to the GPIO pins as shown in the tables below. When in Shutdown mode all the GPIO pads are pulled low.

Note: The ADC should not be selected as an input to the GPIO in Standby or Sleep Modes and will cause excess current consumption.

Add	R/W	Function/Description	D7	D6	D5	D4	D3	D2	D1	D0	POR Def.
0B	R/W	GPIO0 Configuration	gpio0drv[1]	gpio0drv[0]	pup0	gpio0[4]	gpio0[3]	gpio0[2]	gpio0[1]	gpio0[0]	00h
0C	R/W	GPIO1 Configuration	gpio1drv[1]	gpio1drv[0]	pup1	gpio1[4]	gpio1[3]	gpio1[2]	gpio1[1]	gpio1[0]	00h
0D	R/W	GPIO2 Configuration	gpio2drv[1]	gpio2drv[0]	pup2	gpio2[4]	gpio2[3]	gpio2[2]	gpio2[1]	gpio2[0]	00h
0E	R/W	I/O Port Configuration		extitst[2]	extitst[1]	extitst[0]	itsdo	dio2	dio1	dio0	00h

The GPIO settings for GPIO1 and GPIO2 are the same as for GPIO0 with the exception of the 00000 default setting. The default settings for each GPIO are listed below:

GPIO	00000—Default Setting
GPIO0	POR
GPIO1	POR Inverted
GPIO2	Microcontroller Clock

For a complete list of the available GPIO's see "AN466: Si4430/31/32 Register Descriptions."

The GPIO drive strength may be adjusted with the gpioXdrv[1:0] bits. Setting a higher value will increase the drive strength and current capability of the GPIO by changing the driver size. Special care should be taken in setting the drive strength and loading on GPIO2 when the microcontroller clock is used. Excess loading or inadequate drive may contribute to increased spurious emissions.

9. Application Notes and Reference Designs

A comprehensive set of application notes and reference designs are available to assist with the development of a radio system. A partial list of applications notes is given below.

For the complete list of application notes, latest reference designs and demos visit the [Silicon Labs website](#).

- AN361: Wireless MBUS Implementation using EZRadioPRO Devices
- AN379: Antenna Diversity with EZRadioPRO
- AN414: EZRadioPRO Layout Design Guide
- AN415: EZRadioPRO Programming Guide
- AN417: Si4x3x Family Crystal Oscillators
- AN419: ARIB STD-T67 Narrow-Band 426/429 MHz Measured on the Si4431-A0
- AN427: EZRadioPRO Si433x and Si443x RX LNA Matching
- AN429: Using the DC-DC Converter on the F9xx Series MCU for Single Battery Operation with the EZRadioPRO RF Devices
- AN432: RX BER Measurement on EZRadioPRO with a Looped PN Sequence
- AN435: Si4032/4432 PA Matching
- AN436: Si4030/4031/4430/4431 PA Matching
- AN437: 915 MHz Measurement Results and FCC Compliance
- AN439: EZRadioPRO Quick Start Guide
- AN440: Si4430/31/32 Detailed Register Descriptions
- AN445: Si4431 RF Performance and ETSI Compliance Test Results
- AN448: General Purpose ADC Configuration
- AN453: Using the EZRadioPRO Calculator and Advanced RX BW Calculations and Settings
- AN459: 950 MHz Measurement Results and ARIB Compliance
- AN460: 470 MHz Measurement Results for China
- AN461: +24 dBm External PA Application Note and Reference Design
- AN462: Extended battery life using the EZRadioPRO and a DC-DC Buck Converter
- AN463: Support for Non-Standard Packet Structures and RAW Mode
- AN466: Si4030/31/32 Register Descriptions
- AN467: Si4330 Register Descriptions

10. Customer Support

Technical support for the complete family of Silicon Labs wireless products is available by accessing the wireless section of the Silicon Labs' website at www.silabs.com/wireless. For answers to common questions please visit the wireless knowledge base at www.silabs.com/support/knowledgebase.

Si4030/31/32-B1

11. Register Table and Descriptions

Table 15. Register Descriptions

Add	R/W	Function/Desc	Data								POR Default
			D7	D6	D5	D4	D3	D2	D1	D0	
01	R	Device Version	0	0	0	vc[4]	vc[3]	vc[2]	vc[1]	vc[0]	06h
02	R	Device Status	ffovfl	ffunfl		Reserved	reserved	reserved	cps[1]	cps[0]	—
03	R	Interrupt Status 1	ifferr	itxffaull	itxffaem	Reserved	ixext	ipksent	Reserved	Reserved	—
04	R	Interrupt Status 2	Reserved	Reserved	Reserved	Reserved	iwut	ilbd	ichiprpy	ipor	—
05	R/W	Interrupt Enable 1	enfferr	entxffaull	entxffaem	Reserved	enext	enpkent	Reserved	Reserved	00h
06	R/W	Interrupt Enable 2	Reserved	Reserved	Reserved	Reserved	enwut	enlbd	enchiprpy	enpor	03h
07	R/W	Operating & Function Control 1	swres	enlbd	enwt	x32ksel	txon	Reserved	pllcn	xtcn	01h
08	R/W	Operating & Function Control 2	Reserved	Reserved	Reserved	Reserved	autotx	enldm	Reserved	ffclrtx	00h
09	R/W	Crystal Oscillator Load Capacitance	xtalshft	xlcl[6]	xlcl[5]	xlcl[4]	xlcl[3]	xlcl[2]	xlcl[1]	xlcl[0]	7Fh
0A	R/W	Microcontroller Output Clock	Reserved	Reserved	clkt[1]	clkt[0]	enlfc	mclcl[2]	mclcl[1]	mclcl[0]	06h
0B	R/W	GPIO0 Configuration	gpio0drv[1]	gpio0drv[0]	pup0	gpio0[4]	gpio0[3]	gpio0[2]	gpio0[1]	gpio0[0]	00h
0C	R/W	GPIO1 Configuration	gpio1drv[1]	gpio1drv[0]	pup1	gpio1[4]	gpio1[3]	gpio1[2]	gpio1[1]	gpio1[0]	00h
0D	R/W	GPIO2 Configuration	gpio2drv[1]	gpio2drv[0]	pup2	gpio2[4]	gpio2[3]	gpio2[2]	gpio2[1]	gpio2[0]	00h
0E	R/W	I/O Port Configuration	Reserved	extitst[2]	extitst[1]	extitst[0]	itsdo	dio2	dio1	dio0	00h
0F	R/W	ADC Configuration	adcstart/adc-done	adcsel[2]	adcsel[1]	adcsel[0]	adcref[1]	adcref[0]	adcgain[1]	adcgain[0]	00h
10	R/W	ADC Sensor Amplifier Offset	Reserved	Reserved	Reserved	Reserved	adcoffs[3]	adcoffs[2]	adcoffs[1]	adcoffs[0]	00h
11	R	ADC Value	adc[7]	adc[6]	adc[5]	adc[4]	adc[3]	adc[2]	adc[1]	adc[0]	—
12	R/W	Temperature Sensor Control	tsrange[1]	tsrange[0]	entsoffs	entstrim	tstrim[3]	tstrim[2]	tstrim[1]	tstrim[0]	20h
13	R/W	Temperature Value Offset	tvoffs[7]	tvoffs[6]	tvoffs[5]	tvoffs[4]	tvoffs[3]	tvoffs[2]	tvoffs[1]	tvoffs[0]	00h
14	R/W	Wake-Up Timer Period 1	Reserved	Reserved	Reserved	wtr[4]	wtr[3]	wtr[2]	wtr[1]	wtr[0]	03h
15	R/W	Wake-Up Timer Period 2	wtm[15]	wtm[14]	wtm[13]	wtm[12]	wtm[11]	wtm[10]	wtm[9]	wtm[8]	00h
16	R/W	Wake-Up Timer Period 3	wtm[7]	wtm[6]	wtm[5]	wtm[4]	wtm[3]	wtm[2]	wtm[1]	wtm[0]	01h
17	R	Wake-Up Timer Value 1	wtv[15]	wtv[14]	wtv[13]	wtv[12]	wtv[11]	wtv[10]	wtv[9]	wtv[8]	—
18	R	Wake-Up Timer Value 2	wtv[7]	wtv[6]	wtv[5]	wtv[4]	wtv[3]	wtv[2]	wtv[1]	wtv[0]	—
19			Reserved								
1A	R/W	Low Battery Detector Threshold	Reserved	Reserved	Reserved	lbd[4]	lbd[3]	lbd[2]	lbd[1]	lbd[0]	14h
1B	R	Battery Voltage Level	0	0	0	vbat[4]	vbat[3]	vbat[2]	vbat[1]	vbat[0]	—
1C-2F			Reserved								
30	R/W	Data Access Control	Reserved	lsbrst	crdonly	Reserved	enpactx	enrc	crc[1]	crc[0]	8Dh
31	R	EzMAC status	0	Reserved	Reserved	Reserved	Reserved	Reserved	pktx	pkstent	—
32			Reserved								
33	R/W	Header Control 2	Reserved	hdlcn[2]	hdlcn[1]	hdlcn[0]	fixpklen	syncncln[1]	syncncln[0]	prealcn[8]	22h
34	R/W	Preamble Length	prealcn[7]	prealcn[6]	prealcn[5]	prealcn[4]	prealcn[3]	prealcn[2]	prealcn[1]	prealcn[0]	08h
36	R/W	Sync Word 3	sync[31]	sync[30]	sync[29]	sync[28]	sync[27]	sync[26]	sync[25]	sync[24]	2Dh
37	R/W	Sync Word 2	sync[23]	sync[22]	sync[21]	sync[20]	sync[19]	sync[18]	sync[17]	sync[16]	D4h
38	R/W	Sync Word 1	sync[15]	sync[14]	sync[13]	sync[12]	sync[11]	sync[10]	sync[9]	sync[8]	00h
39	R/W	Sync Word 0	sync[7]	sync[6]	sync[5]	sync[4]	sync[3]	sync[2]	sync[1]	sync[0]	00h
3A	R/W	Transmit Header 3	txhd[31]	txhd[30]	txhd[29]	txhd[28]	txhd[27]	txhd[26]	txhd[25]	txhd[24]	00h
3B	R/W	Transmit Header 2	txhd[23]	txhd[22]	txhd[21]	txhd[20]	txhd[19]	txhd[18]	txhd[17]	txhd[16]	00h
3C	R/W	Transmit Header 1	txhd[15]	txhd[14]	txhd[13]	txhd[12]	txhd[11]	txhd[10]	txhd[9]	txhd[8]	00h
3D	R/W	Transmit Header 0	txhd[7]	txhd[6]	txhd[5]	txhd[4]	txhd[3]	txhd[2]	txhd[1]	txhd[0]	00h
3E	R/W	Transmit Packet Length	pklen[7]	pklen[6]	pklen[5]	pklen[4]	pklen[3]	pklen[2]	pklen[1]	pklen[0]	00h
4F	R/W	ADC8 Control	Reserved	Reserved	adc8[5]	adc8[4]	adc8[3]	adc8[2]	adc8[1]	adc8[0]	10h
60			Reserved								
62	R/W	Crystal Oscillator/Control Test	pwst[2]	pwst[1]	pwst[0]	clkhyst	enbias2x	enamp2x	bufovr	enbuf	24h
6D	R/W	TX Power	papeakval	papeaken	papeakvl[1]	papeakvl[0]	lna_sw	txpow[2]	txpow[1]	txpow[0]	18h
6E	R/W	TX Data Rate 1	txdr[15]	txdr[14]	txdr[13]	txdr[12]	txdr[11]	txdr[10]	txdr[9]	txdr[8]	0Ah
6F	R/W	TX Data Rate 0	txdr[7]	txdr[6]	txdr[5]	txdr[4]	txdr[3]	txdr[2]	txdr[1]	txdr[0]	3Dh
70	R/W	Modulation Mode Control 1	Reserved	Reserved	txdtrscale	enphwpdn	manppol	enmaninv	enmanch	enwhite	0Ch
71	R/W	Modulation Mode Control 2	trclk[1]	trclk[0]	dtmod[1]	dtmod[0]	eninv	fd[8]	modtyp[1]	modtyp[0]	00h
72	R/W	Frequency Deviation	fd[7]	fd[6]	fd[5]	fd[4]	fd[3]	fd[2]	fd[1]	fd[0]	20h
73	R/W	Frequency Offset 1	fo[7]	fo[6]	fo[5]	fo[4]	fo[3]	fo[2]	fo[1]	fo[0]	00h
74	R/W	Frequency Offset 2	Reserved	Reserved	Reserved	Reserved	Reserved	Reserved	fo[9]	fo[8]	00h
75	R/W	Frequency Band Select	Reserved	sbsel	hbsel	fb[4]	fb[3]	fb[2]	fb[1]	fb[0]	75h
76	R/W	Nominal Carrier Frequency 1	fc[15]	fc[14]	fc[13]	fc[12]	fc[11]	fc[10]	fc[9]	fc[8]	BBh
77	R/W	Nominal Carrier Frequency 0	fc[7]	fc[6]	fc[5]	fc[4]	fc[3]	fc[2]	fc[1]	fc[0]	80h
79	R/W	Frequency Hopping Channel Select	fhch[7]	fhch[6]	fhch[5]	fhch[4]	fhch[3]	fhch[2]	fhch[1]	fhch[0]	00h
7A	R/W	Frequency Hopping Step Size	fhs[7]	fhs[6]	fhs[5]	fhs[4]	fhs[3]	fhs[2]	fhs[1]	fhs[0]	00h
7C	R/W	TX FIFO Control 1	Reserved	Reserved	txafthr[5]	txafthr[4]	txafthr[3]	txafthr[2]	txafthr[1]	txafthr[0]	37h
7D	R/W	TX FIFO Control 2	Reserved	Reserved	txaethr[5]	txaethr[4]	txaethr[3]	txaethr[2]	txaethr[1]	txaethr[0]	04h
7E			Reserved								
7F	R/W	FIFO Access	fifod[7]	fifod[6]	fifod[5]	fifod[4]	fifod[3]	fifod[2]	fifod[1]	fifod[0]	—

Note: Detailed register descriptions are available in “AN466: Si4030/31/32 Register Descriptions.”

12. Pin Descriptions: Si4030/31/32



Pin	Pin Name	I/O	Description
1	VDD_RF	VDD	+1.8 to +3.6 V supply voltage input to all analog +1.7 V regulators. The recommended V_{DD} supply voltage is +3.3 V.
2	TX	O	Transmit output pin. The PA output is an open-drain connection so the L-C match must supply VDD (+3.3 VDC nominal) to this pin.
3–6	NC	—	No Connect.
7	GPIO_0	I/O	General Purpose Digital I/O that may be configured through the registers to perform various functions including: Microcontroller Clock Output, FIFO status, POR, Wake-Up timer, Low Battery Detect, TRSW, AntDiversity control, etc. See the SPI GPIO Configuration Registers, Address 0Bh, 0Ch, and 0Dh for more information.
8	GPIO_1	I/O	
9	GPIO_2	I/O	
10	VR_DIG	O	Regulated Output Voltage of the Digital 1.7 V Regulator. A 1 μ F decoupling capacitor is required.
11	NC	—	Internally this pin is tied to the paddle of the package. This pin should be left unconnected or connected to GND only.
12	VDD_DIG	VDD	+1.8 to +3.6 V supply voltage input to the Digital +1.7 V Regulator. The recommended V_{DD} supply voltage is +3.3 V.
13	SDO	O	0– V_{DD} V digital output that provides a serial readback function of the internal control registers.
14	SDI	I	Serial Data input. 0– V_{DD} V digital input. This pin provides the serial data stream for the 4-line serial data bus.
15	SCLK	I	Serial Clock input. 0– V_{DD} V digital input. This pin provides the serial data clock function for the 4-line serial data bus. Data is clocked into the Si4030/31/32 on positive edge transitions.
16	nSEL	I	Serial Interface Select input. 0– V_{DD} V digital input. This pin provides the Select/Enable function for the 4-line serial data bus. The signal is also used to signify burst read/write mode.
17	nIRQ	O	General Microcontroller Interrupt Status output. When the Si4030/31/32 exhibits anyone of the Interrupt Events the nIRQ pin will be set low=0. Please see the Control Logic registers section for more information on the Interrupt Events. The Microcontroller can then determine the state of the interrupt by reading a corresponding SPI Interrupt Status Registers, Address 03h and 04h. No external resistor pull-up is required, but it may be desirable if multiple interrupt lines are connected.
18	XOUT	O	Crystal Oscillator Output. Connect to an external 30 MHz crystal or to an external source. If using an external source with no crystal then dc coupling with a nominal 0.8 VDC level is recommended with a minimum amplitude of 700 mVpp.
19	XIN	I	Crystal Oscillator Input. Connect to an external 30 MHz crystal or leave floating when driving with an external source on XOUT.
20	SDN	I	Shutdown input pin. 0– V_{DD} V digital input. SDN should be = 0 in all modes except Shutdown mode. When SDN =1 the chip will be completely shutdown and the contents of the registers will be lost.
PKG	PADDLE_GND	GND	The exposed metal paddle on the bottom of the Si4030/31/32 supplies the RF and circuit ground(s) for the entire chip. It is very important that a good solder connection is made between this exposed metal paddle and the ground plane of the PCB underlying the Si4030/31/32.

13. Ordering Information

Part Number*	Description	Package Type	Operating Temperature
Si4030-B1-FM	ISM EZRadioPRO Transmitter	QFN-20 Pb-free	-40 to 85 °C
Si4031-B1-FM	ISM EZRadioPRO Transmitter	QFN-20 Pb-free	-40 to 85 °C
Si4032-B1-FM	ISM EZRadioPRO Transmitter	QFN-20 Pb-free	-40 to 85 °C

***Note:** Add an "(R)" at the end of the device part number to denote tape and reel option; 2500 quantity per reel.

14. Package Markings (Top Marks)

14.1. Si4030/31/32 Top Mark

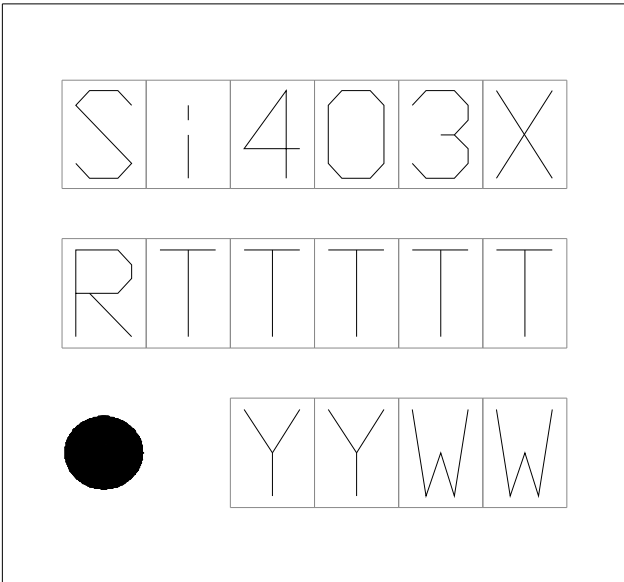

14.2. Top Mark Explanation

Mark Method:	YAG Laser	
Line 1 Marking:	X = Part Number	0 = Si4030 1 = Si4031 2 = Si4032
Line 2 Marking:	R = Die Revision	B = Revision B1
	TTTTT = Internal Code	Internal tracking code.
Line 3 Marking:	YY= Year WW = Workweek	Assigned by the Assembly House. Corresponds to the last significant digit of the year and workweek of the mold date.

Si4030/31/32-B1

15. Package Outline: Si4030/31/32

Figure 21 illustrates the package details for the Si4030/31/32. Table 16 lists the values for the dimensions shown in the illustration.

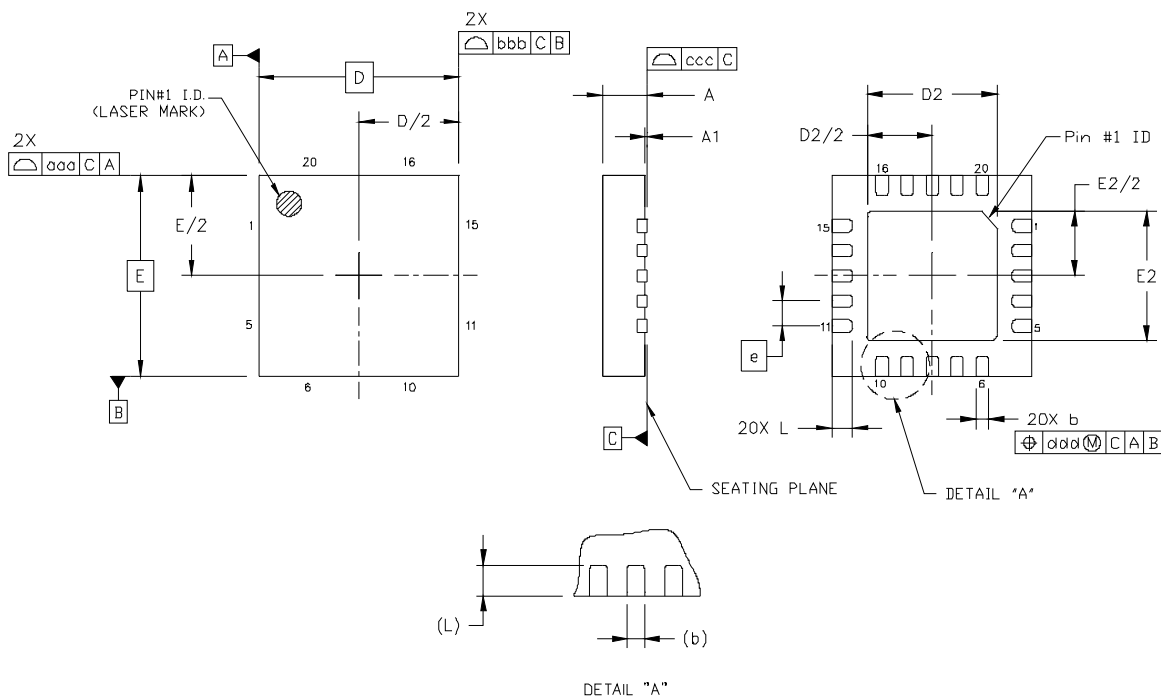

Figure 21. 20-Pin Quad Flat No-Lead (QFN)

Table 16. Package Dimensions

Symbol	Millimeters		
	Min	Nom	Max
A	0.80	0.85	0.90
A1	0.00	0.02	0.05
b	0.18	0.25	0.30
D	4.00 BSC		
D2	2.55	2.60	2.65
e	0.50 BSC		
E	4.00 BSC		
E2	2.50	2.60	2.70
L	0.30	0.40	0.50
aaa	—	—	0.10
bbb	—	—	0.10
ccc	—	—	0.08
ddd	—	—	0.10
eee	—	—	0.10

Notes:

1. All dimensions are shown in millimeters (mm) unless otherwise noted.
2. Dimensioning and tolerancing per ANSI Y14.5M-1994.
3. This drawing conforms to the JEDEC Solid State Outline MO-220, Variation VGGD-8.
4. Recommended card reflow profile is per the JEDEC/IPC J-STD-020 specification for Small Body Components.

16. PCB Land Pattern: Si4030/31/32

Figure 22 illustrates the PCB land pattern details for the Si4030/31/32. Table 17 lists the values for the dimensions shown in the illustration.

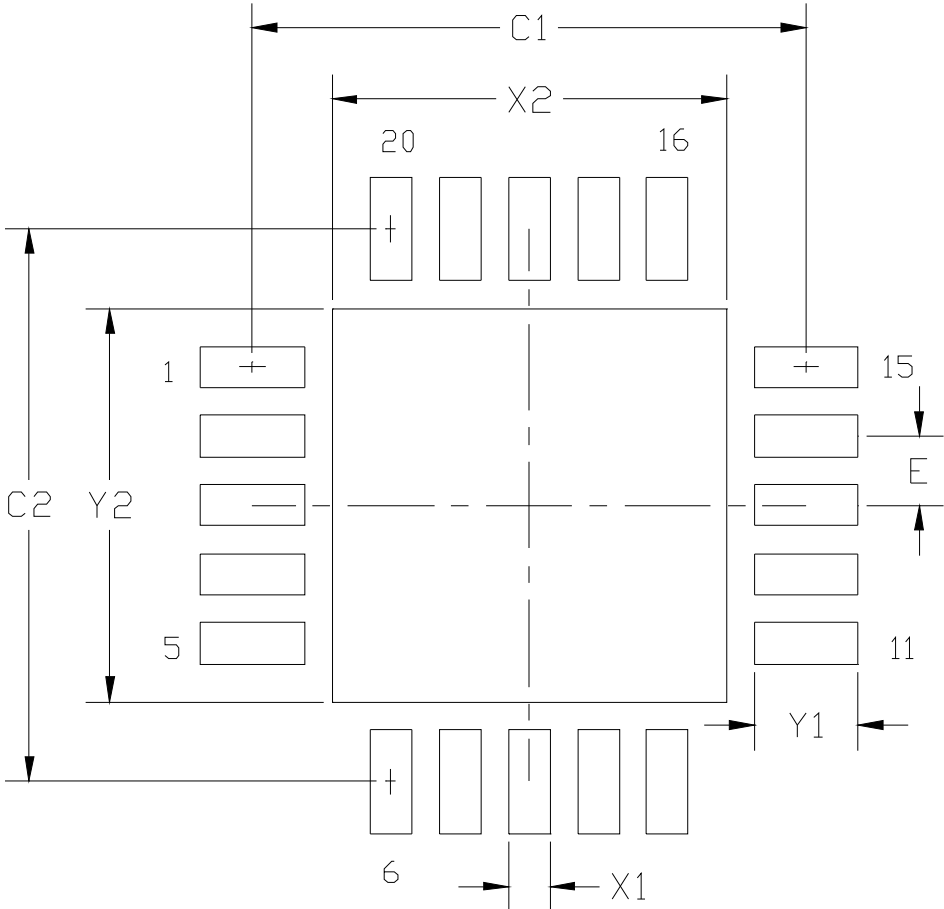

Figure 22. PCB Land Pattern

Table 17. PCB Land Pattern Dimensions

Symbol	Millimeters	
	Min	Max
C1	3.90	4.00
C2	3.90	4.00
E	0.50 REF	
X1	0.20	0.30
X2	2.65	2.75
Y1	0.65	0.75
Y2	2.65	2.75

Notes: General

1. All dimensions shown are in millimeters (mm) unless otherwise noted.
2. This land pattern design is based on IPC-7351 guidelines.

Note: Solder Mask Design

1. All metal pads are to be non-solder mask defined (NSMD). Clearance between the solder mask and the metal pad is to be 60 μm minimum, all the way around the pad.

Notes: Stencil Design

1. A stainless steel, laser-cut and electro-polished stencil with trapezoidal walls should be used to assure good solder paste release.
2. The stencil thickness should be 0.125 mm (5 mils).
3. The ratio of stencil aperture to land pad size should be 1:1 for the perimeter pads.
4. A 2x2 array of 1.10 x 1.10 mm openings on 1.30 mm pitch should be used for the center ground pad.

Notes: Card Assembly

1. A No-Clean, Type-3 solder paste is recommended.
2. The recommended card reflow profile is per the JEDEC/IPC J-STD-020 specification for small body components.

DOCUMENT CHANGE LIST

Revision 1.0 to Revision 1.1

- Corrected typo under Features/Low Power Consumption on page 1.

CONTACT INFORMATION

Silicon Laboratories Inc.

400 West Cesar Chavez
Austin, TX 78701
Tel: 1+(512) 416-8500
Fax: 1+(512) 416-9669
Toll Free: 1+(877) 444-3032

Please visit the Silicon Labs Technical Support web page:
<https://www.silabs.com/support/pages/contacttechnicalsupport.aspx>
and register to submit a technical support request.

The information in this document is believed to be accurate in all respects at the time of publication but is subject to change without notice. Silicon Laboratories assumes no responsibility for errors and omissions, and disclaims responsibility for any consequences resulting from the use of information included herein. Additionally, Silicon Laboratories assumes no responsibility for the functioning of undescribed features or parameters. Silicon Laboratories reserves the right to make changes without further notice. Silicon Laboratories makes no warranty, representation or guarantee regarding the suitability of its products for any particular purpose, nor does Silicon Laboratories assume any liability arising out of the application or use of any product or circuit, and specifically disclaims any and all liability, including without limitation consequential or incidental damages. Silicon Laboratories products are not designed, intended, or authorized for use in applications intended to support or sustain life, or for any other application in which the failure of the Silicon Laboratories product could create a situation where personal injury or death may occur. Should Buyer purchase or use Silicon Laboratories products for any such unintended or unauthorized application, Buyer shall indemnify and hold Silicon Laboratories harmless against all claims and damages.

Silicon Laboratories and Silicon Labs are trademarks of Silicon Laboratories Inc.
Other products or brandnames mentioned herein are trademarks or registered trademarks of their respective holders.