

# mikromedia+

for TIVA® ARM®

---

Amazingly compact, all-on-single-pcb development board carrying 4.3" TFT Touch Screen and lots of multimedia peripherals, all driven by powerful **TM4C123GH6PGEI** microcontroller from ARM® Cortex™-M4 family



# To our valued customers

I want to express my thanks to you for being interested in our products and for having confidence in MikroElektronika.

The primary aim of our company is to design and produce high quality electronic products and to constantly improve the performance thereof in order to better suit your needs.

A handwritten signature in white ink, appearing to read 'N. Matic', is positioned in the bottom right corner of the page.

Nebojsa Matic  
General Manager



# Table of Contents

Introduction to mikromedia+ for TIVA® ARM®	6	4. RTC Battery and Reset Button	20
System Specification	6	5. Crystal oscillator and 2.048V reference	22
Package Contains	7	6. MicroSD Card Slot	24
1. Power supply	8	7. Touch Screen	26
2. TM4C123GH6PGEI microcontroller	10	8. Audio Module	28
Key microcontroller features	10	9. USB DEVICE connection	30
3. Programming the microcontroller	11	10. USB HOST connection	32
Programming with mikroBootloader	12	11. Accelerometer	34
step 1 – Connecting mikromedia	12	12. Flash Memory	36
step 2 – Browsing for .HEX file	13	13. RF transceiver	38
step 3 – Selecting .HEX file	13	14. Buzzer	40
step 4 – Uploading .HEX file	14	15. Other modules	42
step 5 – Finish upload	15	16. Pads	44
Programming with mikroProg™ programmer	16		
mikroProg™ suite™ for ARM® software	18		
Software installation wizard	19		

# Introduction to mikromedia+ for TIVA®

The central part of the system is a 32-bit ARM® Cortex™-M4 TM4C123GH6PGEI microcontroller. The mikromedia+ for TIVA® ARM® features integrated modules such as stereo MP3 codec, 4.3" TFT 480x272 touch screen display, accelerometer, microSD card slot, buzzer, IR receiver, RGB LED diode, PIN photodiode, temperature sensor, 2.4GHz RF transceiver, 8 Mbit flash memory, RTC battery, Li-Polimer battery charger etc. The board also contains MINI-B USB connector, power screw terminals, 2x5 JTAG connector, two 1x26 connection pads, ON/OFF switch and other. It comes pre-programmed with USB HID bootloader, but can also be programmed with external programmers, such as mikroProg™ for TIVA® or other JTAG programmers. Mikromedia is compact and slim, and perfectly fits in the palm of your hand, which makes it a convenient platform for mobile and other multimedia devices.

## System Specification



### power supply

Via USB cable [5V DC] or via screw terminals [2.5-12V DC]



### power consumption

26 mA with erased MCU  
(when on-board modules are inactive)



### board dimensions

119.54 x 78 mm [4.71 x 3.07 inch]



### weight

~270g [0.595 lbs]

# Package Contains



- 01 Damage resistant protective box



- 02 mikromedia+ for TIVA®



- 03 USB cable and microSD card with adapter

**mikromedia+**  
for TIVA® ARM

Knowledge compiled, all in English for development board learning  
4.3" TFT Touch Screen and lots of multimedia peripherals, all  
driven by powerful OMAP3530/3530G1 microcontroller from older  
Cortex-M4 family



- 04 mikromedia+ for TIVA® ARM®  
user's guide

# 1. Power supply

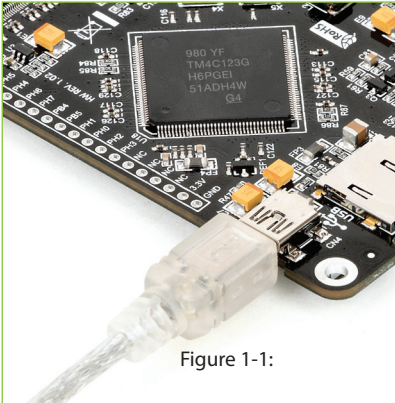

Figure 1-1:

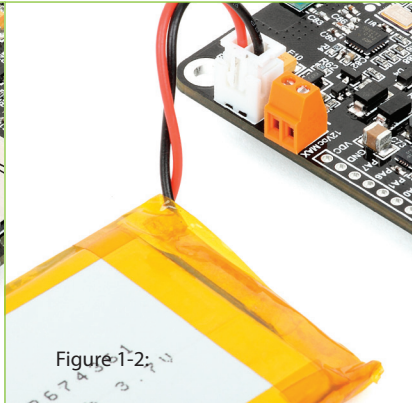

Figure 1-2:

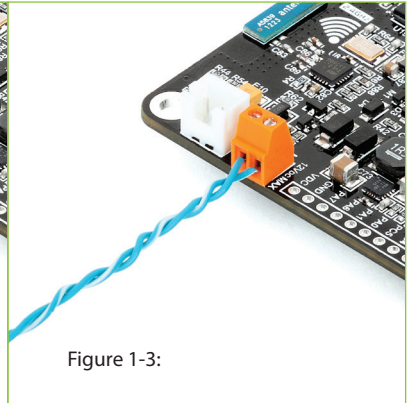
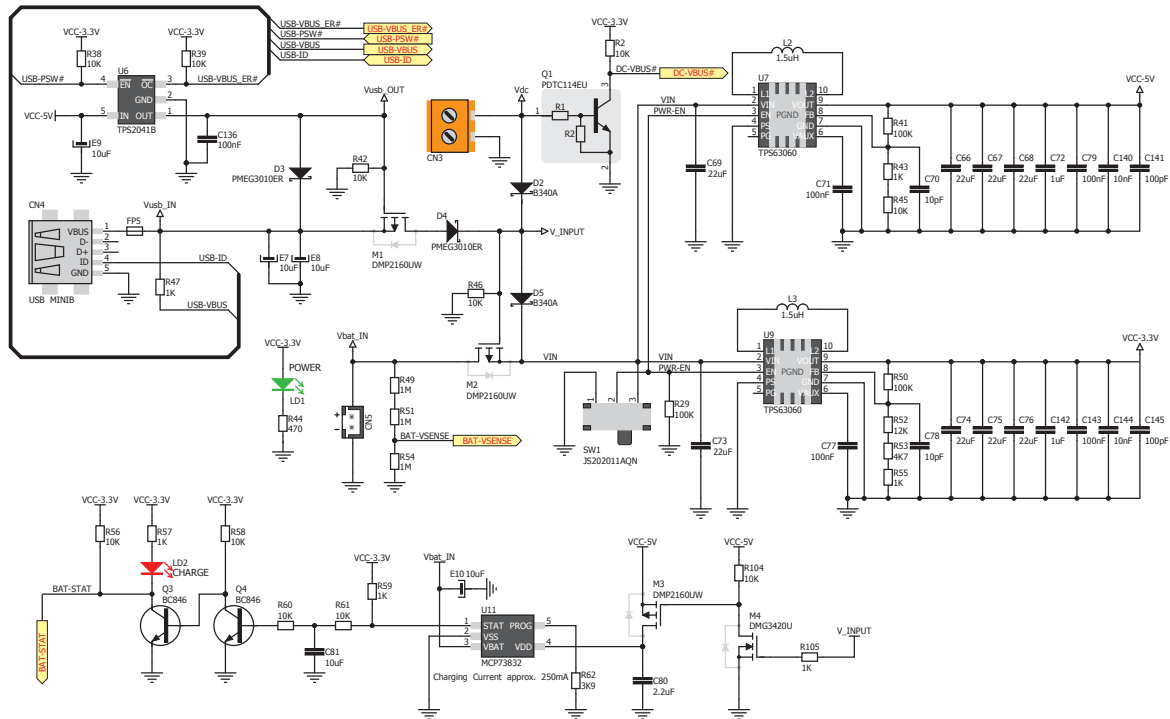

Figure 1-3:

The mikromedia+ for TIVA® ARM® board can be powered in three different ways: via USB connector using MINI-B USB cable provided with the board [CN4], via battery connector using Li-Polymer battery [CN5] or via screw terminals using laboratory power supply [CN3]. After you plug in the appropriate power supply turn the power switch ON [SW1]. The USB connection can provide up to 500mA of current which is more than enough for the operation of all on-board modules and the microcontroller as well. If you decide to use external power supply via screw terminals, voltage values must be within 2.5-12V DC range. Power LED ON [GREEN] indicates the presence of power supply. On-board battery charger circuit MCP73832 enables you to charge the battery over USB connection or via screw terminals. LED diode [RED]





## 2. TM4C123GH6PGEI MCU features

All members of the Tiva™ C Series, including the TM4C123GH6PGE microcontroller, are designed around an ARM Cortex-M processor core. It has a 32-bit ARM® Cortex™-M4F 80-MHz processor core with System Timer [SysTick], integrated Nested Vectored Interrupt Controller [NVIC], Wake-Up Interrupt Controller [WIC] with clock

### Key microcontroller features

- ARM Cortex-M4F CPU, 80-MHz operation;
- 256KB of Flash memory;
- 32KB of SRAM memory;
- 2KB of EEPROM memory;
- up to 105 I/O pins;
- 16/32-bit timers
- 16MHz internal oscillator, 32kHz RTCC;
- 8xUART, 4xSPI, 6xI<sup>2</sup>C, 2xCAN, 2xADC, USB etc.

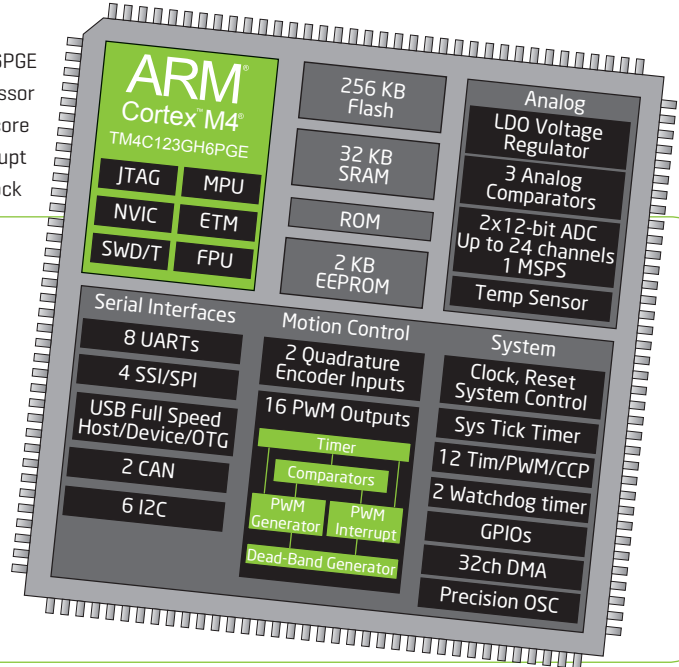

# 3. Programming the microcontroller

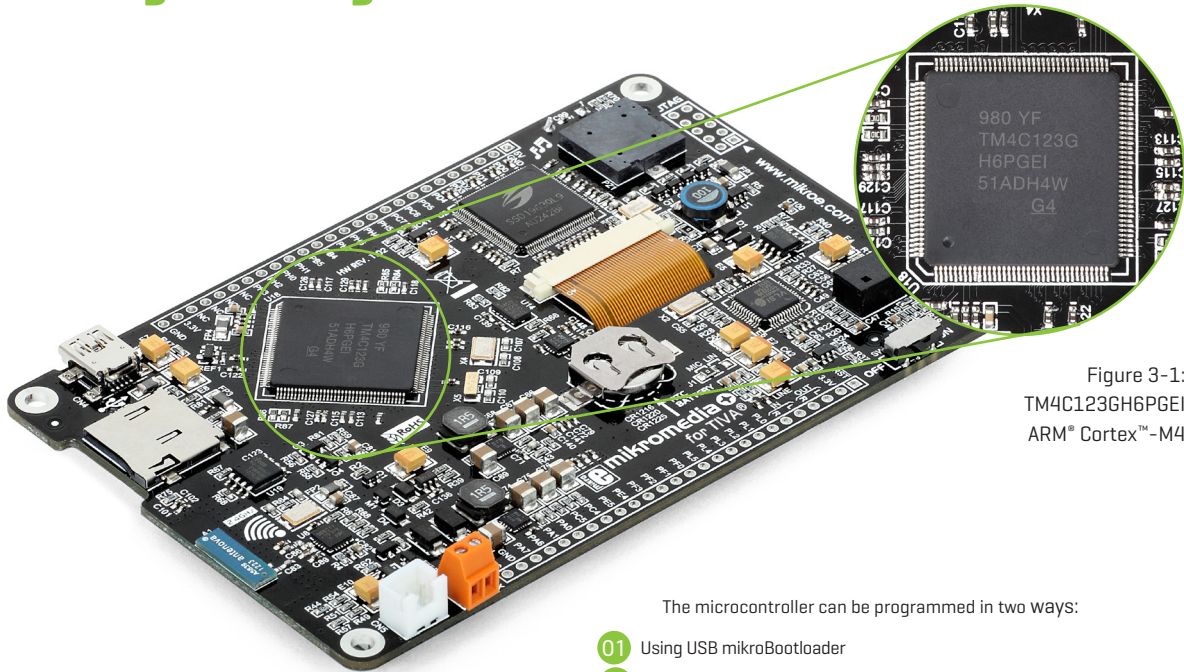

Figure 3-1:  
TM4C123GH6PGEI  
ARM® Cortex™-M4

The microcontroller can be programmed in two ways:

- 01 Using USB mikroBootloader
- 02 Using external mikroProg™ for TIVA® or other JTAG programmers

# Programming with mikroBootloader

You can program the microcontroller with bootloader which is pre-programmed into the device by default. To transfer .HEX file from a PC to MCU you need bootloader software [mikroBootloader USB HID] which can be downloaded from:

<http://download.mikroe.com/examples/smart-displays/mikromedia/4/tiva/mikromedia-4-tiva-mikrobootloader-usb-hid-v130.zip>

After software is downloaded unzip it to desired location and start mikroBootloader USB HID software.

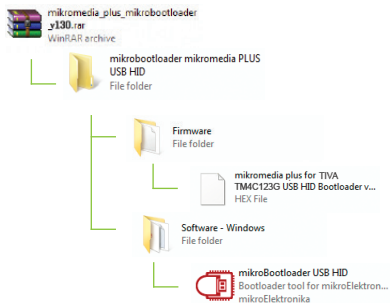

## step 1 – Connecting mikromedia



- 01 To start connect the USB cable or (if already connected) press the **Reset** button on your mikromedia+ board. Click the **Connect** button within 5s to enter the bootloader mode, otherwise existing microcontroller program will execute.

## step 2 – Browsing for .HEX file



Figure 3-3: Browse for HEX

- 01 Click the **Browse for HEX** button and from a pop-up window [Figure 3.4] choose the .HEX file that will be uploaded to MCU memory.

## step 3 – Selecting .HEX file

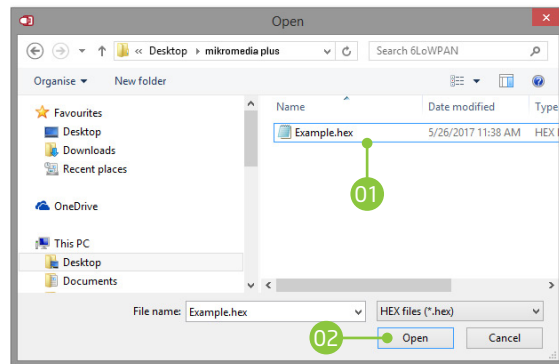

Figure 3-4: Selecting HEX

- 01 Select .HEX file using open dialog window.
- 02 Click the **Open** button.

## step 4 – Uploading .HEX file

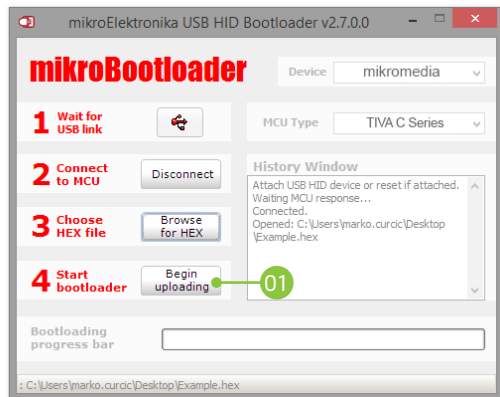

Figure 3-5: Begin uploading

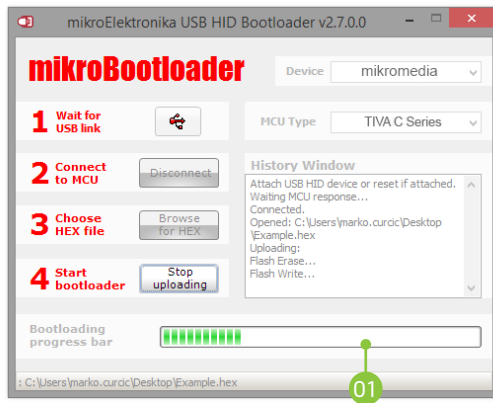

Figure 3-6: Progress bar

- 01 To start .HEX file uploading click the **Begin uploading** button.

- 01 You can monitor .HEX file uploading via progress bar

## step 5 – Finish upload

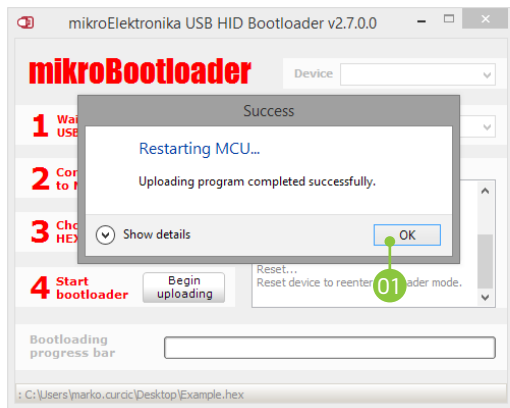

Figure 3-7: Restarting MCU

- 01 Click the **OK** button after uploading is finished. Board will automatically reset and after 5 seconds your new program will execute.



Figure 3-8: mikroBootloader ready for next job

# Programming with mikroProg™ programmer

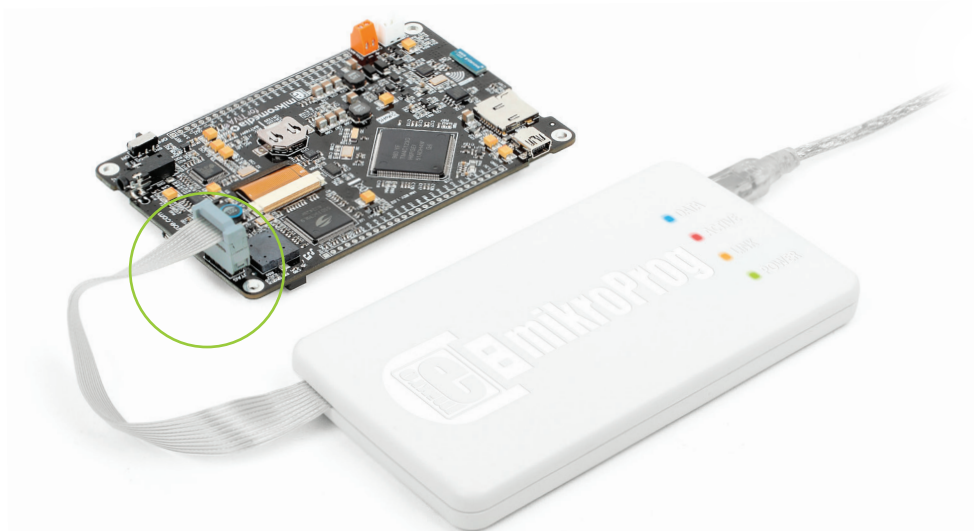

Figure 3-9:  
mikroProg™

The microcontroller can be programmed with external mikroProg™ for TIVA® programmer and mikroProg Suite™ for ARM® software. The external programmer is connected to the development system via JTAG connector, Figure 3-9. mikroProg™ is a fast USB 2.0 programmer with hardware Debugger support. It supports ARM® Cortex™-M3 and Cortex™-M4 microcontrollers from TIVA®. Outstanding performance, easy operation and elegant design are its key features.





# mikroProg Suite™ for ARM® software

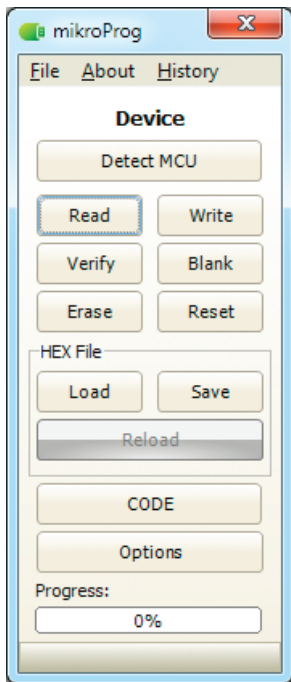

mikroProg™ for TIVA® programmer requires special programming software called mikroProg Suite™ for ARM®. This software is used for programming ALL of TIVA® ARM® Cortex-M3™ and Cortex-M4™ microcontroller families. It features intuitive interface and SingleClick™ programming technology. Software installation is available on a Product DVD:

After downloading, extract the package and double click the executable setup file, to start installation.

## Quick Guide

- 01 Click the **Detect MCU** button in order to recognize the device ID.
- 02 Click the **Read** button to read the entire microcontroller memory. You can click the **Save** button to save it to target HEX file.
- 03 If you want to write the HEX file to the microcontroller, first make sure to load the target HEX file using the **Load** button. Then click the **Write** button to begin programming.
- 04 Click the **Erase** button to wipe out the microcontroller memory.

# Software installation wizard

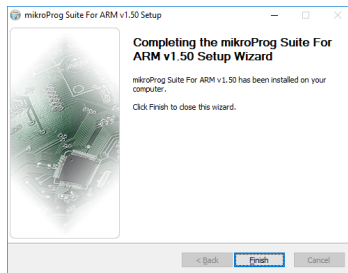
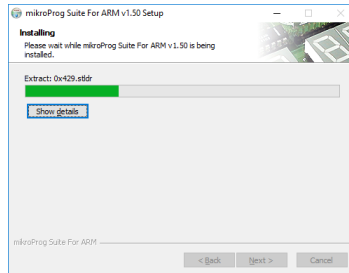
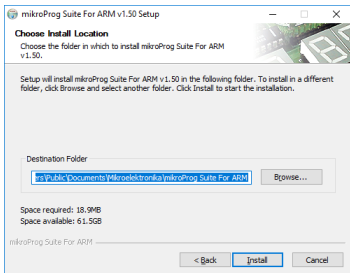
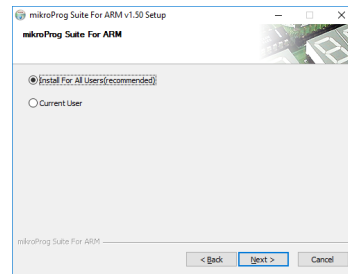
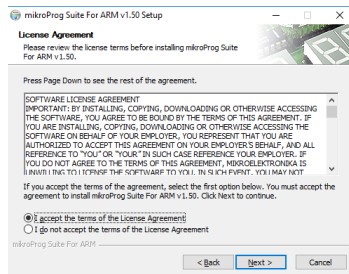
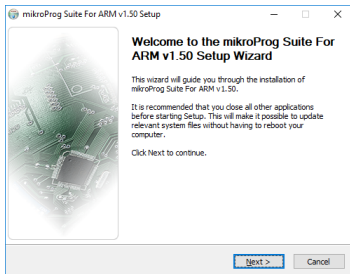

## 4. RTC Battery and Reset Button

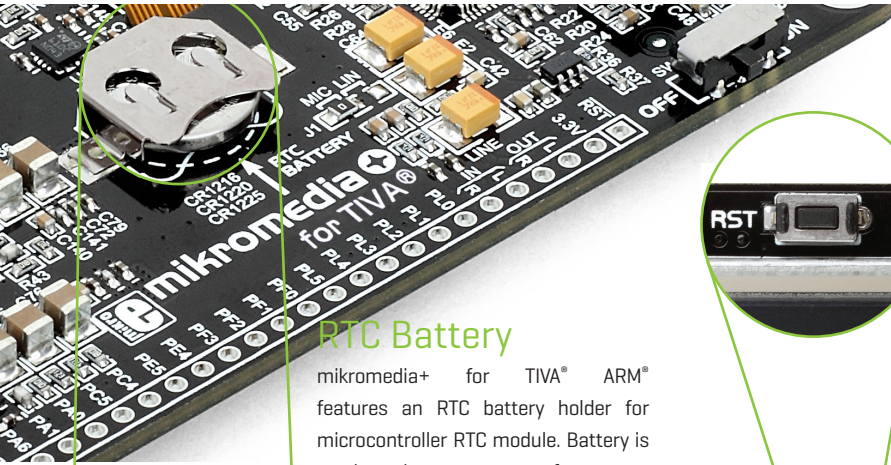

### RTC Battery

mikromedia+ for TIVA® ARM® features an RTC battery holder for microcontroller RTC module. Battery is used as alternate source of power, so the RTC module can continue to keep time while the primary source of power is off or currently unavailable. Three types of coin battery are supported: CR1216, CR1220 and CR1225.

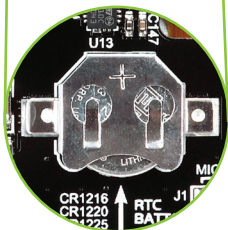

### Reset Button

The board is equipped with reset button, which is located on the front side of the board. If you want to reset the circuit, press the reset button. It will generate low voltage level on the microcontroller reset pin [input]. A reset can also be externally provided through the pin 27 on the side headers.





## 5. Crystal oscillator and 2.048V reference

The board is equipped with **01** 16MHz crystal oscillator [X4] circuit that provides external clock waveform to the microcontroller OSC0 and OSC1 pins. This base frequency is suitable for further clock multipliers and ideal for generation of necessary USB clock, which ensures proper operation of bootloader and your custom USB-based applications. The board also contains **02** 32.768 kHz crystal oscillator [X5] which provides external clock for internal RTCC module. Microcontroller ADC requires an accurate source of reference voltage signal. That is why we provide the external **03** voltage reference to the microcontroller VREF pin which is 2.048V.

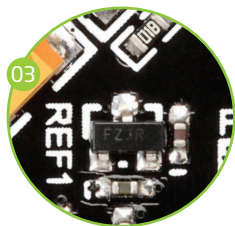
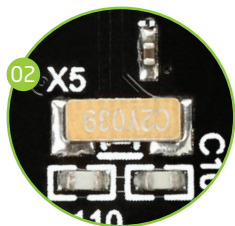
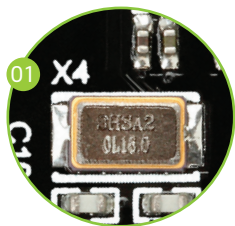
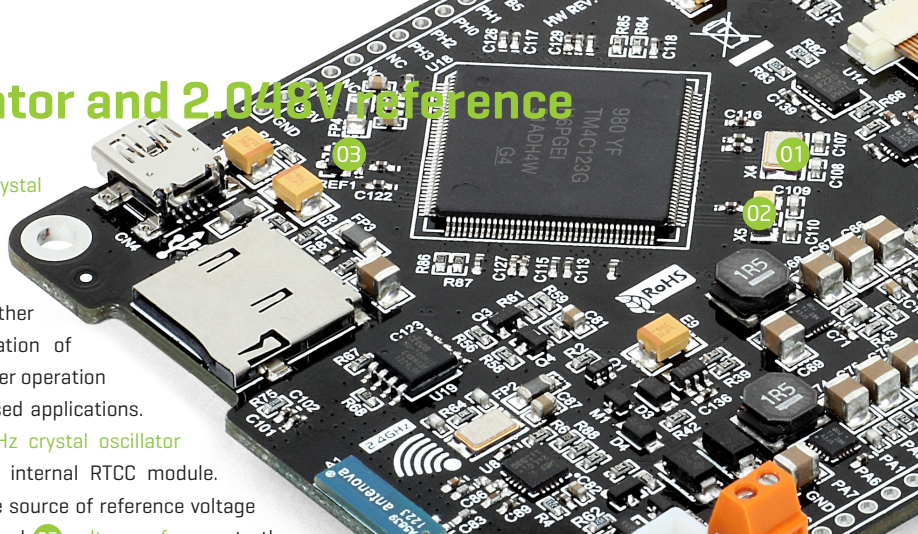
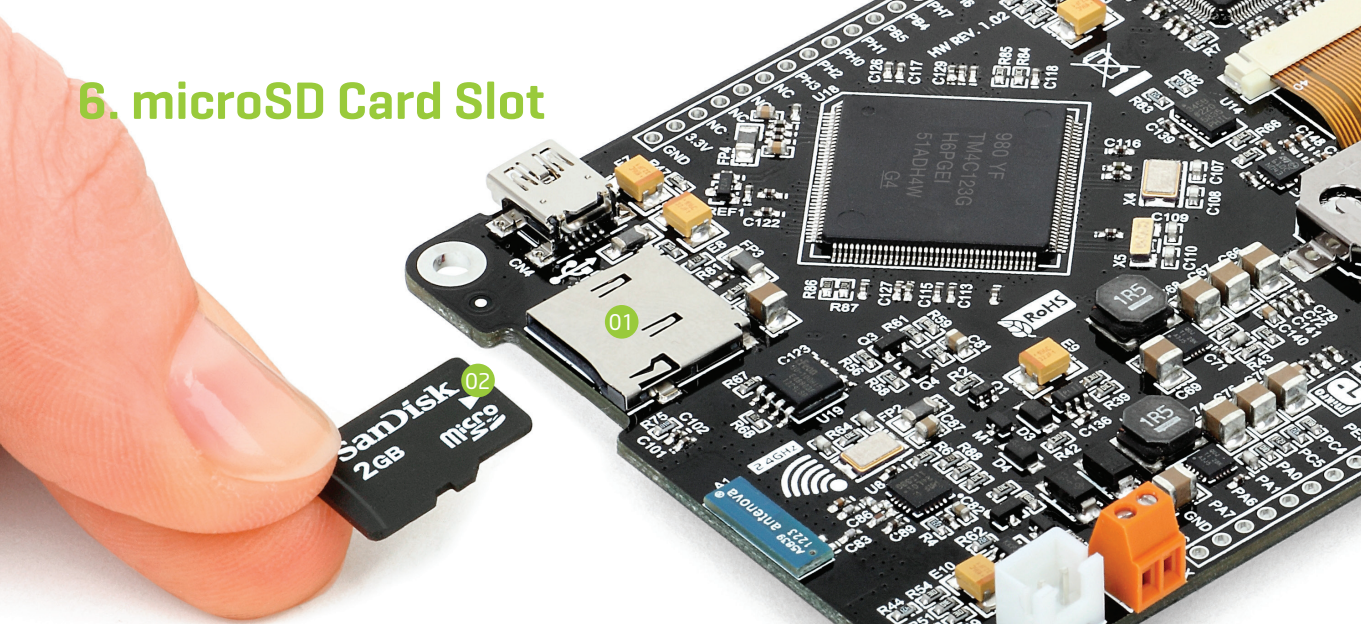

Figure 5-1: Crystal oscillator and 2.048V reference



## 6. microSD Card Slot



Board contains **01** microSD card slot for using **02** microSD cards in your projects. It enables you to store large amounts of data externally, thus saving microcontroller memory. microSD cards use Serial Peripheral Interface [SPI] for communication with the microcontroller. Ferrite and capacitor are provided to compensate the voltage and current glitch that can occur when pushing-in and pushing-out microSD card

Figure 6-1:  
microSD card slot



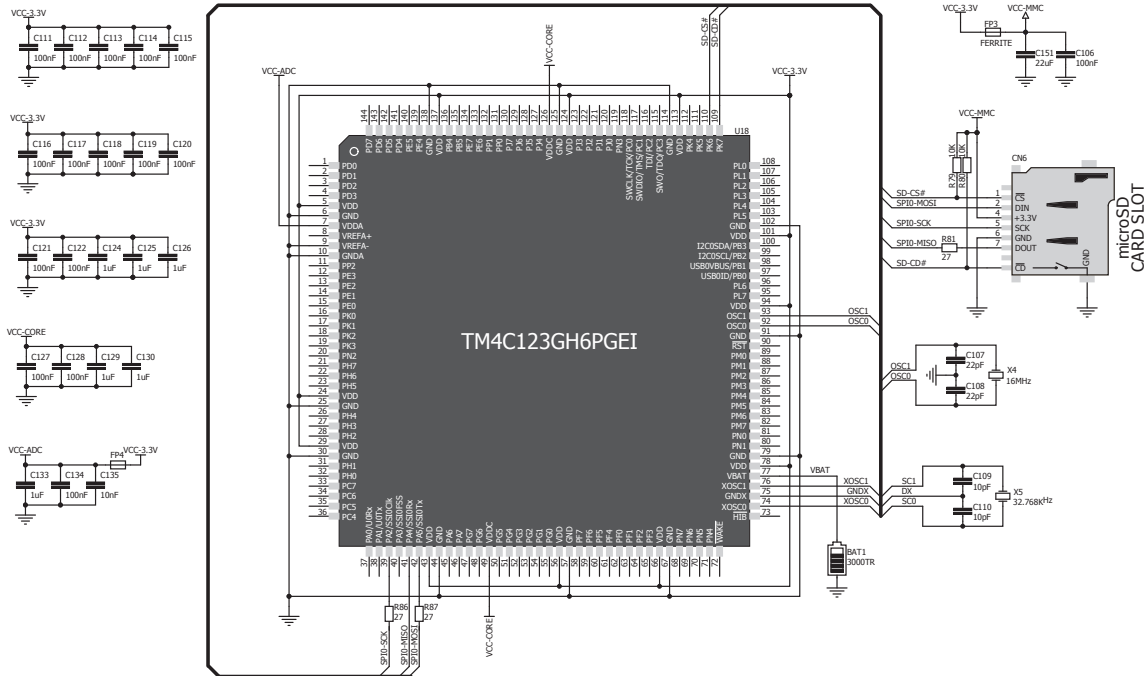

Figure 6-2: microSD Card Slot module connection schematic



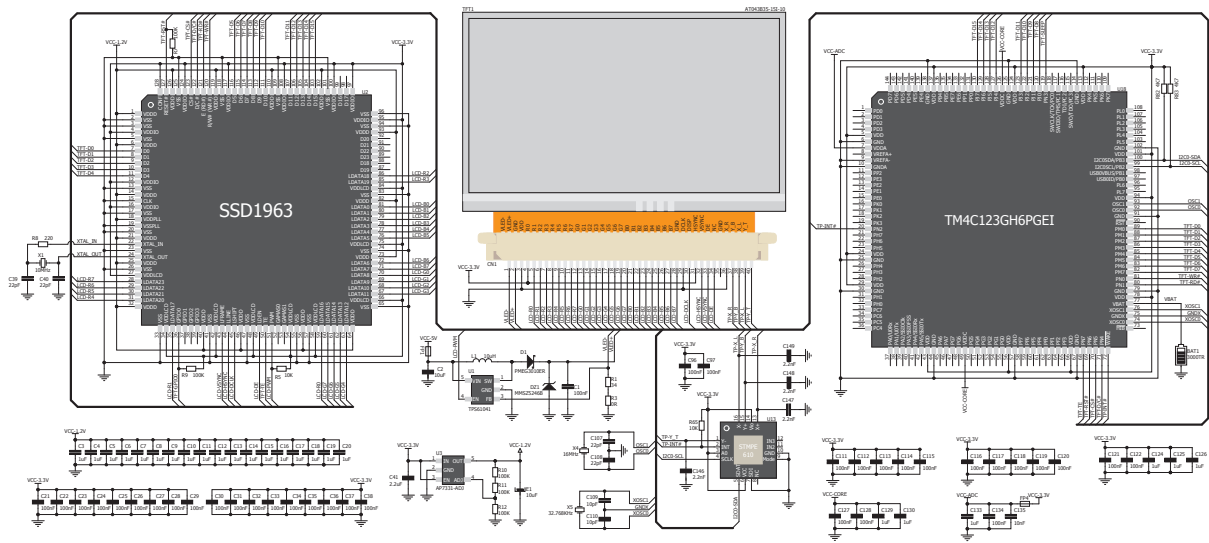
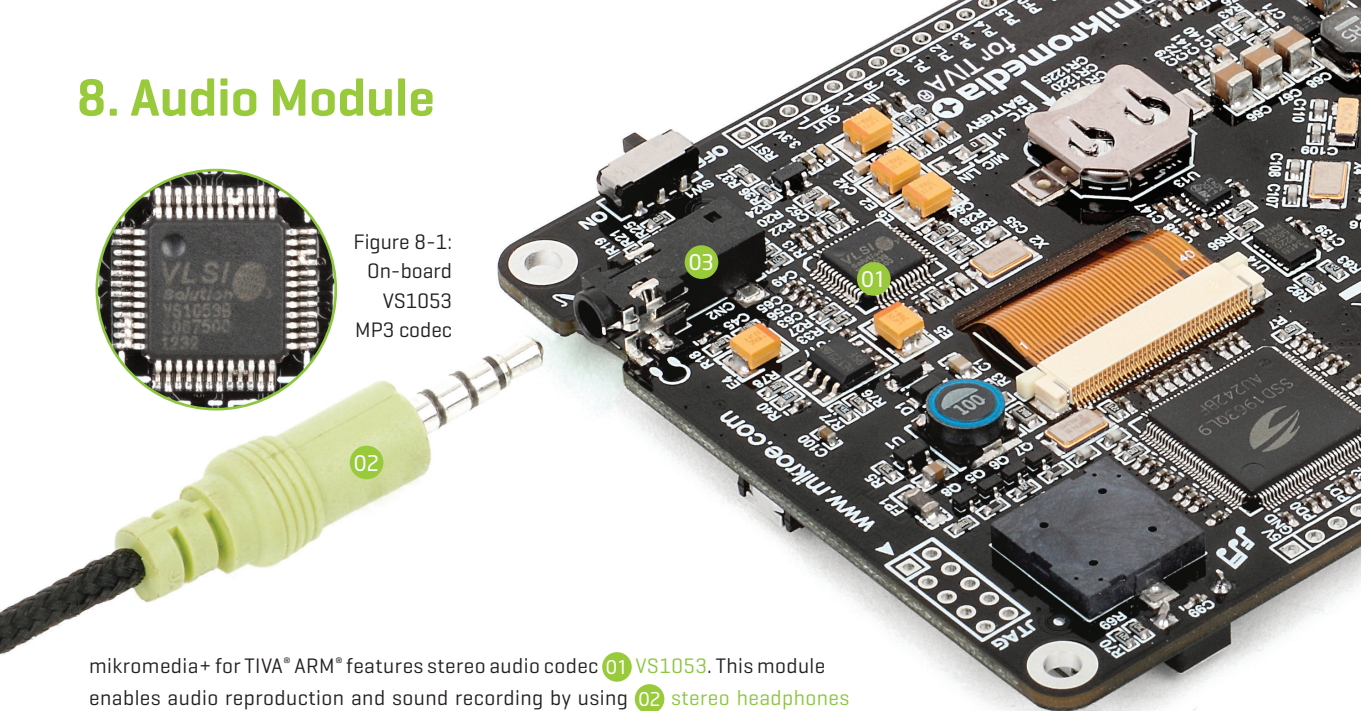

Figure 7-2: Touch Screen connection schematic

## 8. Audio Module



Figure 8-1:  
On-board  
VS1053  
MP3 codec



mikromedia+ for TIVA® ARM® features stereo audio codec **01 VS1053**. This module enables audio reproduction and sound recording by using **02 stereo headphones with microphone** connected to the system via a **03 3.5mm** connector CN2. All functions of this module are controlled by the microcontroller over Serial Peripheral Interface [SPI]. IN and OUT channels are also provided on side headers.

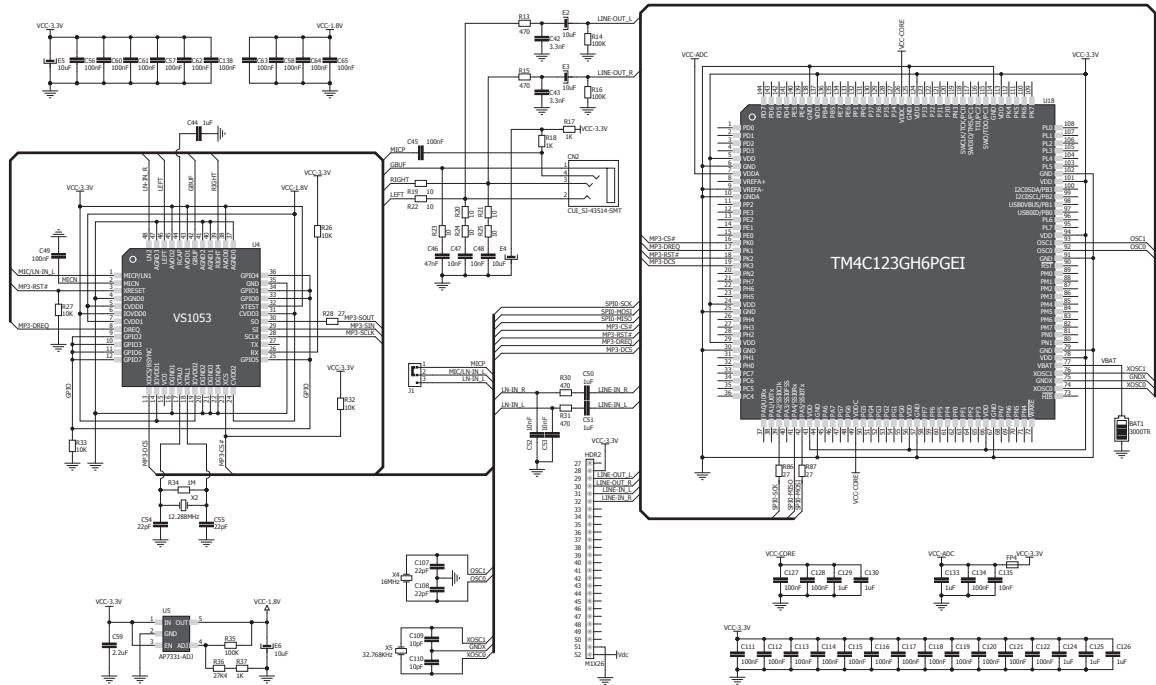

Figure 8-2: Audio module connection schematic

## 9. USB DEVICE connection

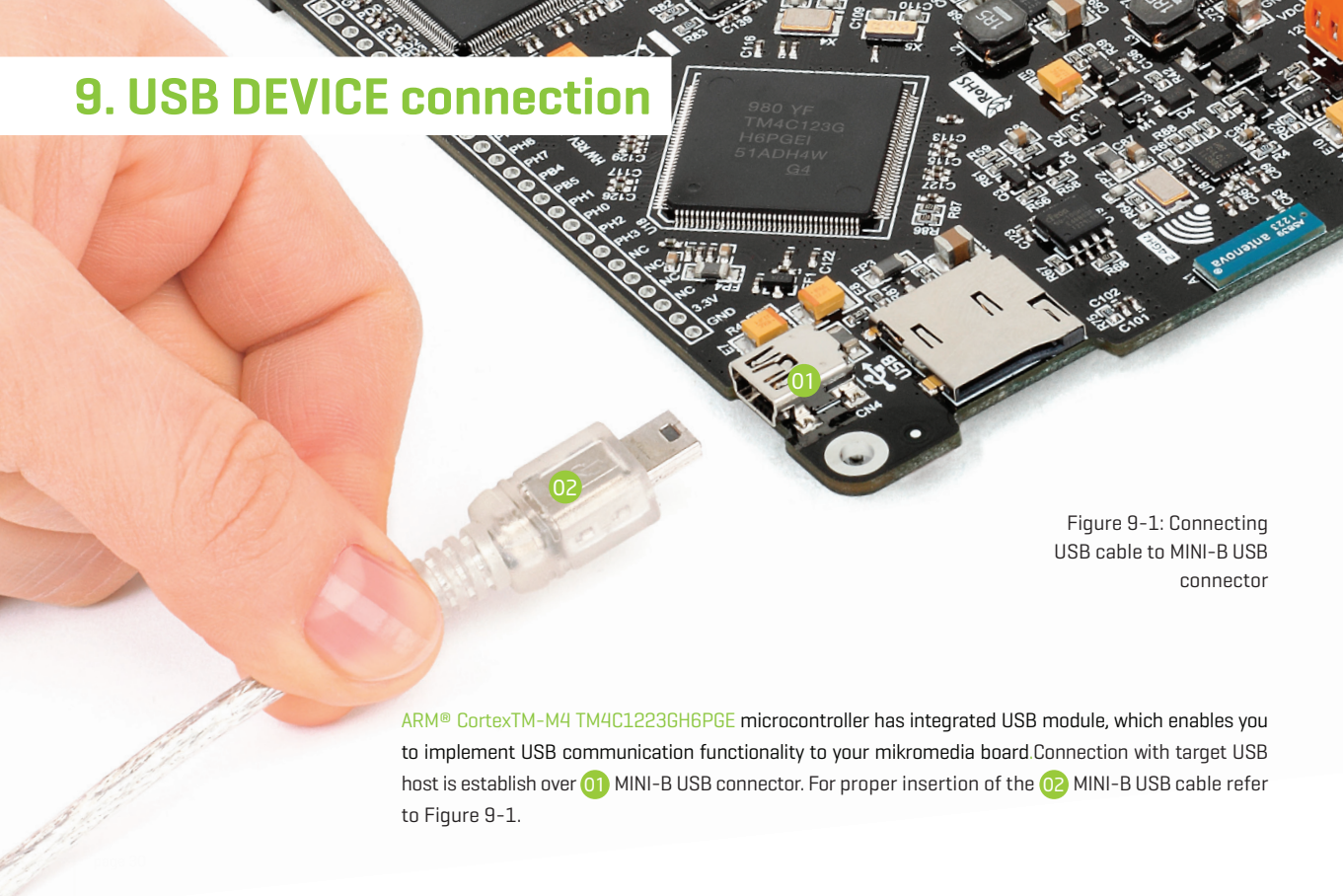

Figure 9-1: Connecting USB cable to MINI-B USB connector

ARM® Cortex™-M4 TM4C123G6H6PGE microcontroller has integrated USB module, which enables you to implement USB communication functionality to your mikromedia board Connection with target USB host is establish over 01 MINI-B USB connector. For proper insertion of the 02 MINI-B USB cable refer to Figure 9-1.

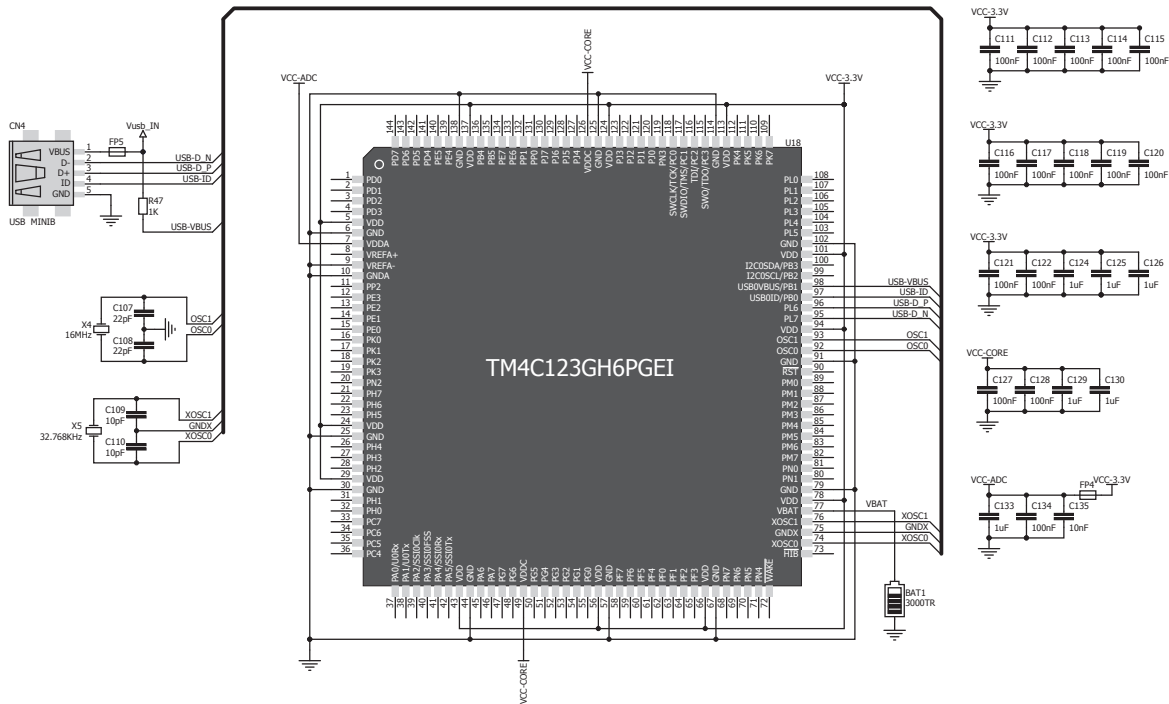

Figure 9-2: USB DEVICE module connection schematic

## 10. USB HOST connection

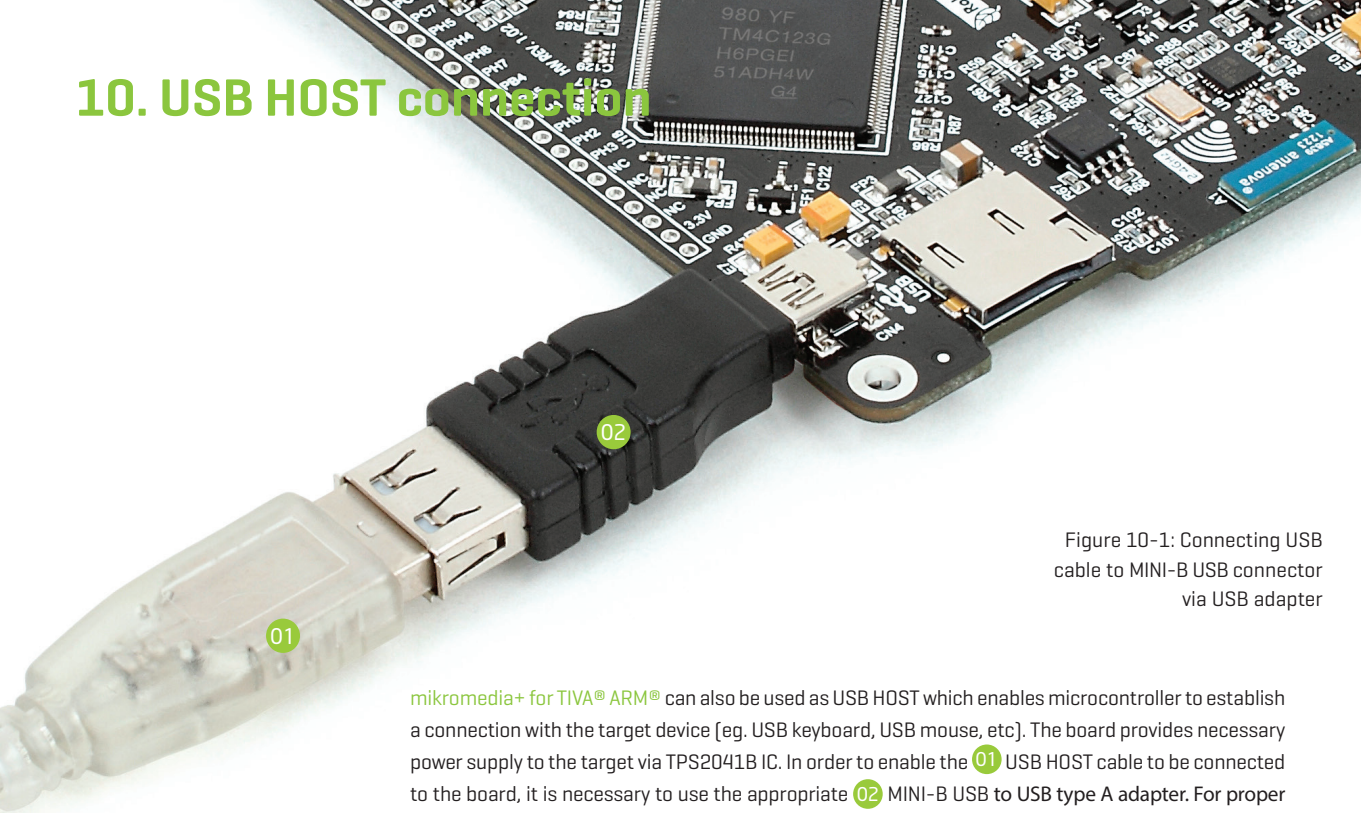

Figure 10-1: Connecting USB cable to MINI-B USB connector via USB adapter

**mikromedia+** for TIVA® ARM® can also be used as USB HOST which enables microcontroller to establish a connection with the target device [eg. USB keyboard, USB mouse, etc]. The board provides necessary power supply to the target via TPS2041B IC. In order to enable the **01** USB HOST cable to be connected to the board, it is necessary to use the appropriate **02** MINI-B USB to USB type A adapter. For proper



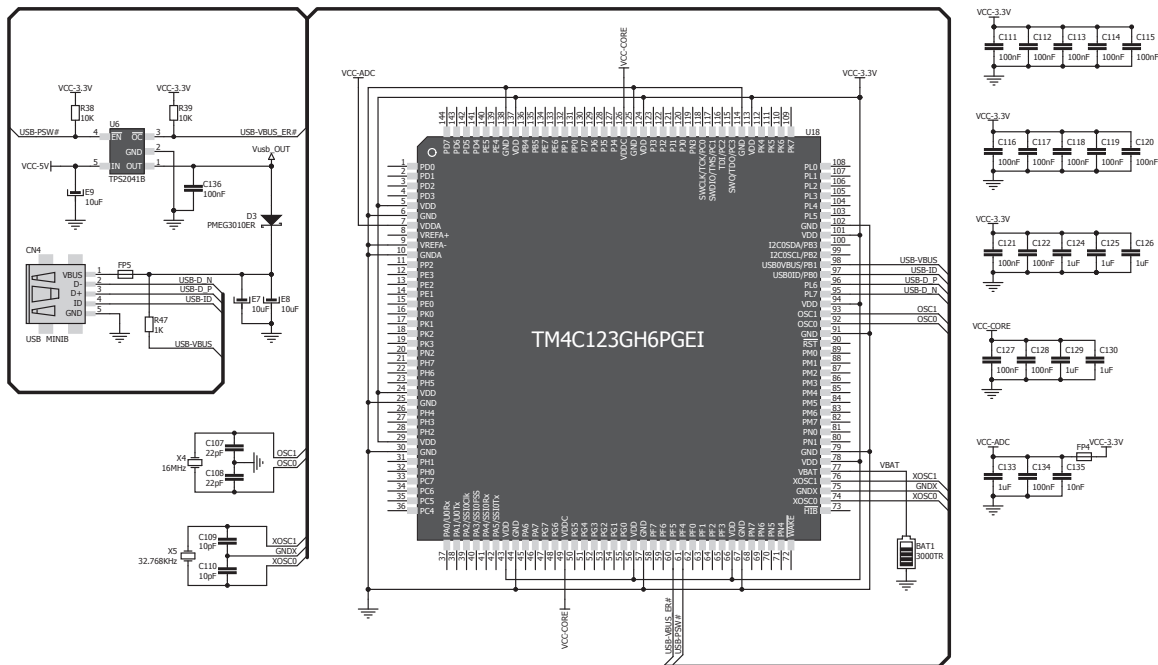

Figure 10-2: USB HOST module connection schematic

# 11. Accelerometer

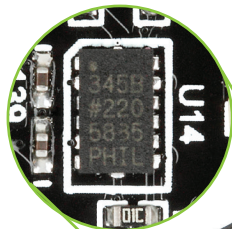
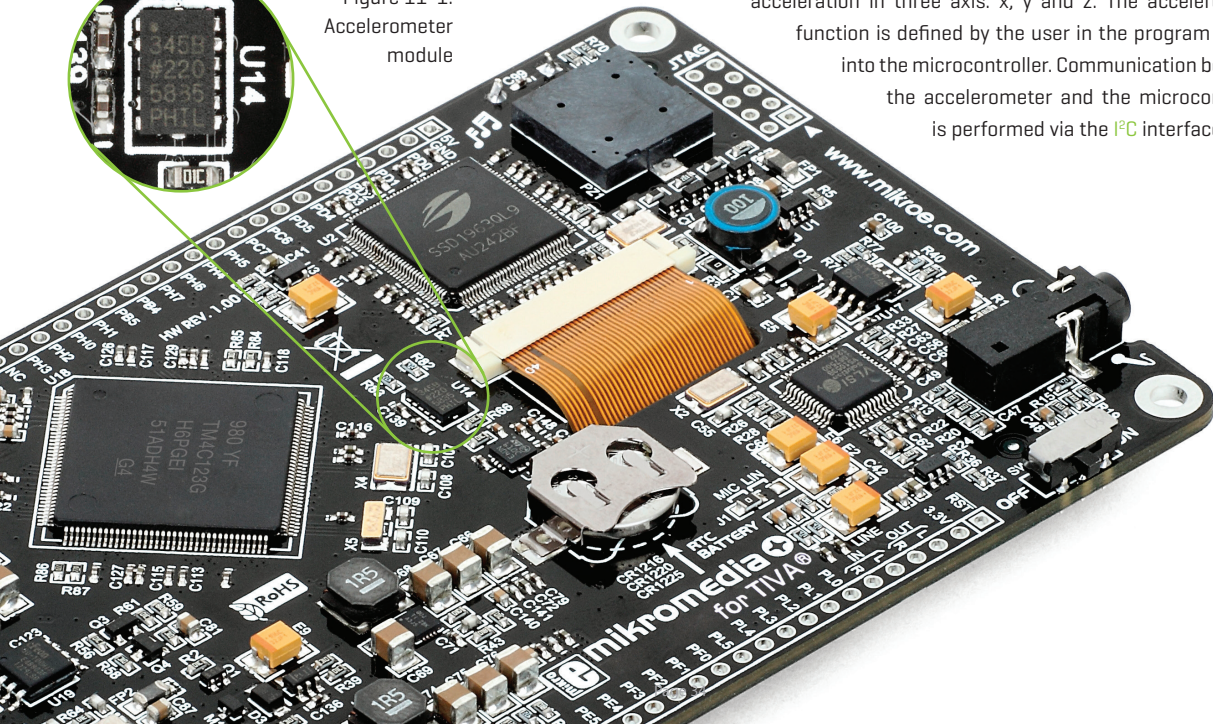

Figure 11-1:  
Accelerometer  
module

On board **ADXL345** accelerometer is used to measure acceleration in three axis: x, y and z. The accelerometer function is defined by the user in the program loaded into the microcontroller. Communication between the accelerometer and the microcontroller is performed via the **I<sup>2</sup>C** interface.





## 12. Flash Memory

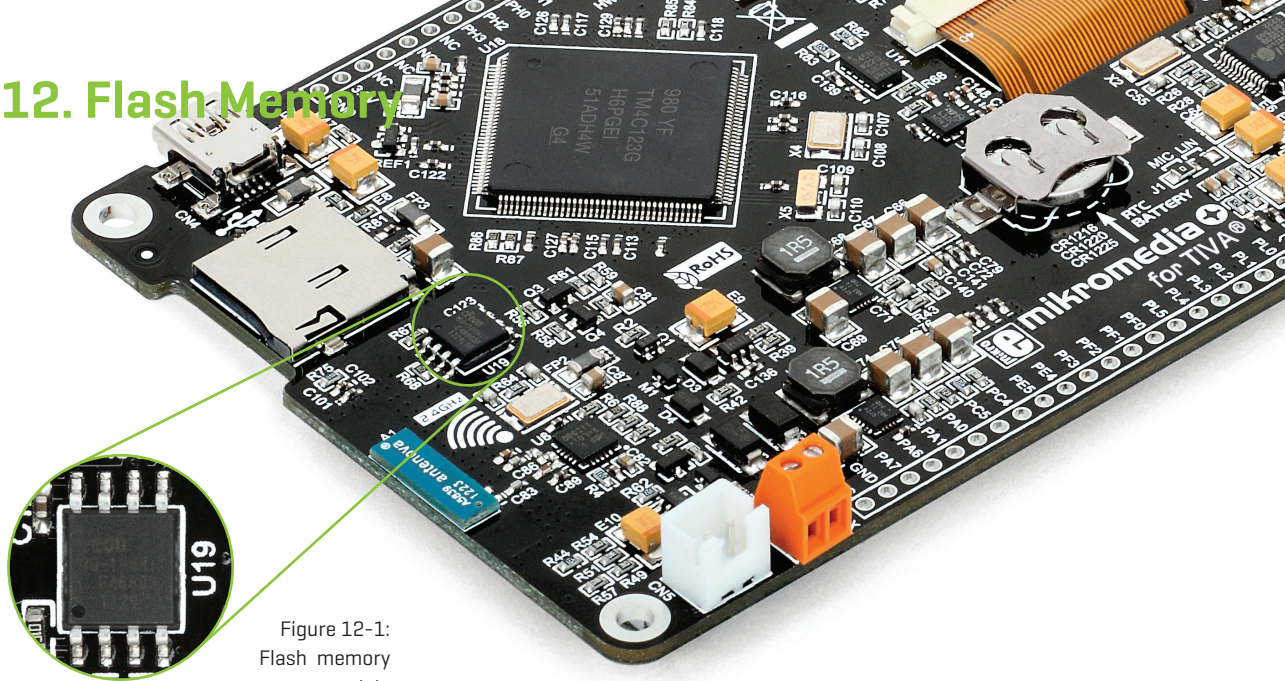
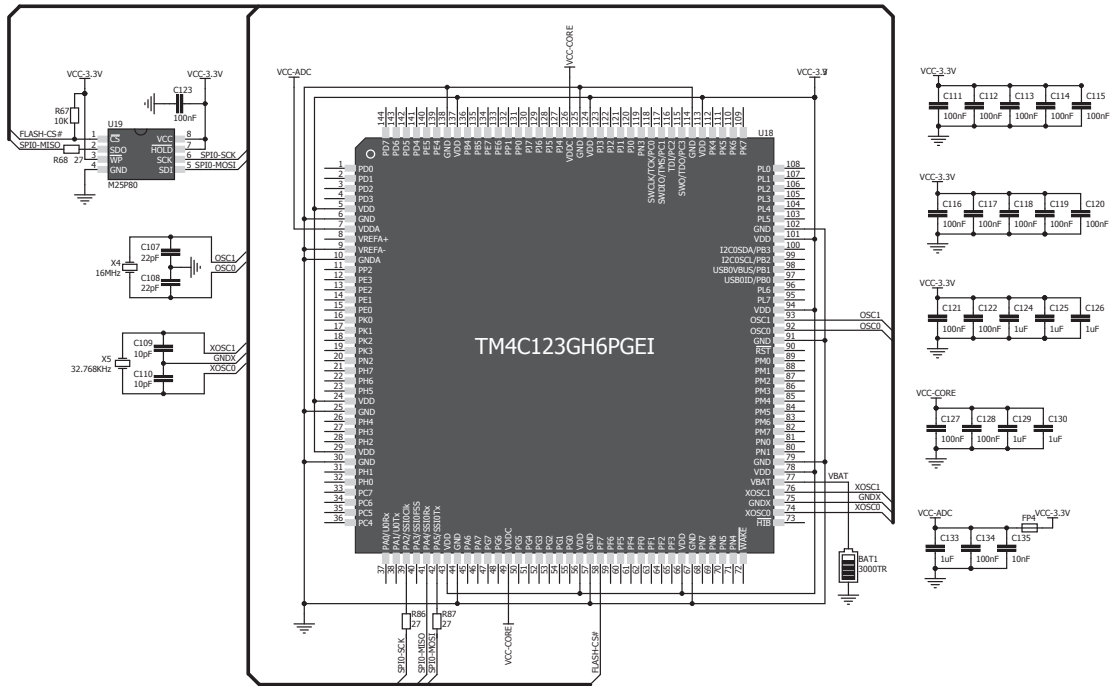

Figure 12-1:  
Flash memory  
module

Since multimedia applications are getting increasingly demanding, it is necessary to provide additional memory space to be used for storing more data. The flash memory module enables the microcontroller to use additional **8Mbit** flash memory. It is connected to the microcontroller via the Serial Peripheral Interface [SPI].



## 13. RF Transceiver



Figure 13-1:  
RF transceiver antenna

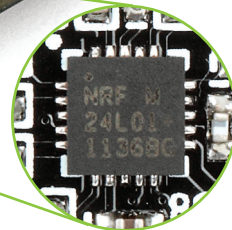

Figure 13-2:  
RF transceiver module

mikromedia+ for TIVA® ARM® board features **RF transceiver** chip with **2.4GHz chip antenna**. It is suitable for wireless operation in the world wide ISM frequency band at 2.400 - 2.4835 GHz with air data rate up to 2Mbps. RF transceiver module is connected to the microcontroller via the Serial Peripheral Interface [SPI]. This RF transceiver module is widely used for wireless PC peripherals, remote controllers, VoIP headsets, game controllers, sensors, home and commercial automation, active RFID, toys and many more.

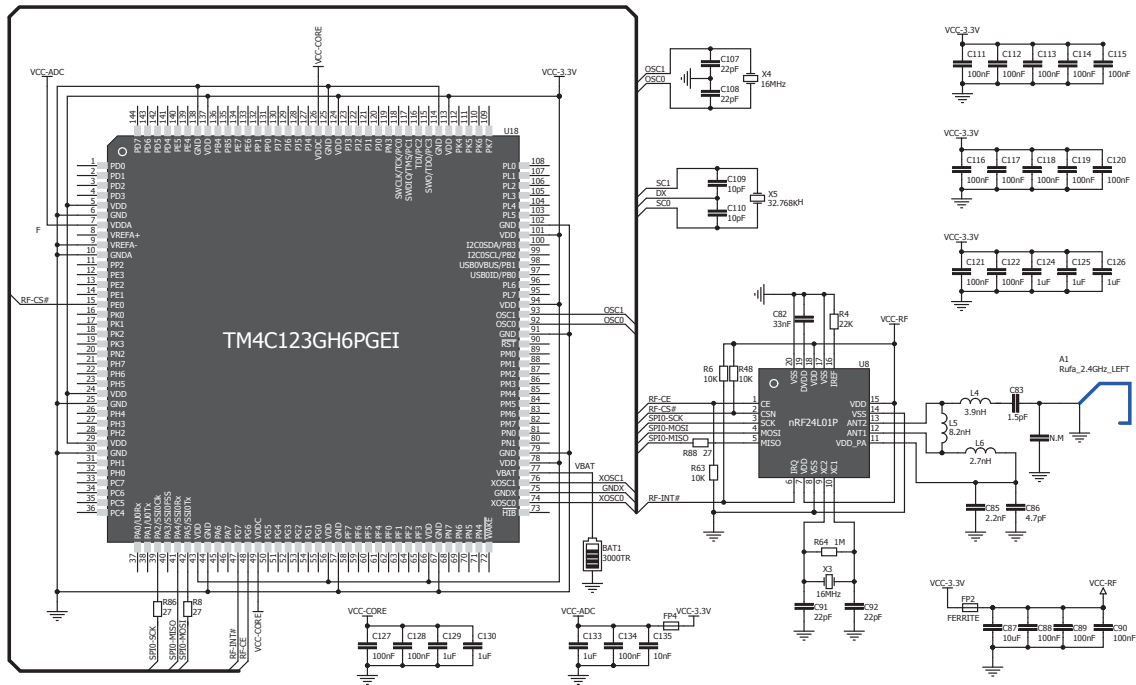

Figure 13-3: RF transceiver module schematic

# 14. Buzzer

The board is also equipped with piezo buzzer. It is an electric component which can be used to create sound waves when provided with electrical signal. Microcontroller can create sound by generating a PWM signal. Frequency of the signal determines the pitch of the sound and duty cycle of the signal can be used to increase or decrease the volume.

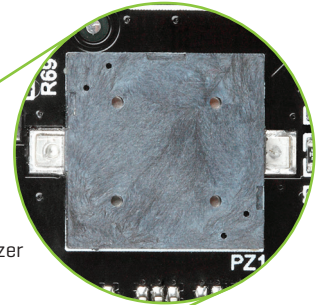
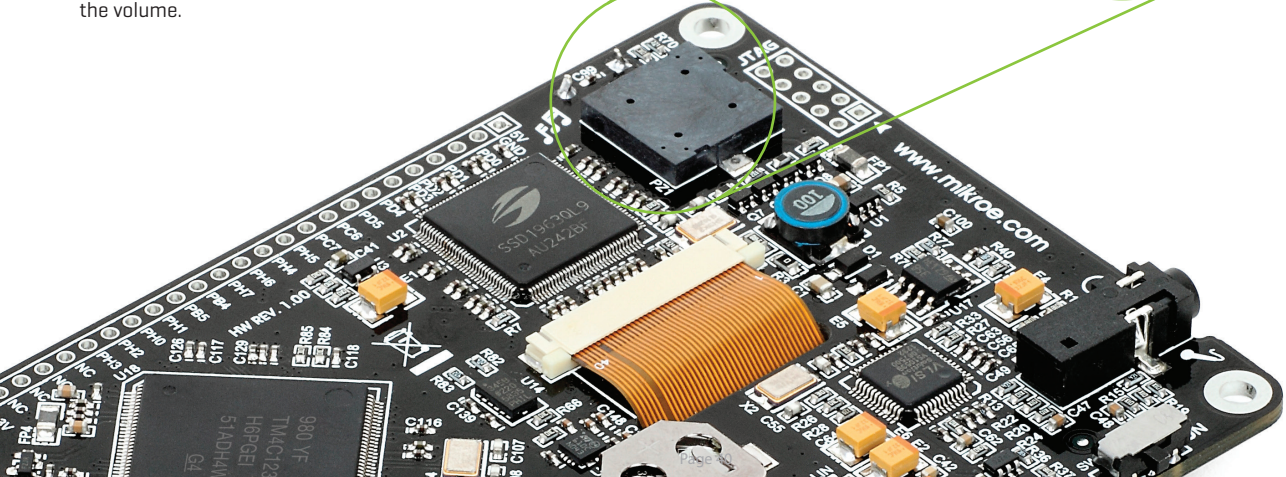

Figure 14-1: Buzzer module





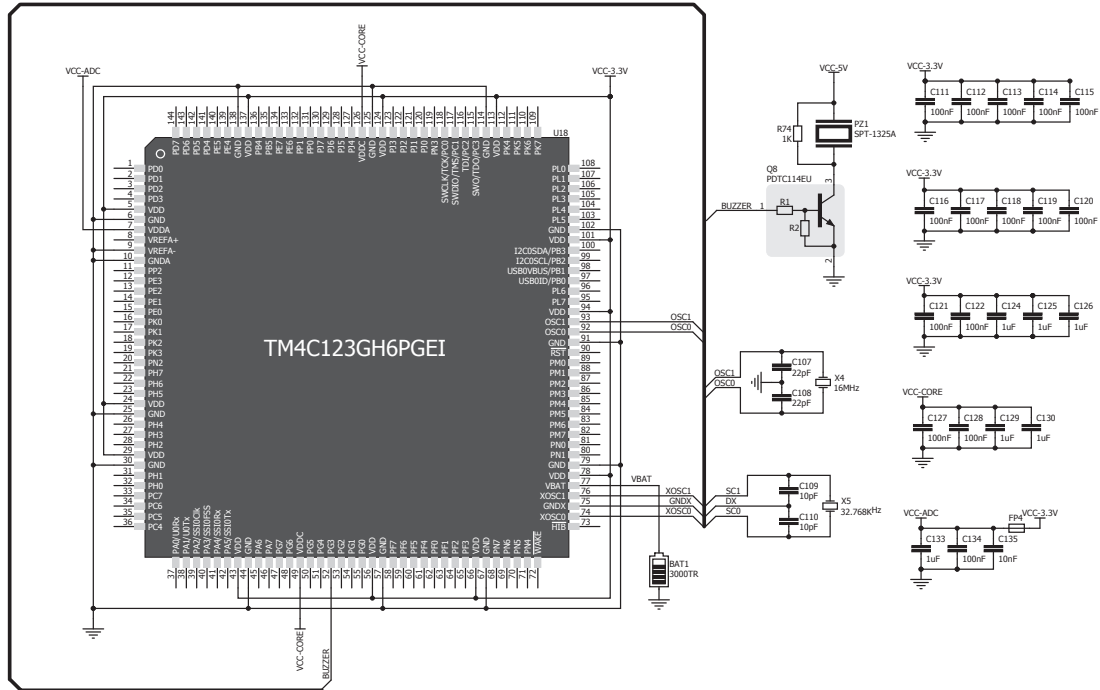
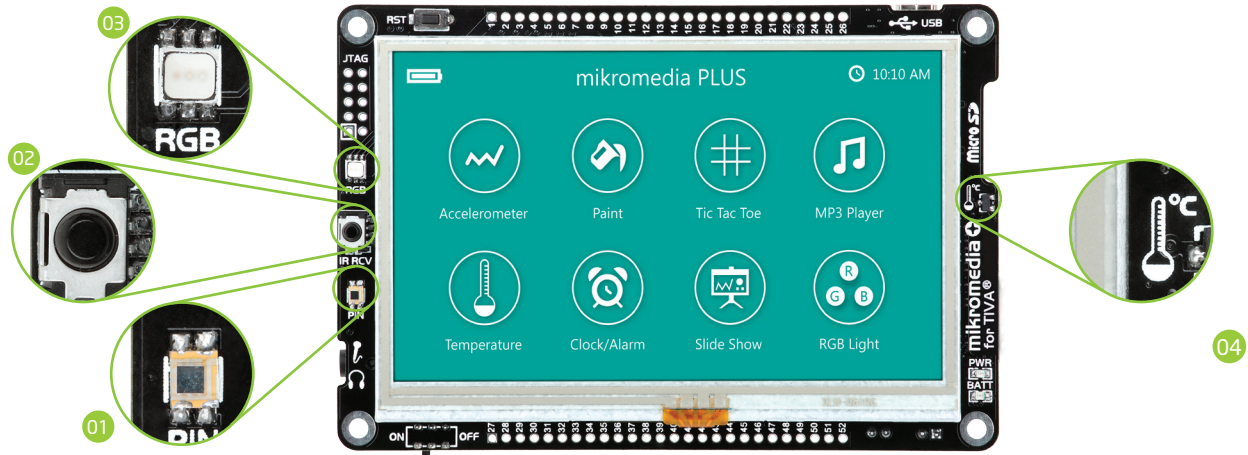
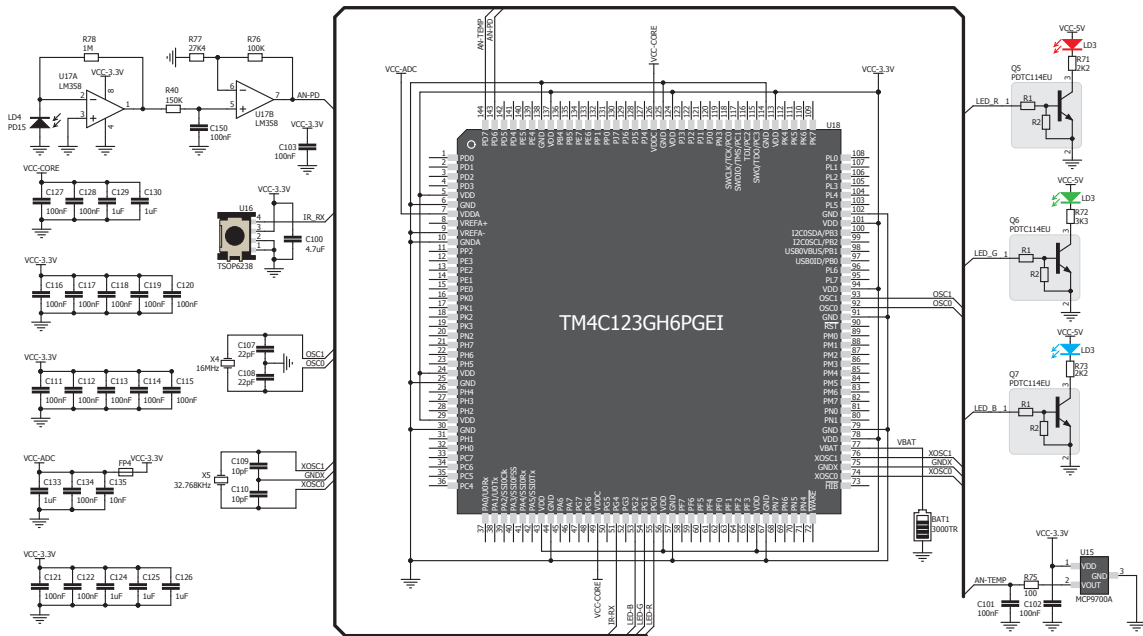

Figure 14-2: Buzzer module schematic

# 15. Other modules



The board also contains additional peripherals that can be very useful, such as **01** PIN photodiode, **02** IR receiver, **03** RGB led diode and **04** analog temperature sensor. **PIN photodiode** is a type of photo detector capable of converting light into the voltage with high sensitivity and speed of response. It is connected to the microcontroller analog pin. **IR receiver** is used for infrared remote control systems. The demodulated output signal obtained from IR module can be directly decoded by a microcontroller. Many of existing standard data formats are supported. **RGB [Red, Green, Blue] diode** is suitable for light indication in your design. Each of colour is driven separately by transistor. The **analog temperature sensor** converts temperature to analog voltage and it is directly connected to the microcontroller analog pin. Temperature measurement range of mikromedia+ for TIVA® ARM® board is from -20°C to 70°C.



# 16. Pads

■ PWM 
 ■ Interrupt 
 ■ I2C 
 ■ UART 
 ■ Analog lines 
 ■ SPI 
 ■ CAN

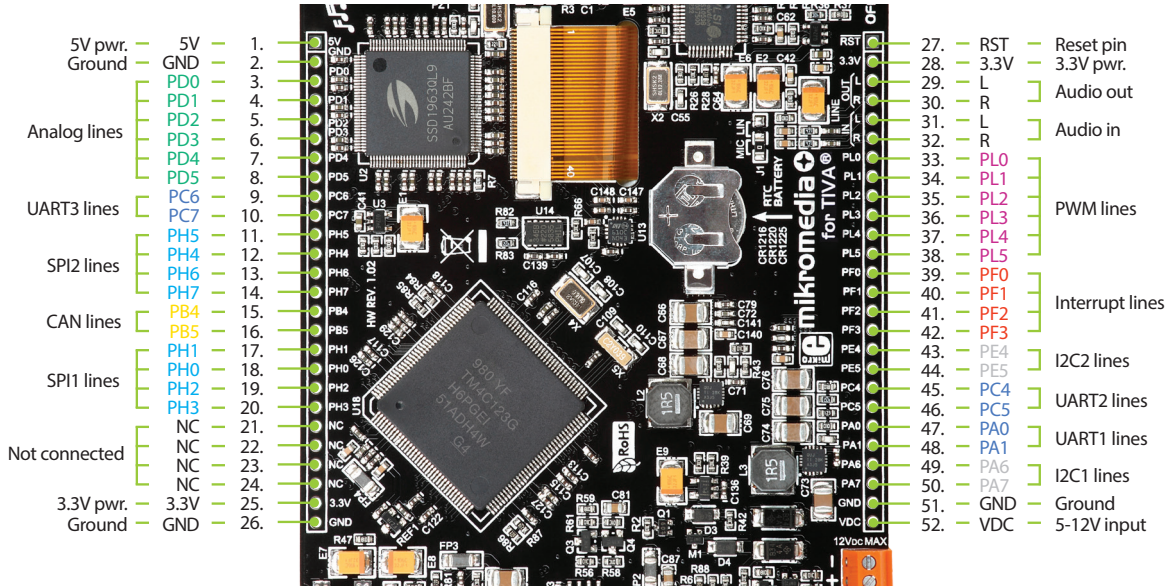

Many microcontroller pins are available for further connectivity via two 1x26 rows of connection pads on both sides of the board.









If you want to learn more about our products, please visit our website at [www.mikroe.com](http://www.mikroe.com)

If you are experiencing some problems with any of our products or just need additional information, please place your ticket at [helpdesk.mikroe.com](https://helpdesk.mikroe.com)

If you have any questions, comments or business proposals, do not hesitate to contact us at [office@mikroe.com](mailto:office@mikroe.com)