

IMPORTANT NOTICE

Dear customer,

As of December 7th, 2015 BL RF Power of NXP Semiconductors will operate as an independent company under the new trade name Ampleon, which will be used in future data sheets together with new contact details.

In data sheets, where the previous Philips references is mentioned, please use the new links as shown below.

<http://www.philips.semiconductors.com> use <http://www.ampleon.com>

<http://www.semiconductors.philips.com> use <http://www.ampleon.com> (Internet)

sales.addresses@www.semiconductors.philips.com use
<http://www.ampleon.com/sales>

The copyright notice at the bottom of each page (or elsewhere in the document, depending on the version)

- © Koninklijke Philips Electronics N.V. (year). All rights reserved -
is replaced with:

- © Ampleon B.V. (year). All rights reserved. -

If you have any questions related to the data sheet, please contact our nearest sales office (details via <http://www.ampleon.com/sales>).

Thank you for your cooperation and understanding,

Ampleon

UHF power MOS transistor

BLF521

FEATURES

- High power gain
- Easy power control
- Gold metallization
- Good thermal stability
- Withstands full load mismatch
- Designed for broadband operation.

DESCRIPTION

Silicon N-channel enhancement mode vertical D-MOS transistor designed for communications transmitter applications in the UHF frequency range.

The transistor is encapsulated in a 4-lead, SOT172D studless package, with a ceramic cap. All leads are isolated from the mounting base.

PIN CONFIGURATION

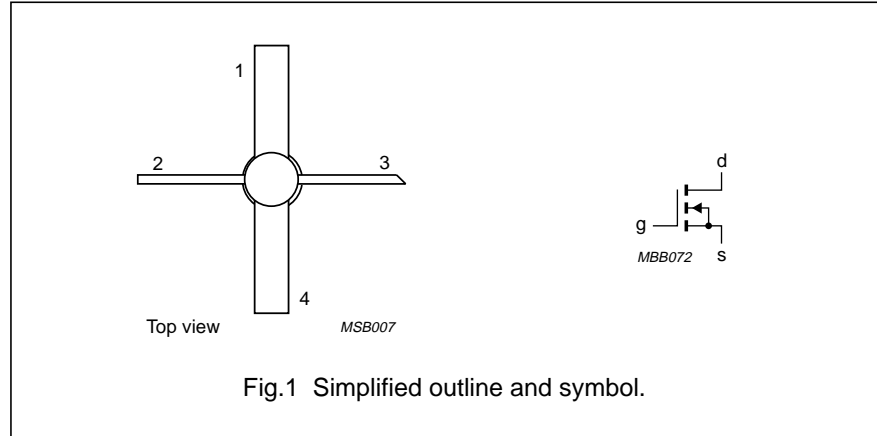

Fig.1 Simplified outline and symbol.

CAUTION

This product is supplied in anti-static packing to prevent damage caused by electrostatic discharge during transport and handling. For further information, refer to Philips specs.: SNW-EQ-608, SNW-FQ-302A, and SNW-FQ-302B.

PINNING - SOT172D

PIN	DESCRIPTION
1	source
2	gate
3	drain
4	source

WARNING

Product and environmental safety - toxic materials

This product contains beryllium oxide. The product is entirely safe provided that the BeO disc is not damaged. All persons who handle, use or dispose of this product should be aware of its nature and of the necessary safety precautions. After use, dispose of as chemical or special waste according to the regulations applying at the location of the user. It must never be thrown out with the general or domestic waste.

QUICK REFERENCE DATA

RF performance at $T_{amb} = 25\text{ }^{\circ}\text{C}$ in a common source test circuit.

MODE OF OPERATION	f (MHz)	V_{DS} (V)	P_L (W)	G_p (dB)	η_D (%)
CW, class-B	500	12.5	2	>10	>50

UHF power MOS transistor

BLF521

LIMITING VALUES

In accordance with the Absolute Maximum System (IEC 60134).

SYMBOL	PARAMETER	CONDITIONS	MIN.	MAX.	UNIT
V_{DS}	drain-source voltage		–	40	V
V_{GS}	gate-source voltage		–	± 20	V
I_D	drain current (DC)		–	1	A
P_{tot}	total power dissipation	$T_{mb} \leq 25\text{ }^\circ\text{C}$	–	10	W
T_{stg}	storage temperature		–65	150	$^\circ\text{C}$
T_j	junction temperature		–	200	$^\circ\text{C}$

THERMAL CHARACTERISTICS

SYMBOL	PARAMETER	VALUE	UNIT
$R_{th\ j-mb}$	thermal resistance from junction to mounting base	17.5	K/W
$R_{th\ j-a}$	thermal resistance from junction to ambient; note1	75	K/W

Note

1. Mounted on printed-circuit board; see Fig.12.

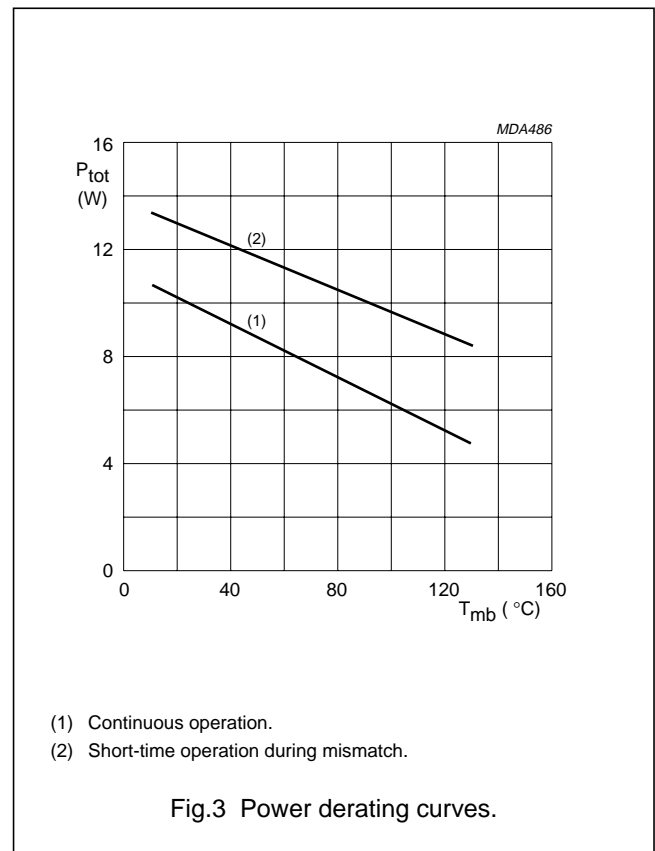
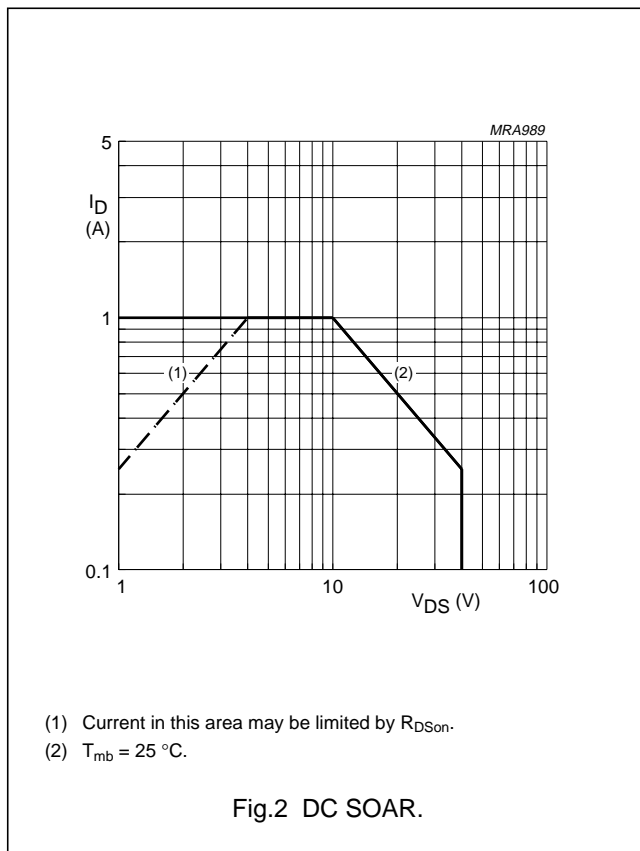

UHF power MOS transistor

BLF521

CHARACTERISTICS $T_j = 25\text{ °C}$ unless otherwise specified.

SYMBOL	PARAMETER	CONDITIONS	MIN.	TYP.	MAX.	UNIT
$V_{(BR)DSS}$	drain-source breakdown voltage	$V_{GS} = 0$; $I_D = 3\text{ mA}$	40	–	–	V
I_{DSS}	drain-source leakage current	$V_{GS} = 0$; $V_{DS} = 12.5\text{ V}$	–	–	10	μA
I_{GSS}	gate-source leakage current	$V_{GS} = \pm 20\text{ V}$; $V_{DS} = 0$	–	–	1	μA
V_{GSth}	gate-source threshold voltage	$I_D = 3\text{ mA}$; $V_{DS} = 10\text{ V}$	2	–	4.5	V
g_{fs}	forward transconductance	$I_D = 0.3\text{ A}$; $V_{DS} = 10\text{ V}$	80	135	–	mS
R_{DSon}	drain-source on-state resistance	$I_D = 0.3\text{ A}$; $V_{GS} = 15\text{ V}$	–	3.5	4	Ω
I_{DSX}	on-state drain current	$V_{GS} = 15\text{ V}$; $V_{DS} = 10\text{ V}$	–	1.3	–	A
C_{is}	input capacitance	$V_{GS} = 0$; $V_{DS} = 12.5\text{ V}$; $f = 1\text{ MHz}$	–	5.3	–	pF
C_{os}	output capacitance	$V_{GS} = 0$; $V_{DS} = 12.5\text{ V}$; $f = 1\text{ MHz}$	–	7.8	–	pF
C_{rs}	feedback capacitance	$V_{GS} = 0$; $V_{DS} = 12.5\text{ V}$; $f = 1\text{ MHz}$	–	1.8	–	pF

 V_{GS} group indicator

GROUP	LIMITS (V)		GROUP	LIMITS (V)	
	MIN.	MAX.		MIN.	MAX.
A	2.0	2.1	O	3.3	3.4
B	2.1	2.2	P	3.4	3.5
C	2.2	2.3	Q	3.5	3.6
D	2.3	2.4	R	3.6	3.7
E	2.4	2.5	S	3.7	3.8
F	2.5	2.6	T	3.8	3.9
G	2.6	2.7	U	3.9	4.0
H	2.7	2.8	V	4.0	4.1
J	2.8	2.9	W	4.1	4.2
K	2.9	3.0	X	4.2	4.3
L	3.0	3.1	Y	4.3	4.4
M	3.1	3.2	Z	4.4	4.5
N	3.2	3.3			

UHF power MOS transistor

BLF521

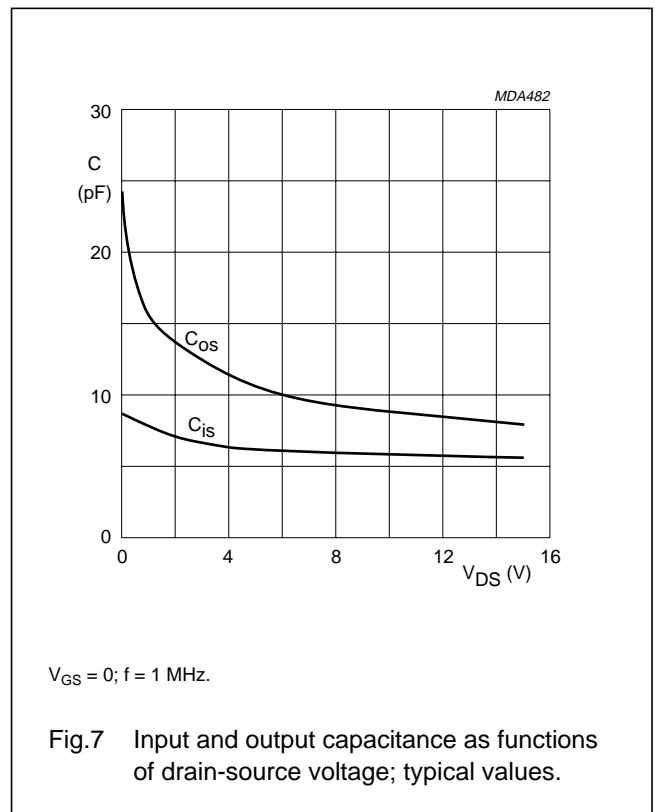
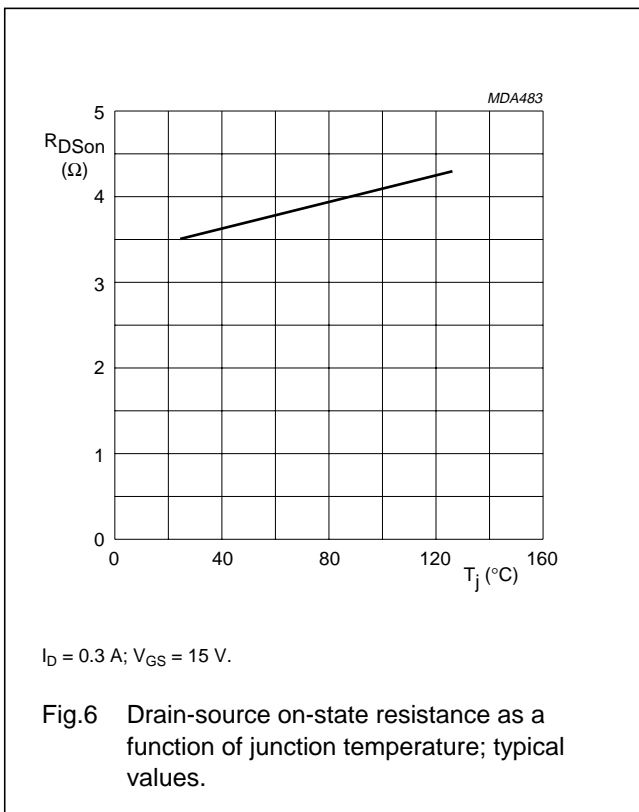
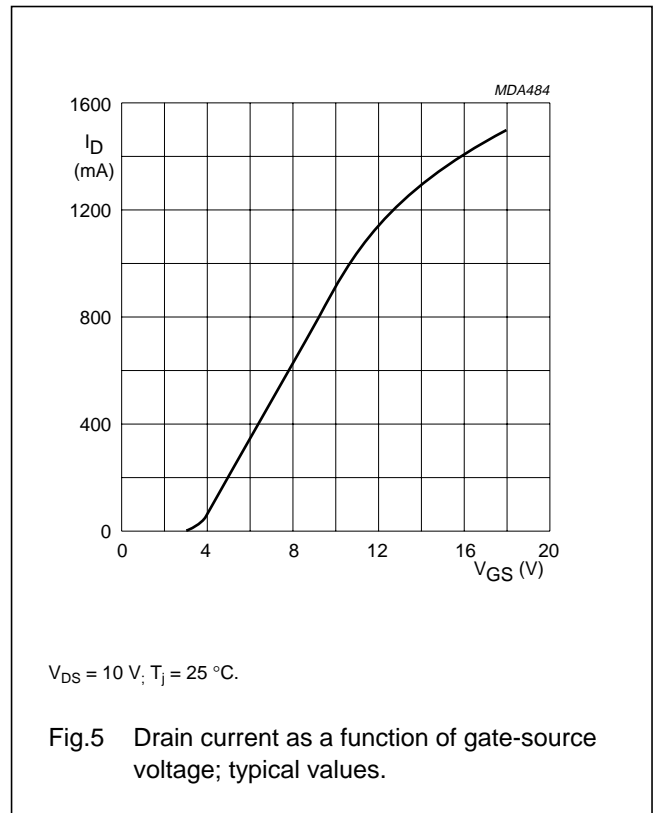
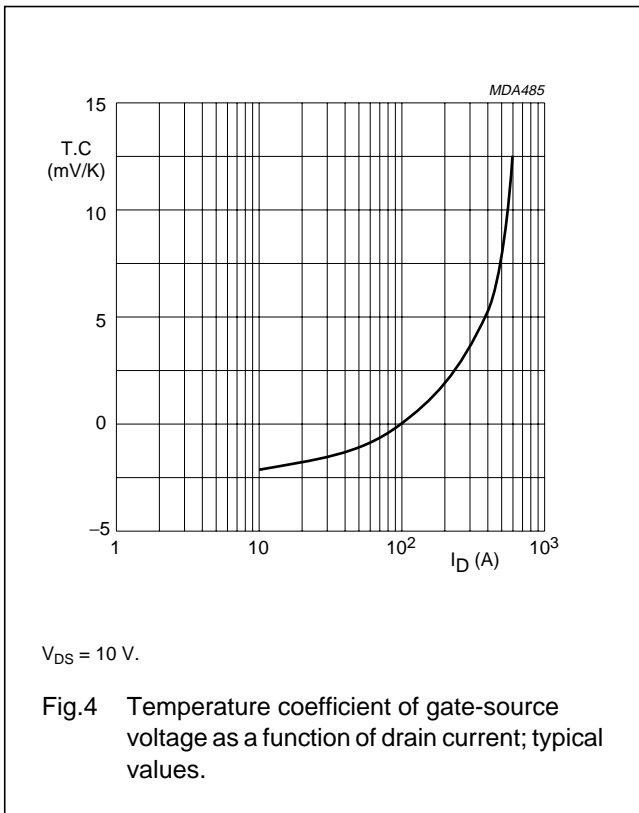

UHF power MOS transistor

BLF521

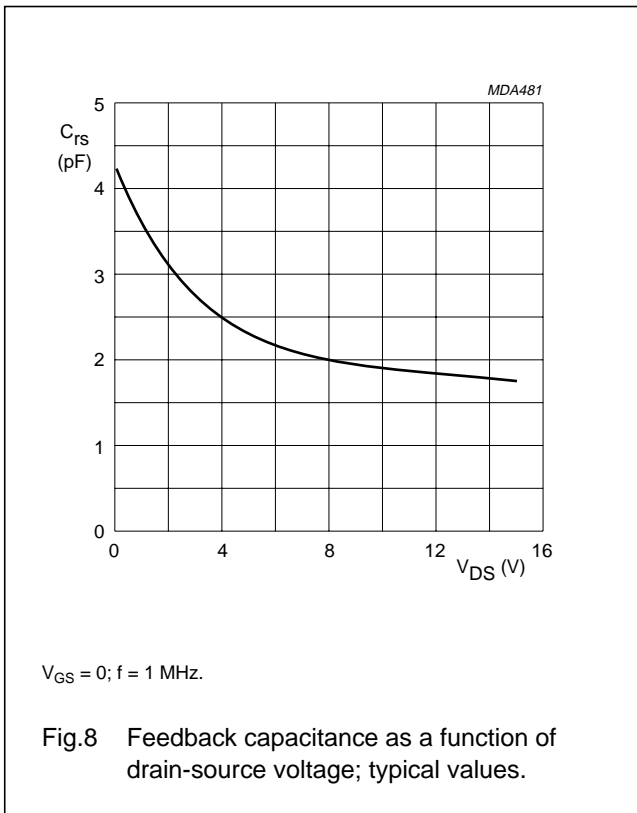

APPLICATION INFORMATION FOR CLASS-B OPERATION

$T_{amb} = 25$ °C; $R_{GS} = 274$ Ω , unless otherwise specified.

RF performance in a common source class-B test circuit.

MODE OF OPERATION	f (MHz)	V_{DS} (V)	I_{DQ} (mA)	P_L (W)	G_p (dB)	η_D (%)
CW, class-B	500	12.5	10	2	> 10 typ. 13	> 50 typ. 60

Ruggedness in class-B operation

The BLF521 is capable of withstanding a load mismatch corresponding to $V_{SWR} = 50:1$ through all phases under the following conditions: $V_{DS} = 15.5$ V; $f = 500$ MHz at rated output power.

UHF power MOS transistor

BLF521

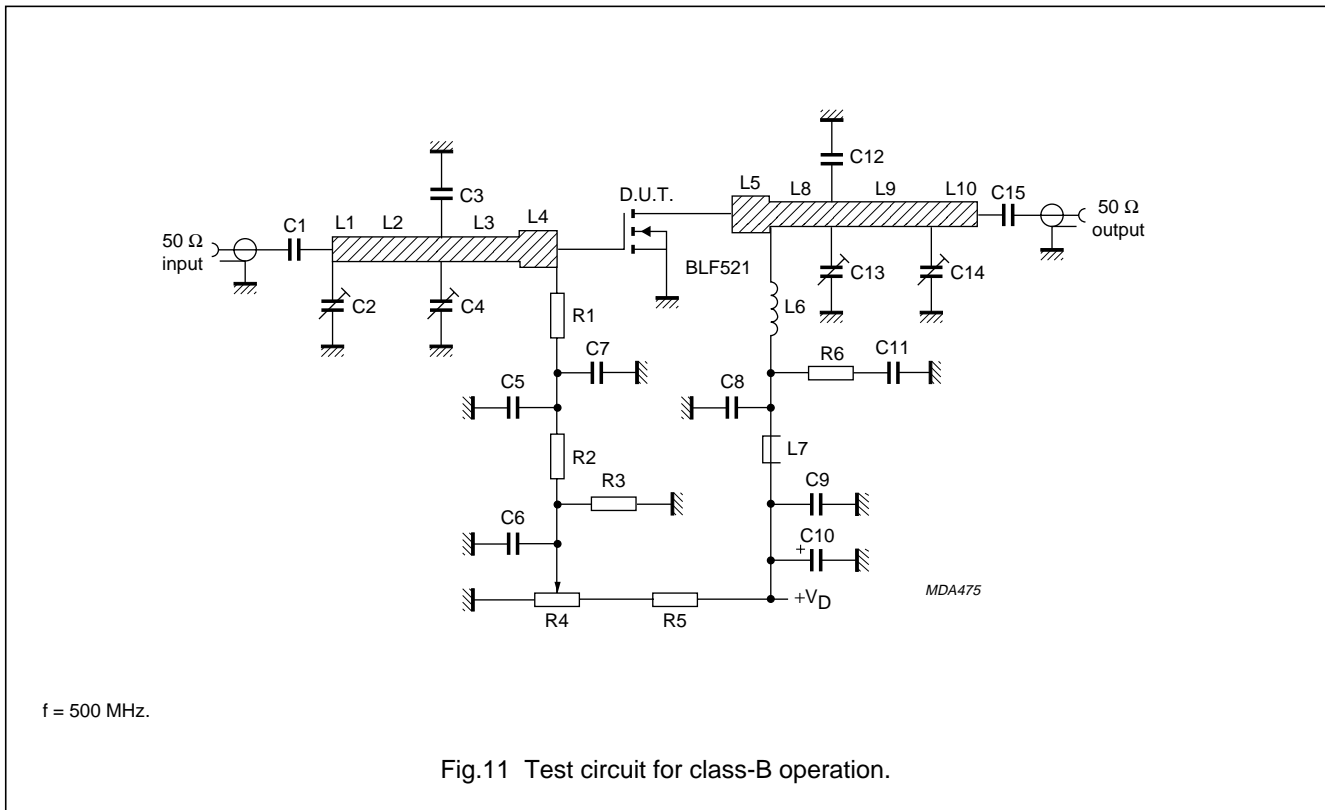
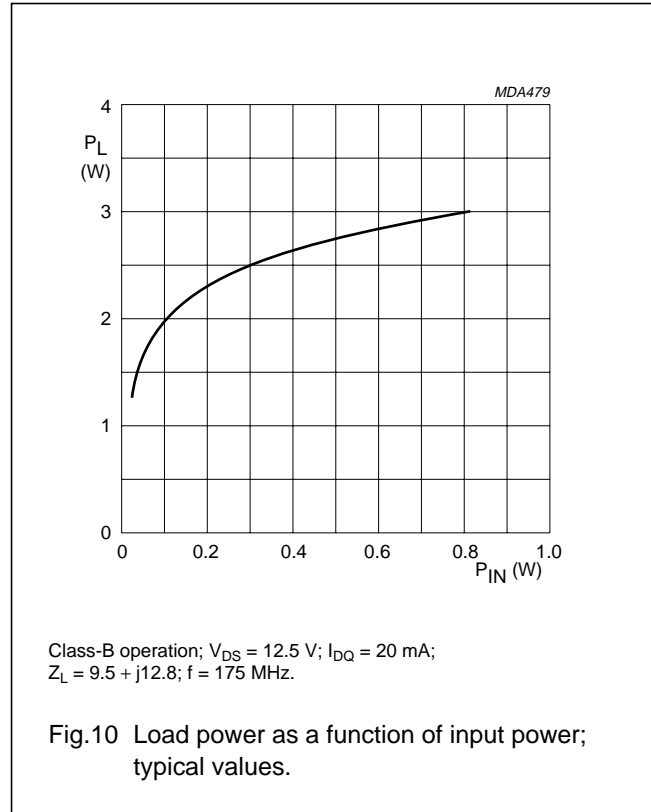
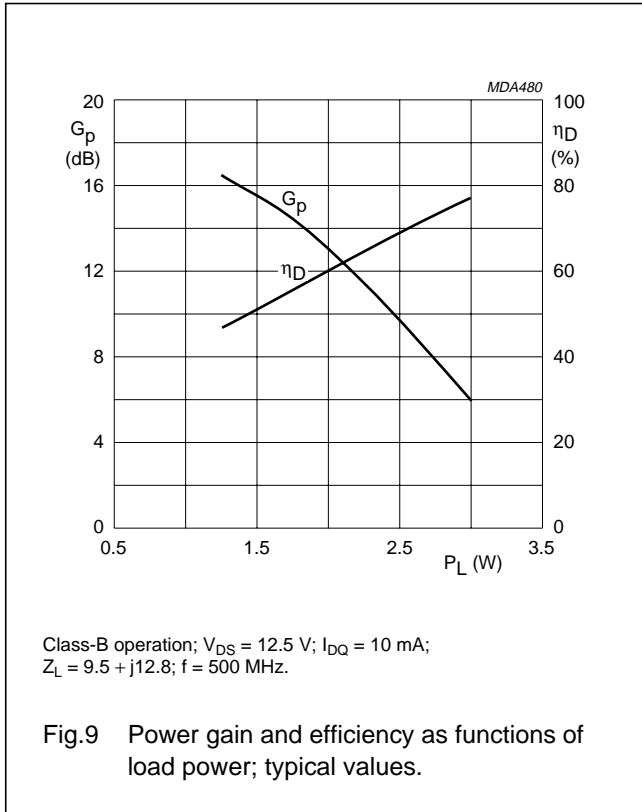

UHF power MOS transistor

BLF521

List of components class-AB test circuit (see Fig.12)

COMPONENT	DESCRIPTION	VALUE	DIMENSIONS	CATALOGUE NO.
C1, C5, C8, C15	multilayer ceramic chip capacitor; note 1	390 pF, 500 V		
C2, C13	film dielectric trimmer	2 to 9 pF		2222 809 09002
C3	multilayer ceramic chip capacitor; note 2	5.6 pF, 500 V		
C4	film dielectric trimmer	2 to 18 pF		2222 809 09003
C6, C11	multilayer ceramic chip capacitor	2 × 100 nF in parallel, 50 V		2222 852 47104
C7, C9	multilayer ceramic chip capacitor	100 nF, 50 V		2222 852 47104
C10	electrolytic capacitor	10 µF, 63 V		2222 030 38109
C12	multilayer ceramic chip capacitor; note 2	9.1 pF, 50 V		
C14	film dielectric trimmer	1.4 to 5.5 pF		2222 809 09001
L1	stripline; note 3	83 Ω	20 × 2 mm	
L2	stripline; note 3	83 Ω	21 × 2 mm	
L3	stripline; note 3	83 Ω	19 × 2 mm	
L4, L5	stripline; note 3	67 Ω	12 × 3 mm	
L6	5 turns enamelled 0.5 mm copper wire	62 nH	length 3.75 mm int. dia. 3 mm leads 2 × 4 mm	
L7	grade 3B Ferroxcube RF choke			4312 020 36642
L8	stripline; note 3	83 Ω	18.6 × 2 mm	
L9	stripline; note 3	83 Ω	31.6 × 2 mm	
L10	stripline; note 3	83 Ω	2 × 2 mm	
R1	0.4 W metal film resistor	274 Ω		2322 151 72741
R2	0.4 W metal film resistor	1.96 kΩ		2322 151 71962
R3	0.4 W metal film resistor	1 MΩ		2322 151 71005
R4	cermet potentiometer	5 kΩ		
R5	0.4 W metal film resistor	7.5 kΩ		2322 151 77502
R6	1 W metal film resistor	10 Ω		2322 153 51009

Notes

1. American Technical Ceramics (ATC) capacitor, type 100B or other capacitor of the same quality.
2. American Technical Ceramics (ATC) capacitor, type 100A or other capacitor of the same quality.
3. The striplines are on a double copper-clad printed-circuit board, with PTFE fibre-glass dielectric ($\epsilon_r = 2.2$), thickness 1.6 mm.

UHF power MOS transistor

BLF521

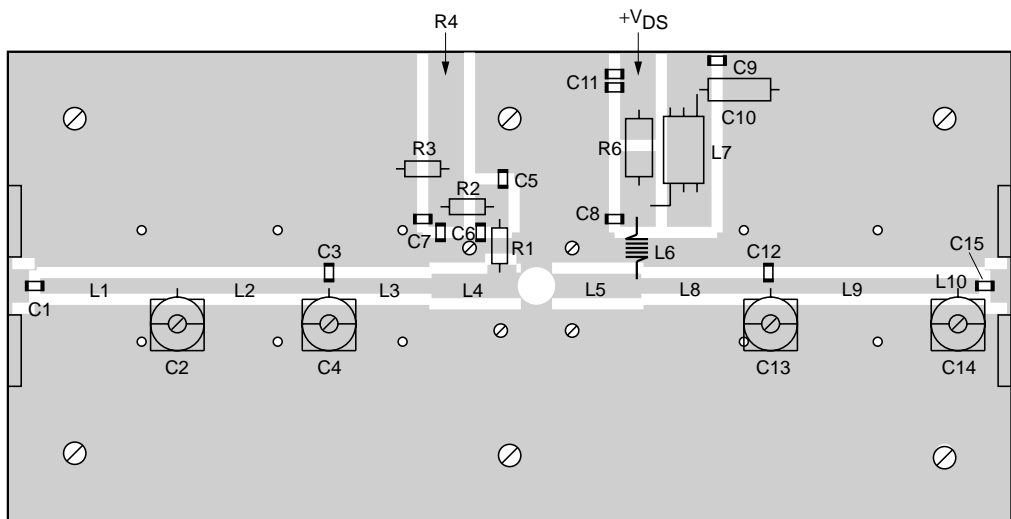

MBA381

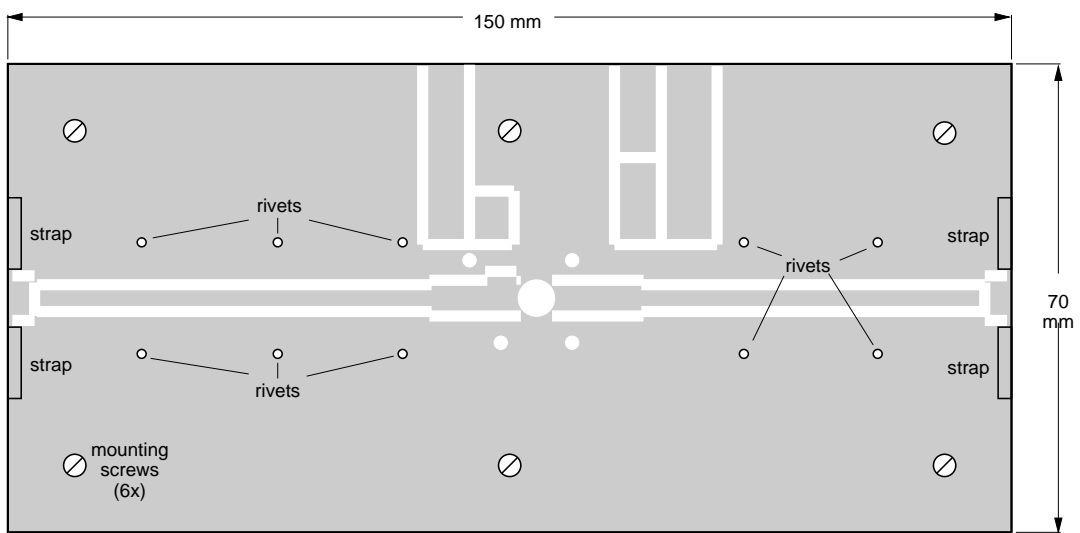

MBA380

The circuit and components are situated on one side of the printed-circuit board, the other side being fully metallized, to serve as a ground plane. Earth connections are made by means of copper straps and hollow rivets for a direct contact between upper and lower sheets.

Fig.12 Component layout for 500 MHz test circuit.

UHF power MOS transistor

BLF521

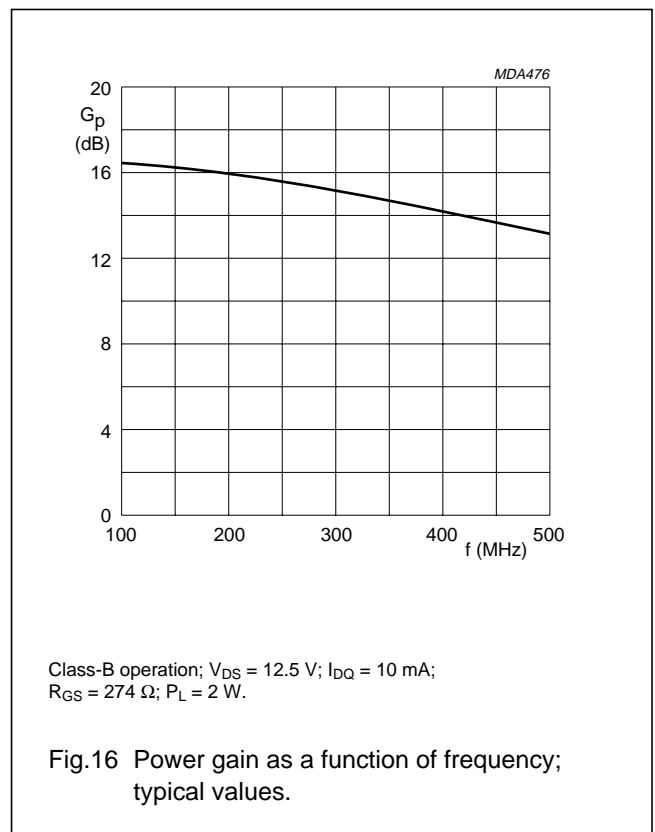
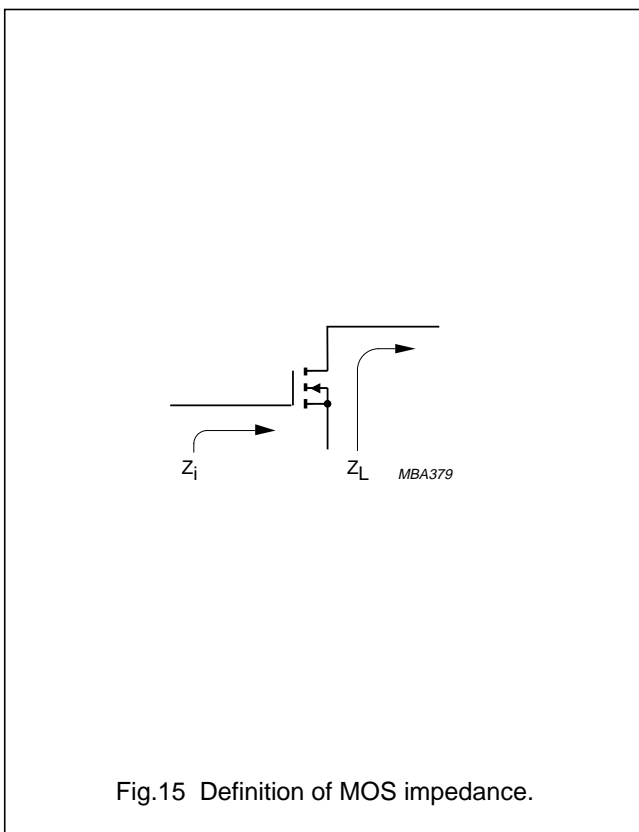
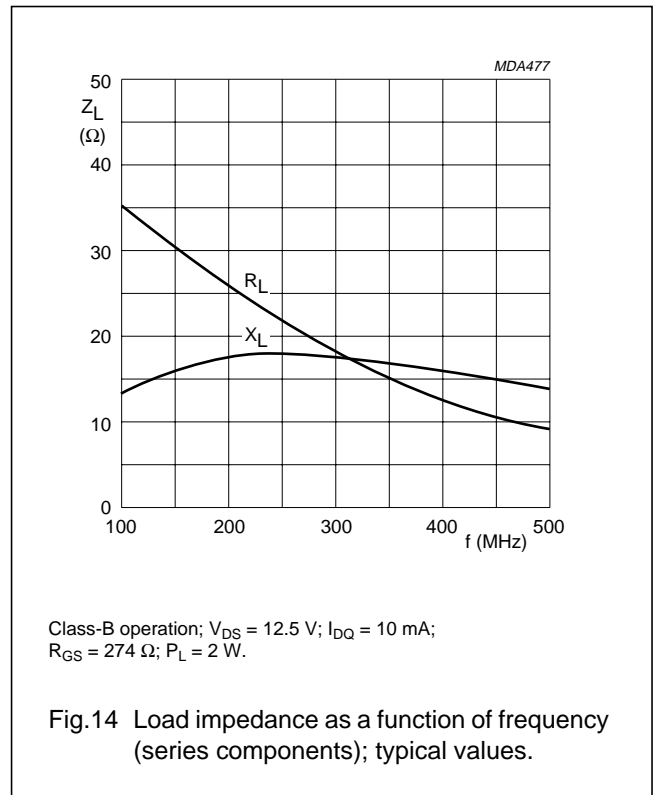
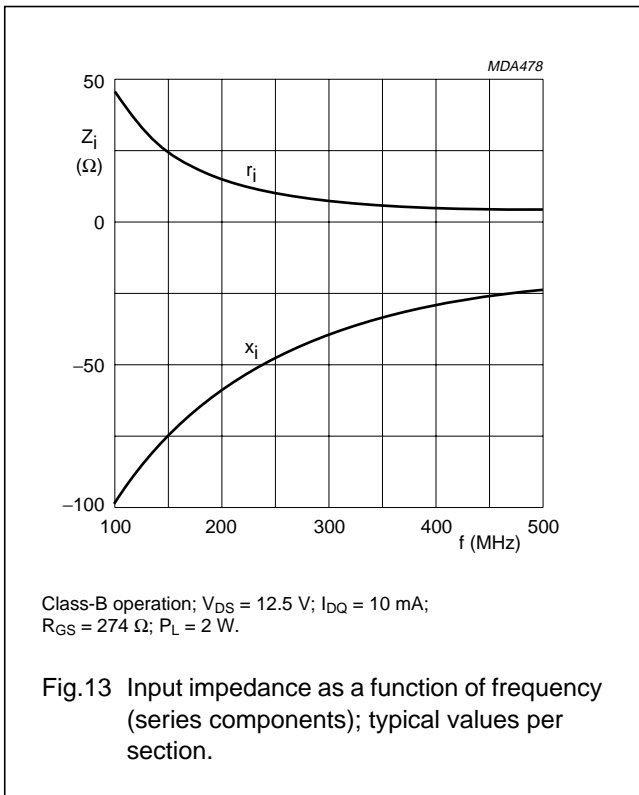

UHF power MOS transistor

BLF521

BLF521 scattering parameters $V_{DS} = 12.5\text{ V}$; $I_D = 10\text{ mA}$.; note 1

f (MHz)	S ₁₁		S ₂₁		S ₁₂		S ₂₂	
	S ₁₁	∠ Φ	S ₂₁	∠ Φ	S ₁₂	∠ Φ	S ₂₂	∠ Φ
5	1.00	-1.6	4.51	178.5	0.01	88.5	0.98	-2.0
10	1.00	-3.2	4.51	177.0	0.01	87.2	0.98	-4.0
20	1.00	-6.4	4.50	173.9	0.02	84.5	0.98	-8.0
30	1.00	-9.6	4.48	170.9	0.03	81.7	0.98	-12.0
40	0.99	-12.8	4.45	167.9	0.04	79.0	0.97	-16.0
50	0.99	-16.0	4.43	164.9	0.05	76.2	0.97	-19.9
60	0.98	-19.1	4.39	161.9	0.06	73.5	0.97	-23.8
70	0.97	-22.1	4.34	158.9	0.07	70.9	0.96	-27.6
80	0.97	-25.1	4.28	156.1	0.08	68.3	0.96	-31.3
90	0.96	-28.0	4.22	153.3	0.08	65.8	0.95	-34.9
100	0.95	-30.9	4.16	150.5	0.09	63.3	0.94	-38.5
125	0.92	-37.9	4.00	144.0	0.11	57.5	0.93	-47.1
150	0.90	-44.3	3.83	137.6	0.13	51.8	0.91	-55.2
175	0.87	-50.4	3.64	131.8	0.14	46.7	0.89	-62.7
200	0.85	-56.0	3.46	126.5	0.15	42.2	0.88	-69.6
250	0.80	-66.2	3.12	116.4	0.17	33.4	0.85	-81.9
300	0.77	-75.1	2.81	108.0	0.18	26.4	0.82	-92.3
350	0.74	-82.9	2.54	100.1	0.19	19.8	0.81	-101.3
400	0.72	-89.7	2.31	93.5	0.19	14.4	0.79	-108.9
450	0.70	-95.9	2.10	87.1	0.19	9.5	0.79	-115.5
500	0.69	-101.5	1.93	81.4	0.19	4.9	0.78	-121.2
600	0.69	-111.3	1.64	71.2	0.19	-2.6	0.78	-130.7
700	0.69	-119.9	1.41	62.2	0.18	-8.7	0.77	-138.5
800	0.69	-127.9	1.23	54.3	0.17	-13.6	0.78	-145.2
900	0.70	-135.1	1.08	47.3	0.15	-17.7	0.78	-151.4
1000	0.72	-142.0	0.97	40.9	0.14	-21.1	0.79	-156.9

Note

- For more extensive s-parameters see internet:
<http://www.semiconductors.philips.com/markets/communications/wirelesscommunication/broadcast>

UHF power MOS transistor

BLF521

PACKAGE OUTLINE

Studless ceramic package; 4 leads

SOT172D

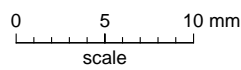
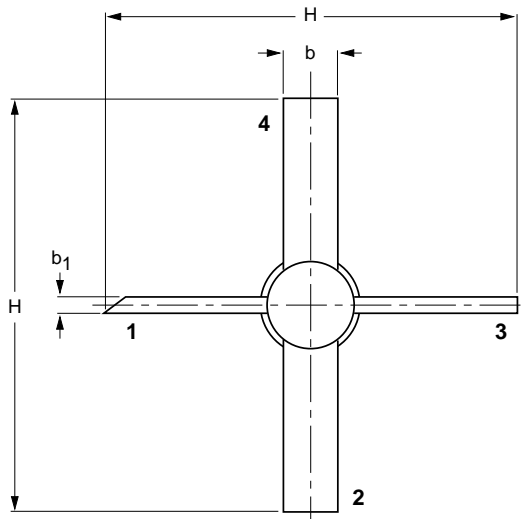
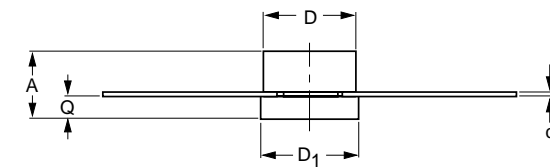

DIMENSIONS (millimetre dimensions are derived from the original inch dimensions)

UNIT	A	b	b ₁	c	D	D ₁	H	Q
mm	3.71	3.31	0.89	0.16	5.20	5.33	26.17	1.15
	2.89	3.04	0.63	0.10	4.95	5.08	24.63	0.88
inches	0.146	0.13	0.035	0.006	0.205	0.210	1.03	0.045
	0.114	0.12	0.025	0.004	0.195	0.200	0.97	0.035

OUTLINE VERSION	REFERENCES				EUROPEAN PROJECTION	ISSUE DATE
	IEC	JEDEC	EIAJ			
SOT172D						97-06-28

UHF power MOS transistor

BLF521

DATA SHEET STATUS

LEVEL	DATA SHEET STATUS ⁽¹⁾	PRODUCT STATUS ⁽²⁾⁽³⁾	DEFINITION
I	Objective data	Development	This data sheet contains data from the objective specification for product development. Philips Semiconductors reserves the right to change the specification in any manner without notice.
II	Preliminary data	Qualification	This data sheet contains data from the preliminary specification. Supplementary data will be published at a later date. Philips Semiconductors reserves the right to change the specification without notice, in order to improve the design and supply the best possible product.
III	Product data	Production	This data sheet contains data from the product specification. Philips Semiconductors reserves the right to make changes at any time in order to improve the design, manufacturing and supply. Relevant changes will be communicated via a Customer Product/Process Change Notification (CPCN).

Notes

1. Please consult the most recently issued data sheet before initiating or completing a design.
2. The product status of the device(s) described in this data sheet may have changed since this data sheet was published. The latest information is available on the Internet at URL <http://www.semiconductors.philips.com>.
3. For data sheets describing multiple type numbers, the highest-level product status determines the data sheet status.

DEFINITIONS

Short-form specification — The data in a short-form specification is extracted from a full data sheet with the same type number and title. For detailed information see the relevant data sheet or data handbook.

Limiting values definition — Limiting values given are in accordance with the Absolute Maximum Rating System (IEC 60134). Stress above one or more of the limiting values may cause permanent damage to the device. These are stress ratings only and operation of the device at these or at any other conditions above those given in the Characteristics sections of the specification is not implied. Exposure to limiting values for extended periods may affect device reliability.

Application information — Applications that are described herein for any of these products are for illustrative purposes only. Philips Semiconductors make no representation or warranty that such applications will be suitable for the specified use without further testing or modification.

DISCLAIMERS

Life support applications — These products are not designed for use in life support appliances, devices, or systems where malfunction of these products can reasonably be expected to result in personal injury. Philips Semiconductors customers using or selling these products for use in such applications do so at their own risk and agree to fully indemnify Philips Semiconductors for any damages resulting from such application.

Right to make changes — Philips Semiconductors reserves the right to make changes in the products - including circuits, standard cells, and/or software - described or contained herein in order to improve design and/or performance. When the product is in full production (status 'Production'), relevant changes will be communicated via a Customer Product/Process Change Notification (CPCN). Philips Semiconductors assumes no responsibility or liability for the use of any of these products, conveys no licence or title under any patent, copyright, or mask work right to these products, and makes no representations or warranties that these products are free from patent, copyright, or mask work right infringement, unless otherwise specified.

Philips Semiconductors – a worldwide company

Contact information

For additional information please visit <http://www.semiconductors.philips.com>. Fax: +31 40 27 24825

For sales offices addresses send e-mail to: sales.addresses@www.semiconductors.philips.com.

© Koninklijke Philips Electronics N.V. 2003

SCA75

All rights are reserved. Reproduction in whole or in part is prohibited without the prior written consent of the copyright owner.

The information presented in this document does not form part of any quotation or contract, is believed to be accurate and reliable and may be changed without notice. No liability will be accepted by the publisher for any consequence of its use. Publication thereof does not convey nor imply any license under patent- or other industrial or intellectual property rights.

Printed in The Netherlands

613524/05/pp14

Date of release: 2003 Sep 02

Document order number: 9397 750 11587

Let's make things better.

**Philips
Semiconductors**



PHILIPS