

ISL6442 Dual PWM and Linear Controller Evaluation Board User Guide

This application note describes how to use the ISL6442EVAL1Z (Rev. C) board to evaluate the ISL6442 dual switching regulator, plus one linear regulator. Refer to the schematic, BOM (Bill of Materials), and board layout (at the end of this document), as needed. The [ISL6442 datasheet](#) is also used as a reference.

Configuration

The outputs are set up as follows:

- Switcher $V_{OUT1} = 1.8V @ 3A$ (with $V_{IN} = 6V$)
- Switcher $V_{OUT2} = 3.3V @ 3A$ (with $V_{IN} = 6V$)
- Linear $V_{OUT3} = 5.0V @ 0.3A$ (with $V_{IN3} = 6V$)

The outputs are switching at $\sim 1.4MHz$ rate, based on the resistor selected on the RT pin.

The current range for the switcher output that is presently supported is limited by the FETs used. The FDS6912A dual FET (in SO-8 package) can handle up to 3A. However, the ISL6442 gate drivers are capable of driving discrete upper and lower FETs for up to 25A output current as well, even though not supported on this board.

The linear output supports $\sim 1W$. The output current capability of the linear regulator is determined mainly by the power dissipation of the FET as mounted:

$$P_{V_{OUT3}} = (V_{IN3} - V_{OUT3}) * I_{OUT3}$$

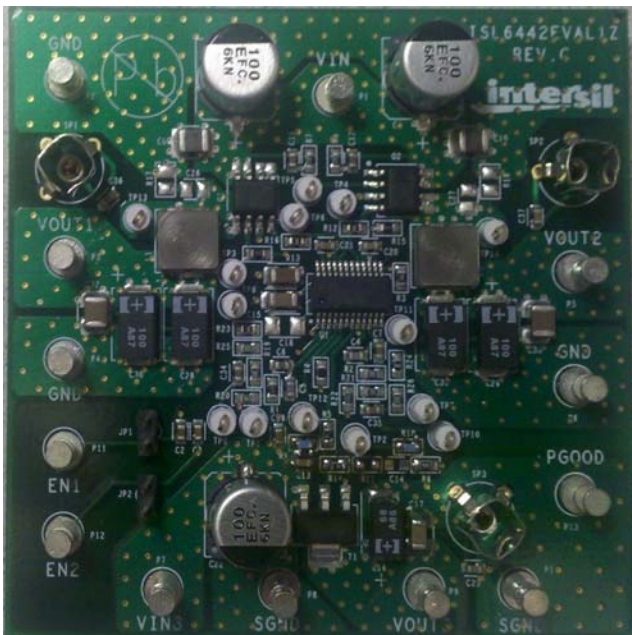

FIGURE 1. ISL6442EVAL1Z BOARD PHOTO

Quick Start Evaluation

Figure 1 shows a photo of the populated board, and Figure 2 shows a plot of the top layer for reference, and details the available input and output connections. Two switchers share one input V_{IN} . The linear regulator has separate turrets for its input (V_{IN3}) and GND. Each output has turrets for V_{OUT} and GND, plus a scope probe socket, for low noise waveforms.

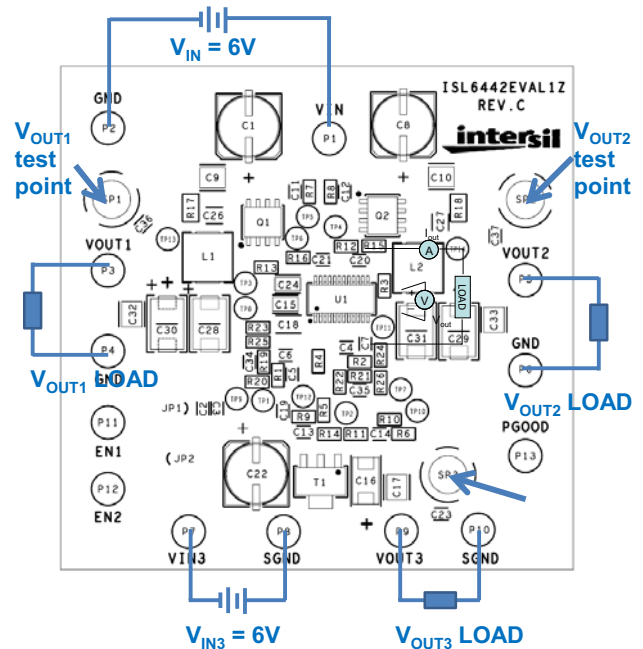

FIGURE 2. ISL6442EVAL1Z INPUT AND OUTPUT CONNECTIONS

Quick Start Setup (Light Load)

For a quick and easy test, one 6V supply is needed. Connect P1 (V_{IN}) and P7 (V_{IN3}) to each other, and to the 6V supply; connect the supply GND to P2 and P9. Attach light loads to each output.

Switch on the power supply; all three outputs should turn on to their expected DC values; use a voltmeter or oscilloscope to view them. V_{OUT1} and V_{OUT2} will have a ramp time of a few milliseconds (V_{OUT3} will be much faster).

Note that the IC and all three inputs are sharing one supply voltage in this simple example. The linear V_{IN3} can certainly be different, since it has its own input posts.

Board Features and Modifications

Heavier loads can be evaluated by placing them across the appropriate output to GND. Resistors, electronic loads, or

Application Note 1181

actual loads can be used. It is **STRONGLY** recommended that the power be turned off when attaching loads, due to the tight spacing of the posts. The switcher outputs should be able to provide at least 3A; monitor the FET temperature if you try to go higher, to be sure the conditions will allow it. Make sure the input power supply can source the amount of input current necessary to drive the maximum loads to be tested.

The linear VOUT3 is especially sensitive to power dissipation concerns; it will change as the user varies either the input voltage, the output voltage, and/or the load current. The equation used is $P_{VOUT3} = (V_{IN3} - V_{OUT3}) * I_{OUT3}$. The PNP bipolar will also be rated for how well the power is dissipated from the package and spread out on the board; this is another variable that the user must keep in mind for their design and layout.

JP1 is used to disable VOUT1, by shorting SS/EN1 to GND. JP2 does the same function for VOUT2.

The switching frequency is controlled by a resistor (R4) on the RT pin, to GND. Refer to the datasheet for the curve of resistor values versus frequency.

Each output voltage is determined by a resistor divider from the output to its FB pin to GND. See the [ISL6442 datasheet](#) for the formulas to calculate the values. Note that there are some limitations; the switchers can approach 100% duty, but will be limited by dead time, $r_{DS(on)}$ of the FETs at maximum load, switching frequency, etc. The maximum values are limited by the VIN available (if you want go higher, check the ratings of the FETs, and other output components to be sure they can handle it). The minimum output voltage will be just above the 0.6V internal reference. The maximum output voltage for the linear is limited by the VIN3 and the LCDR pin (which is biased from 5V). Thus, the maximum output voltage is close to the 5V set on the board; it is not recommended to go higher. The minimum voltage will also be just above the 0.6V internal reference.

Performance Waveforms

These figures depict the ISL6442EVAL1Z performance during typical operational situations, as well as during fault conditions. Loading of the output can be most easily done via an electronic load; however, other methods can work as well.

Figure 3 shows a typical power-up sequence, with all inputs connected to a single VIN = VIN3 = 6V. When VCC exceeds its POR rising trip point (~4.4V), the IC is enabled, and the linear VOUT3 comes up almost immediately. Meanwhile, the two SS/EN pins start charging (not shown), but the outputs do not start ramping until the SS/EN pins ~1V; then both switcher outputs

start their soft-start ramps at the same time. In this case, both outputs track each other initially; this is accomplished by selecting the ratio of SS/EN capacitors to match their output voltages. The ramp times shown are on the order of a few milliseconds, as determined by the SS/EN capacitors on the board.

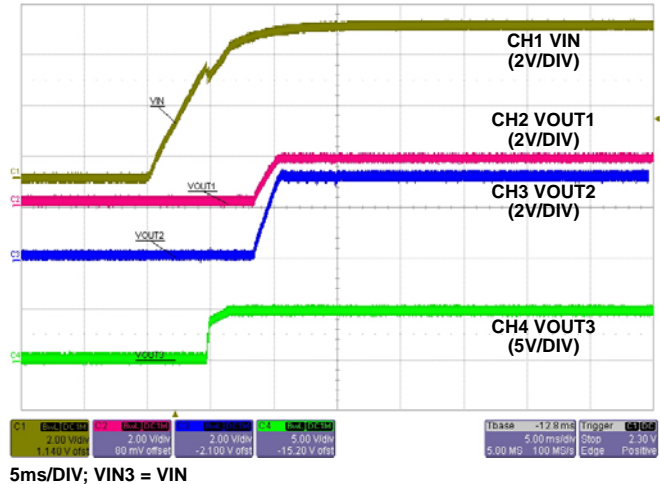

FIGURE 3. TYPICAL POWER-UP WAVEFORMS WITH VIN

Figure 4 shows the detail soft start waveform of PWM1 (PWM2 would be similar). The full SS/EN1 ramp is shown; the output doesn't start to ramp until the SS/EN passes the ~1V threshold for Enable. The output ramps from zero to full scale, while SS/EN1 ramps from 1.0V to 1.6V. Finally, the EN/SS1 keeps ramping up to ~3.2V, at which point the ramp is considered done (the PGOOD timer would start from this point, if both outputs ramps were done).

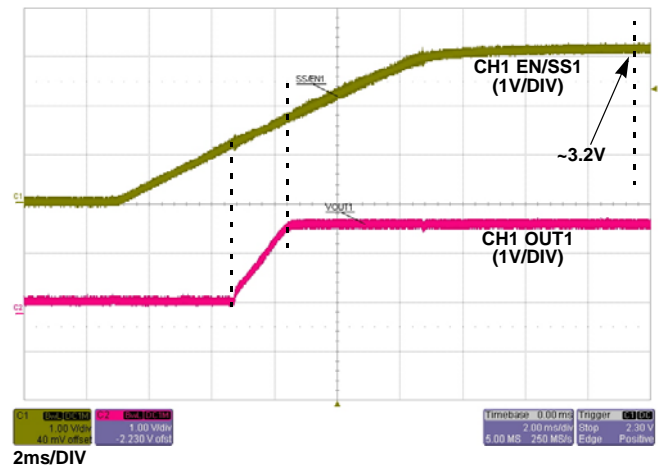

FIGURE 4. PWM1 SOFT-START

Application Note 1181

Figures 5 and 6 show the PHASE1 signal (which has the same timing as UGATE1) and the output voltage ripple on VOUT1 at no load and 3A load. The switching frequency is 1.4 MHz.

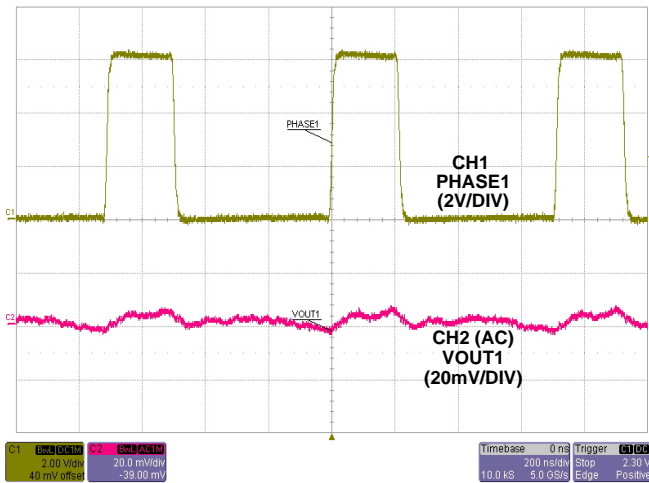

FIGURE 5. PWM1 SWITCHING AND RIPPLE WAVEFORMS AT NO LOAD

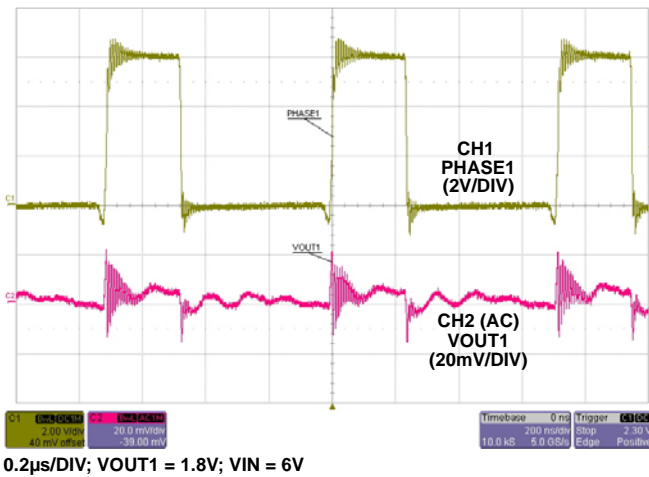

FIGURE 6. PWM1 SWITCHING AND RIPPLE WAVEFORMS AT 3A LOAD

Figure 7 shows the overcurrent hiccup mode already in operation. At time T0, the SS/EN2 is discharged to GND (it may not have time to reach GND, due to the limited size of the discharge transistor, plus the size of the timing capacitor). Once SS/EN2 is below ~1V, the output should shut off, and the load current goes to zero; this occurs by time T1. Once SS/EN2 rises above 1V again, the VOUT2 will try to turn on again. If the output remains shorted, the output current will be limited on each clock cycle to an average value low enough to keep the dissipation reasonable.

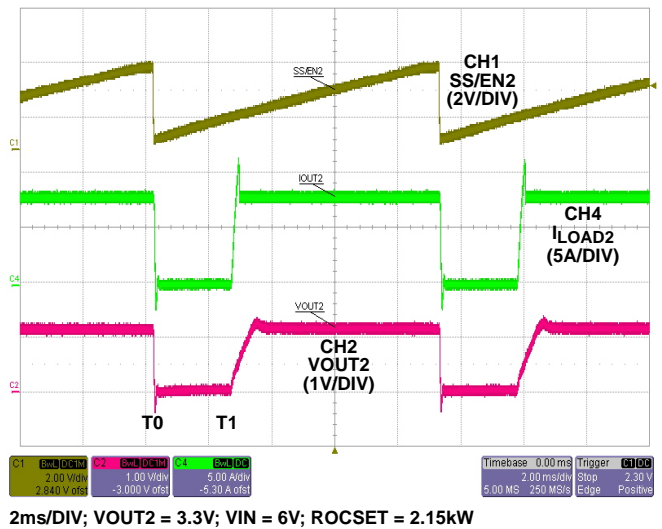

FIGURE 7. PWM2 OVERCURRENT HICCUP MODE

Conclusion

The ISL6442EVAL1Z evaluation board showcases a simple, but high-performance dual regulator, providing control in a variety of applications, with emphasis on computer systems. The high-current MOSFET drivers of the ISL6442 yield a highly efficient power conversion solution with a reduced number of external components in a compact footprint.

Documentation

See the following pages for more detailed information, including:

- “Schematic” of ISL6442EVAL1Z
- Table 1, “BILL OF MATERIALS” on page 5
- “ISL6442EVAL1Z Board Layout” on page 7. Note that this board layout has not been fully optimized for performance or minimum board area, primarily due to the various options, test points, and other features to make testing easier. So while it follows most of the recommended practices, it could potentially be improved for any given single application.

References

Datasheet: [ISL6442 datasheet](#)

Visit us on the internet, at: <http://www.intersil.com>

Schematic

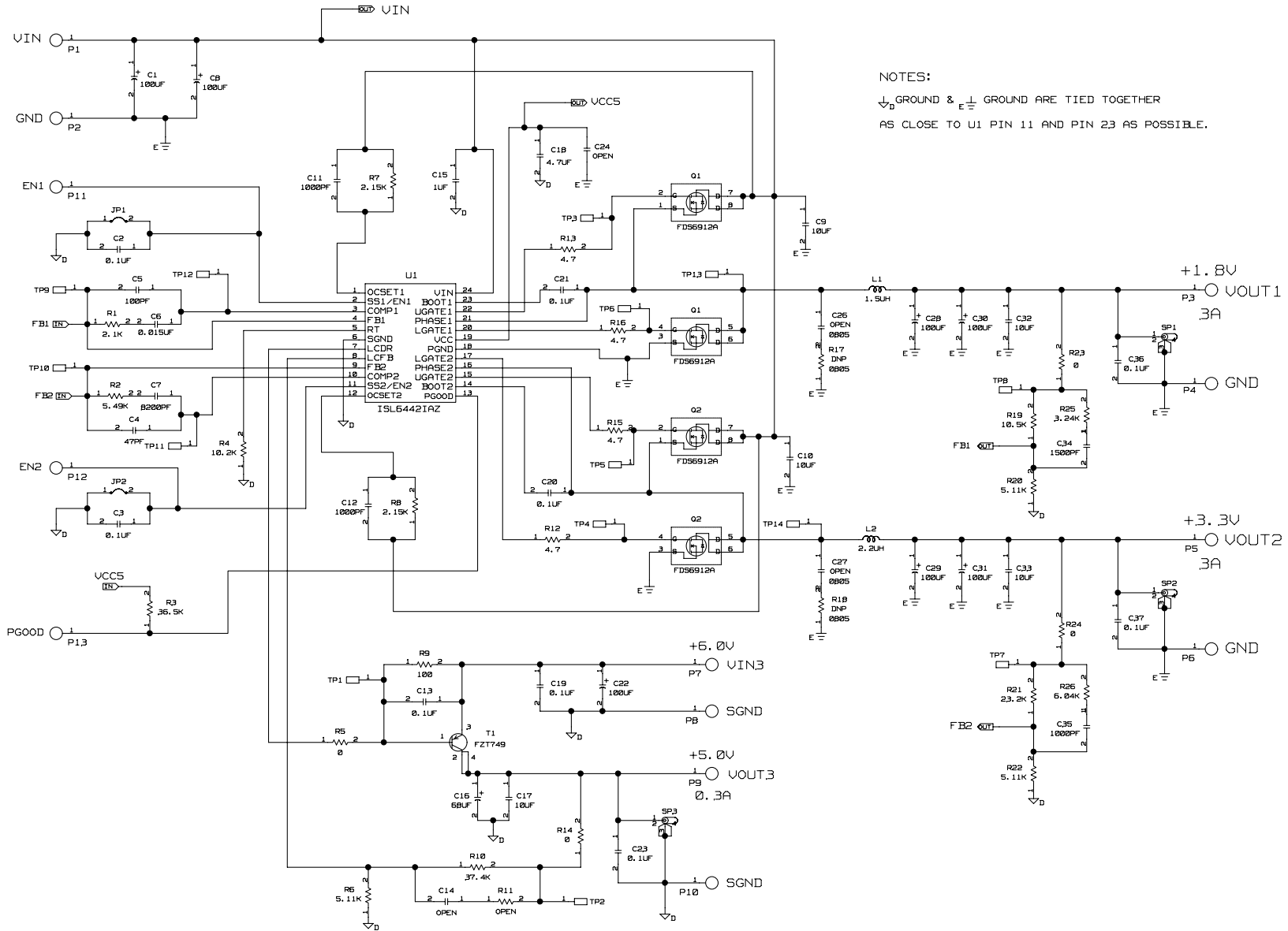

NOTES:

- ⏚ GROUND & E_⏚ GROUND ARE TIED TOGETHER
- AS CLOSE TO U1 PIN 11 AND PIN 23 AS POSSIBLE.

Application Note 1181

TABLE 1. BILL OF MATERIALS

ITEM	QTY	PART REFERENCE	VALUE	DESCRIPTION	PART #	MANUFACTURER
1	4	C28-C31	100μF	CAP-TANT LOWESR, SMD, D3, 100μF, 10V, 20%, POSCAP, ROHS	10TPB100M	SANYO
2	1	C16	68μF	CAP, SMD, 6x3.2, 68μF, 10V, 20% POSCAP, ROHS	10TPB68MC	SANYO
3	4	C2, C3, C13, C19	0.1μF	CAPACITOR, SMD, 0603, 0.1μF, 50V, 10%, X7R		Generic
4	1	C18	4.7μF	CAPACITOR, SMD, 1206, 4.7μF, 16V, 10%, X7R, ROHS		Generic
5	3	C17, C32, C33	10μF	CAP, SMD, 1210, 10μF, 25V, 20%, X7R, ROHS		Generic
6	3	C1, C8, C22	100μF	CAP, SMD, 8X10.2, 100μF, 25V, 20%, AL,EL, ROHS	EEE-FC1E101P	EEE-FC1E101P
7	2	C9, C10	10μF	CAP, SMD, 1210, 10μF, 35V, 10%, X5R, ROHS		Generic
8	1	C5	100pF	CAP, SMD, 0603, 100pF, 50V, 5%, COG, ROHS		Generic
9	3	C11, C12, C35	1000pF	CAP, SMD, 0603, 1000pF, 50V, 10%, X7R, ROHS		Generic
10	5	C20, C21, C23, C36, C37	0.1μF	CAP, SMD, 0603, 0.1μF, 25V, 10%, X7R, ROHS		Generic
11	1	C34	1500pF	CAP, SMD, 0603, 1500pF, 50V, 10%, X7R, ROHS		Generic
12	1	C6	15nF	CAP, SMD, 0603, .015μF, 50V, 10%, X7R, ROHS		Generic
13	1	C4	47pF	CAP, SMD, 0603, 47pF, 50V, 5%, NPO, ROHS		Generic
14	1	C7	8200pF	CAP, SMD, 0603, 8200pF, 50V, 10%, X7R, ROHS		Generic
15	1	C15	1μF	CAP, SMD, 1206, 1μF, 50V, 10%, X7R, ROHS		Generic
16	1	L1	1.5μH	COIL-PWR INDUCTOR, SMD, 6.9x6.5m, 1.5μH, 20%, 9A, ROHS	IHLP-2525CZ-ER-1R5-M01	IHLP-2525CZ-ER-1R5-M01
17	1	L2	2.2μH	COIL-PWR INDUCTOR, SMD, 6.9x6.5m, 2.2μH, 20%, 10A, ROHS	IHLP-2525CZ-ER-2R2-M01	IHLP-2525CZ-ER-2R2-M01
18	3	SP1-SP3		CONN-SCOPE PROBE TEST PT, COMPACT, PCB MNT, ROHS	131-4353-00	131-4353-00
19	13	P1-P13		CONN-TURRET, TERMINAL POST, TH, ROHS	1514-2	1514-2
20	14	TP1-TP14		CONN-MINI TEST POINT, VERTICAL, WHITE, ROHS	5002	5002
21	2	JP1, JP2		CONN-JUMPER, 2PIN, SHUNT, ROHS	SPC02SYAN	SPC02SYAN
22	1	U1		IC-PWM/LINEAR CONTROLLER, 24P, QSOP, ROHS	ISL6442IAZ	ISL6442IAZ
23	2	Q1, Q2		TRANSIST-DUAL MOS, N-CHAN, 8P, SOIC, 30V, 6A, ROHS	FDS6912A	FDS6912A
24	1	T1		TRANSISTOR, PNP, SMD, SOT223, -25V, -3A, ROHS	FZT749	FZT749
25	4	R12, R13, R15, R16	4.7Ω	RES, SMD, 0603, 4.7Ω, 1/10W, 1%, TF, ROHS		Generic

Application Note 1181

TABLE 1. BILL OF MATERIALS (Continued)

ITEM	QTY	PART REFERENCE	VALUE	DESCRIPTION	PART #	MANUFACTURER
26	4	R5, R14, R23, R24	0Ω	RESISTOR, SMD, 0603, 0Ω, 1/10W, TF, ROHS		Generic
27	1	R9	100Ω	RES, SMD, 0603, 100Ω, 1/10W, 1%, TF, ROHS		Generic
28	1	R4	10.2kΩ	RES, SMD, 0603, 10.2k, 1/10W, 1%, TF, ROHS		Generic
29	1	R19	10.5kΩ	RES, SMD, 0603, 10.5k, 1/10W, 1%, TF, ROHS		Generic
30	1	R1	2.1kΩ	RES, SMD, 0603, 2.1k, 1/10W, 1%, TF, ROHS		Generic
31	2	R7, R8	2.15kΩ	RES, SMD, 0603, 2.15k, 1/10W, 1%, TF, ROHS		Generic
32	1	R21	23.2kΩ	RES, SMD, 0603, 23.2k, 1/10W, 1%, TF, ROHS		Generic
33	1	R25	3.24kΩ	RES, SMD, 0603, 3.24k, 1/10W, 1%, TF, ROHS		Generic
34	1	R3	36.5kΩ	RES, SMD, 0603, 36.5k, 1/10W, 1%, TF, ROHS		Generic
35	1	R10	37.4kΩ	RES, SMD, 0603, 37.4k, 1/10W, 1%, TF, ROHS		Generic
36	3	R6, R20, R22	5.11kΩ	RES, SMD, 0603, 5.11k, 1/10W, 1%, TF, ROHS		Generic
37	1	R2	5.49kΩ	RES, SMD, 0603, 5.49k, 1/10W, 1%, TF, ROHS		Generic
38	1	R26	6.04kΩ	RES, SMD, 0603, 6.04k, 1/10W, 1%, TF, ROHS		Generic

ISL6442EVAL1Z Board Layout

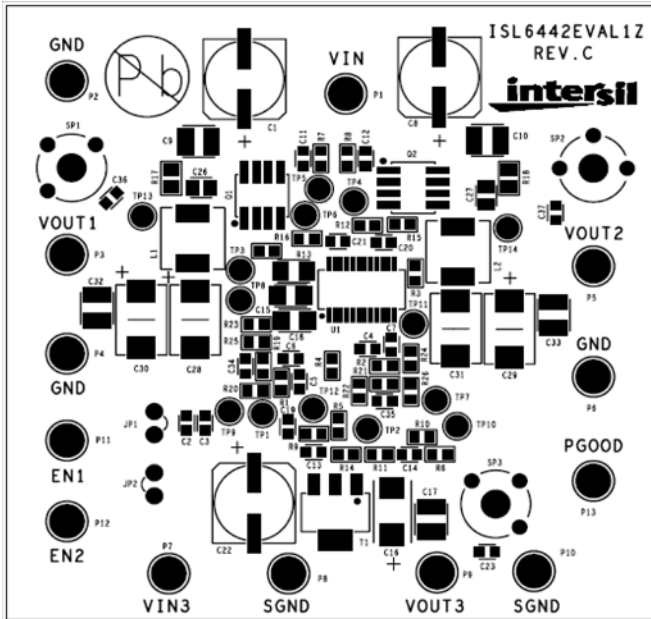

FIGURE 8. TOP SILKSCREEN

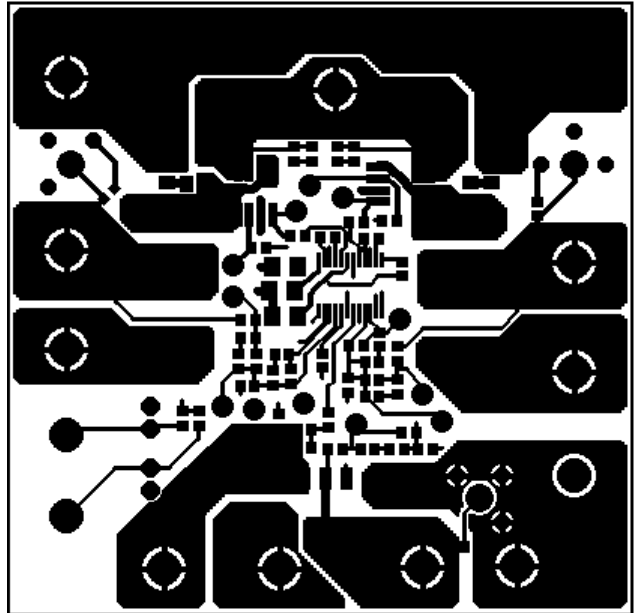

FIGURE 9. TOP LAYER

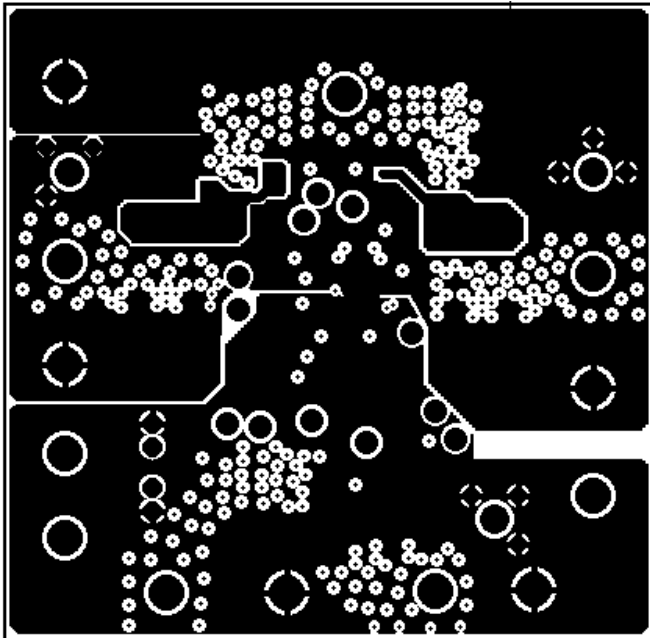

FIGURE 10. 2ND LAYER

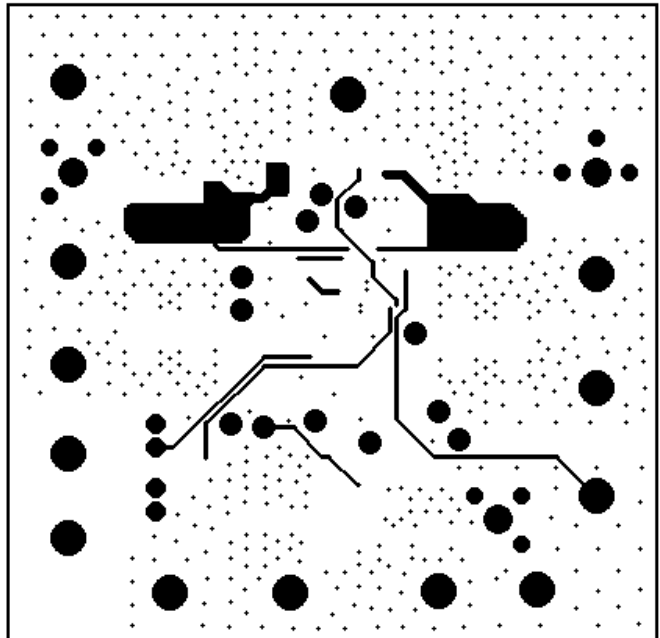

FIGURE 11. 3RD LAYER

ISL6442EVAL1Z Board Layout (Continued)

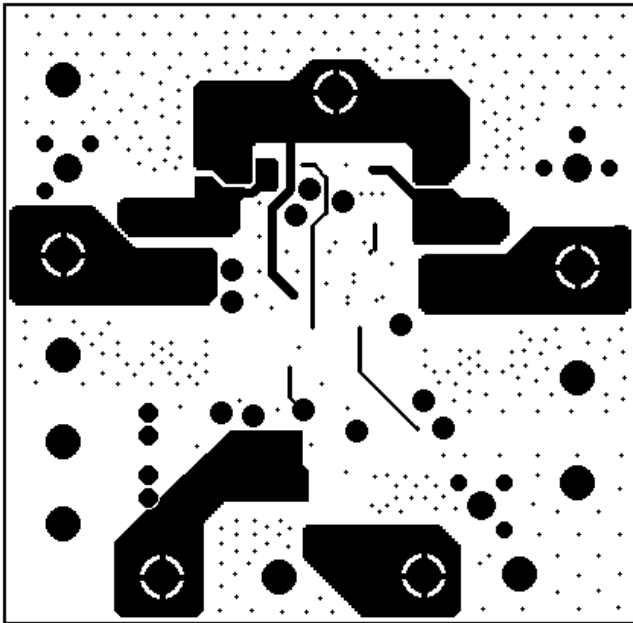

FIGURE 12. BOTTOM LAYER

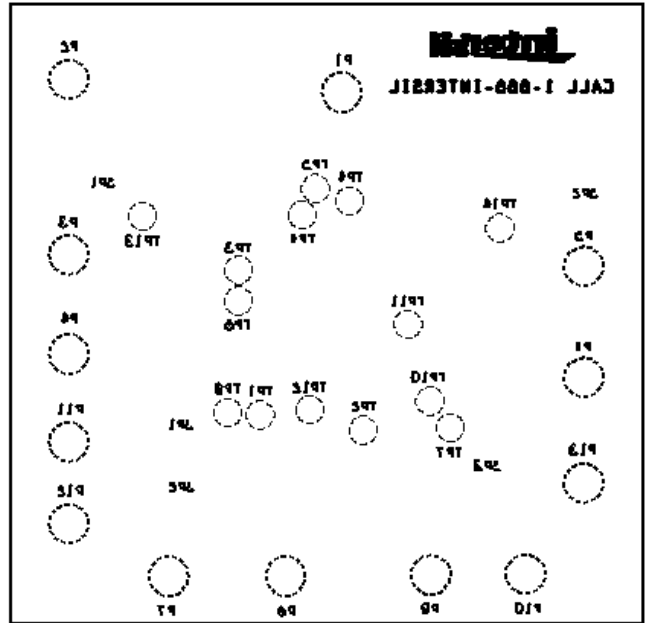

FIGURE 13. BOTTOM SILKSCREEN

Intersil Corporation reserves the right to make changes in circuit design, software and/or specifications at any time without notice. Accordingly, the reader is cautioned to verify that the Application Note or Technical Brief is current before proceeding.

For information regarding Intersil Corporation and its products, see www.intersil.com