

Sensitivity Wavelength Range: 800nm ~ 1750nm

The 1346 series from Marktech, a high sensitivity and high reliability product series, is ideally suited for Optical Communication devices. Custom packaging options for this die are also available.

FEATURES

- > High Speed Response (Max: 1Gbps)
- > TO-46 Metal Can Package
- > Active Area of 0.8mm / High Sensitivity
- > Spectral Range 800nm -- 1750nm

APPLICATIONS

- > High Speed Optical Communications
- > Optical LAN
- > Optical Switches
- > Ethernet Fiber Channel

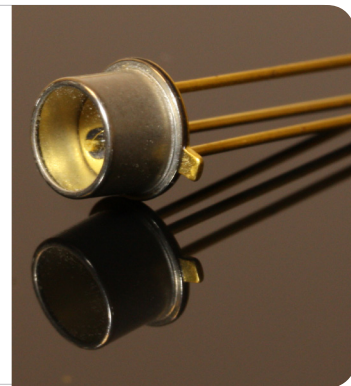

Absolute Maximum Ratings (Ta=25°C)

ITEMS	SYMBOL	RATINGS	UNIT
Active Area	Φ	0.8	mm
Operating Temperature Range	Topr	-40 ~ +85	°C
Storage Temperature Range	Tstg	-40 ~ +125	°C

Electrical & Optical Characteristics (Ta = 25°C)

ITEMS	SYMBOL	CONDITIONS	MIN	TYP	MAX	UNIT
Breakdown Voltage	VR	IR=10μA	5	--	--	V
Sensitivity Range	λ	VR=0V	800	--	1750	nm
Dark Current	ID	VR=2V	--	--	2.0	μA
Junction Capacitance	Cj	VR=0V	--	45	--	pF
Photo Current at 1300nm *1	IL	*2	--	130	--	μA

*1: As mounted on TO-46 gold header without resin coating. *2, VR=5V, Ee=1mW/cm²

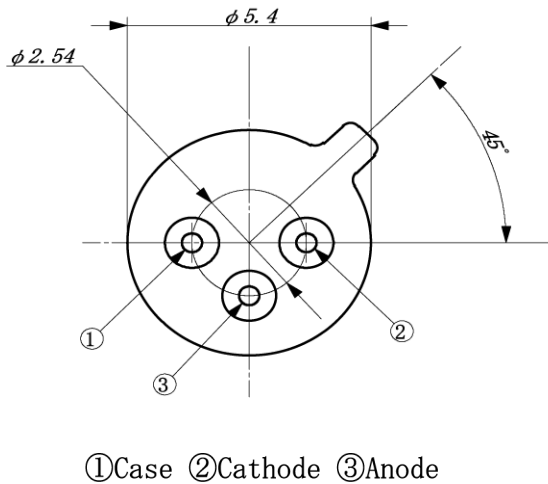
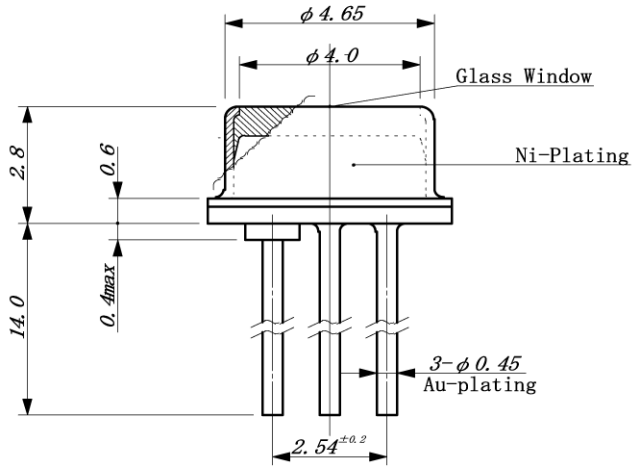

Unit: mm, Tolerance: ± 0.2

The information contained herein is subject to change without notice.

2015-12-01