

## Ultra Low Power, 14V, 200mA Low-Dropout Linear Regulator

### General Description

The RT9064 is a low-dropout (LDO) linear regulator that features high input voltage, low dropout voltage, ultra-low operating current, and miniaturized packaging. With quiescent current as low as 2 $\mu$ A, the RT9064 is ideal for battery-powered equipment.

The RT9064's stability requirements are easily met with all types of output capacitors, including tiny ceramic capacitors, over its wide input range (3.5V to 14V) and its load current range (0mA to 200mA). The RT9064 offers standard output voltages of 2.5V, 3.3V and 5V.

### Pin Configurations

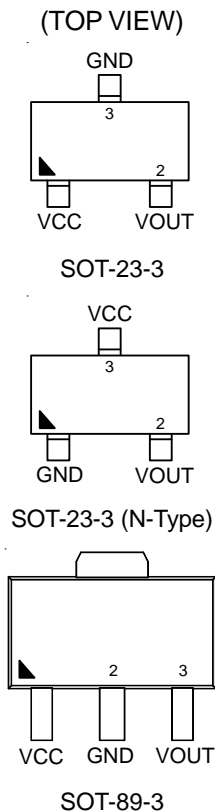

### Features

- 2 $\mu$ A Quiescent Current
- $\pm$ 2% Output Accuracy
- 200mA Output Current
- 14V Maximum Operating Input Voltage
- Dropout Voltage : 0.4V at 100mA
- Fixed Output Voltage : 2.5V/3.3V/5V
- Stable with Ceramic or Tantalum Capacitor
- Current Limit Protection
- Over-Temperature Protection
- SOT-23-3, SOT-89-3 Packages
- RoHS Compliant and Halogen Free

### Applications

- Portable, Battery Powered Equipment
- Ultra Low Power Microcontrollers

### Ordering and Marking Information

Part Number	Output Voltage	Package	Marking Information
RT9064-25GV	2.5V	SOT-23-3	0D=
RT9064-25GVN		SOT-23-3 (N)	30=
RT9064-25GX		SOT-89-3	04=
RT9064-33GV	3.3V	SOT-23-3	0E=
RT9064-33GVN		SOT-23-3 (N)	2Z=
RT9064-33GX		SOT-89-3	05=
RT9064-50GV	5.0V	SOT-23-3	0F=
RT9064-50GVN		SOT-23-3 (N)	2Y=
RT9064-50GX		SOT-89-3	06=

### Simplified Application Circuit

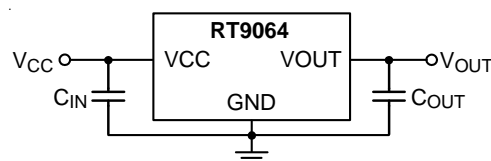

Functional Pin Description

Pin No.			Pin Name	Pin Function
SOT-23-3	SOT-23-3 (N-Type)	SOT-89-3		
1	3	1	VCC	Supply Voltage Input.
2	2	3	VOUT	Output of the Regulator.
3	1	2	GND	Ground.

Function Block Diagram

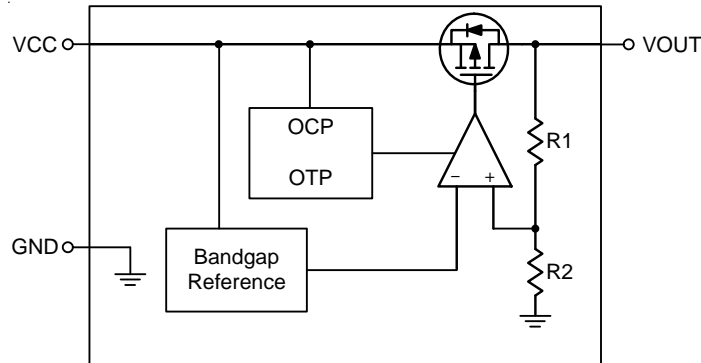

Operation

The RT9064 is a high input voltage linear regulator specifically designed to minimize external components.

The minimum required output capacitance for stable operation is 1µF effective capacitance after consideration of the temperature and voltage coefficient of the capacitor.

Output Transistor

The RT9064 includes a built-in low on-resistance P-MOSFET output transistor for low dropout voltage applications.

Error Amplifier

The Error Amplifier compares the output feedback voltage from an internal feedback voltage divider to an internal reference voltage and controls the P-MOSFET's gate voltage to maintain output voltage regulation.

Current Limit

The RT9064 provides a current limit function to prevent damage during output over-load or shorted-circuit conditions. The output current is detected by an internal sensing transistor.

Over-Temperature Protection

The over-temperature protection function will turn off the P-MOSFET when the internal junction temperature exceeds 150°C (typ.) and the output current exceeds 30mA. Once the junction temperature cools down by approximately 20°C, the regulator will automatically resume operation.

**Absolute Maximum Ratings** (Note 1)

- VCC to GND ----- -0.3V to 15V
- VOUT to VCC ----- -14V to 0.3V
- VOUT to GND ----- -0.3V to 6V
- Power Dissipation, P<sub>D</sub> @ T<sub>A</sub> = 25°C
  - SOT-23-3 ----- 0.41W
  - SOT-89-3 ----- 0.59W
- Package Thermal Resistance (Note 2)
  - SOT-23-3, θ<sub>JA</sub> ----- 243.3°C/W
  - SOT-89-3, θ<sub>JA</sub> ----- 167.7°C/W
- Lead Temperature (Soldering, 10 sec.) ----- 260°C
- Junction Temperature ----- 150°C
- Storage Temperature Range ----- -65°C to 150°C
- ESD Susceptibility (Note 3)
  - HBM (Human Body Model) ----- 2kV
  - MM (Machine Model) ----- 200V

**Recommended Operating Conditions** (Note 4)

- Supply Input Voltage, VCC ----- 3.5V to 14V
- Junction Temperature Range ----- -40°C to 125°C
- Ambient Temperature Range ----- -40°C to 85°C

**Electrical Characteristics**

(V<sub>OUT</sub> + 1V) < V<sub>CC</sub> < 14V, T<sub>A</sub> = 25°C, unless otherwise specified.)

Parameter	Symbol	Test Conditions	Min	Typ	Max	Unit
Output Voltage Range	V <sub>OUT</sub>		2.5	--	5	V
DC Output Accuracy		I <sub>LOAD</sub> = 1mA, V <sub>CC</sub> = V <sub>OUT</sub> + 0.5V	-2	--	2	%
Dropout Voltage	V <sub>Drop</sub>	I <sub>LOAD</sub> = 100mA, V <sub>OUT</sub> ≥ 4.5V	--	0.4	1.2	V
		I <sub>LOAD</sub> = 100mA, V <sub>OUT</sub> < 4.5V	--	--	1.5	
Quiescent Current	I <sub>Q</sub>	V <sub>CC</sub> = 5V, I <sub>LOAD</sub> = 0A	--	2	4	μA
Line Regulation	V <sub>LINE</sub>	I <sub>LOAD</sub> = 1mA, 3.5V ≤ V <sub>CC</sub> < 5.5V	--	0.1	0.2	%
		I <sub>LOAD</sub> = 1mA, 5.5V ≤ V <sub>CC</sub> ≤ 14V	--	0.1	0.3	
Load Regulation	V <sub>LOAD</sub>	I <sub>LOAD</sub> = 1mA to 200mA	--	0.5	1	%
Output Current Limit	I <sub>LIM</sub>	V <sub>OUT</sub> = 0.5 x V <sub>OUT(Normal)</sub> , V <sub>CC</sub> = 5V	240	320	400	mA
Power Supply Rejection Ratio	PSRR	f = 100Hz, I <sub>LOAD</sub> = 100mA	--	-60	--	dB
		f = 10kHz, I <sub>LOAD</sub> = 100mA	--	-40	--	
Output Noise Voltage	V <sub>ON</sub>	BW = 10Hz to 100kHz, C <sub>OUT</sub> = 1μF	--	27 x V <sub>OUT</sub>	--	μV <sub>RMS</sub>
Startup Time	t <sub>STR</sub>	V <sub>OUT</sub> = 3V, R <sub>L</sub> = 30Ω	--	500	--	μs
OTP Threshold			--	150	--	°C
OTP Hysteresis			--	20	--	°C

**Note 1.** Stresses beyond those listed “Absolute Maximum Ratings” may cause permanent damage to the device. These are stress ratings only, and functional operation of the device at these or any other conditions beyond those indicated in the operational sections of the specifications is not implied. Exposure to absolute maximum rating conditions may affect device reliability.

**Note 2.**  $\theta_{JA}$  is measured at  $T_A = 25^\circ\text{C}$  on a high effective thermal conductivity four-layer test board per JEDEC 51-7.

**Note 3.** Devices are ESD sensitive. Handling precaution is recommended.

**Note 4.** The device is not guaranteed to function outside its operating conditions.

## Typical Application Circuit

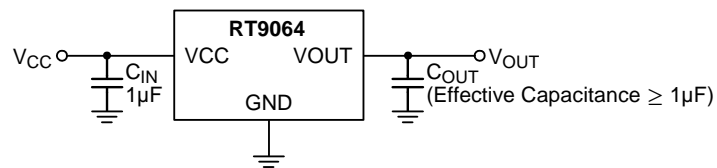

**Typical Operating Characteristics**

**Output Voltage vs. Temperature**

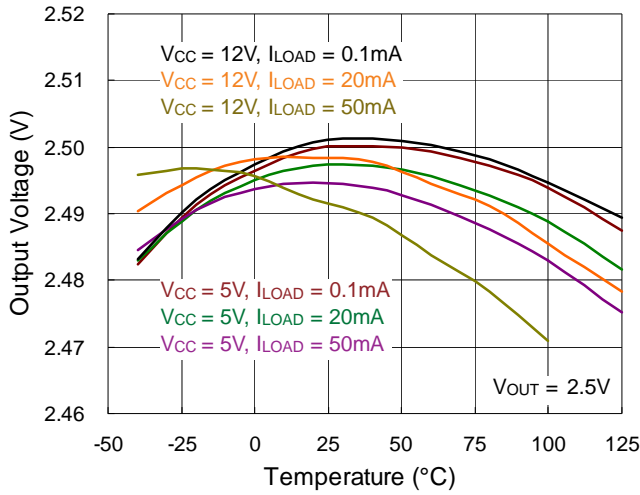

**Output Voltage vs. Output Current**

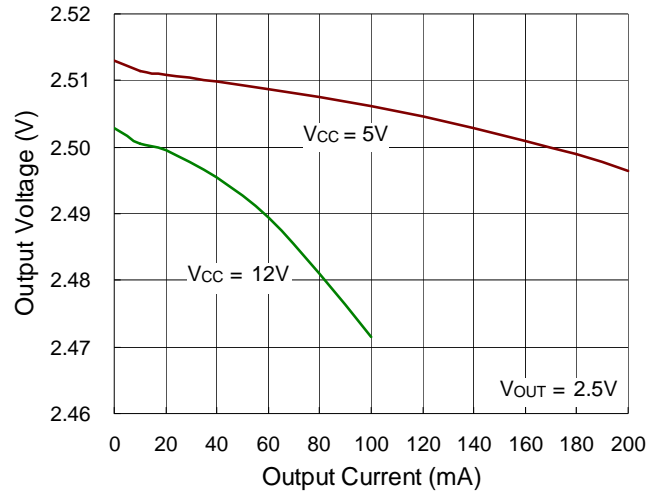

**Output Voltage vs. Input Voltage**

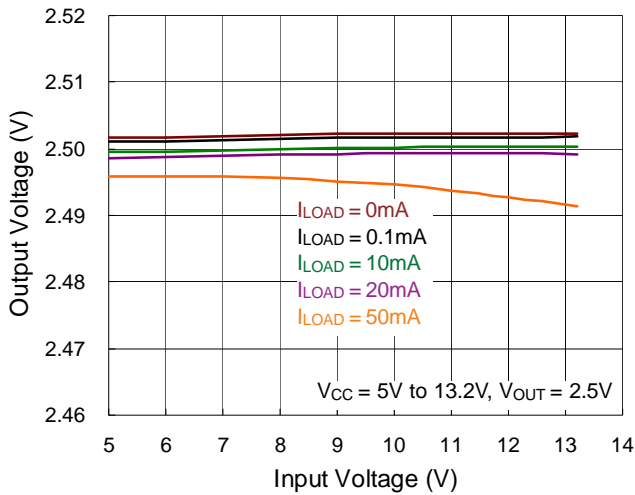

**Quiescent Current vs. Temperature**

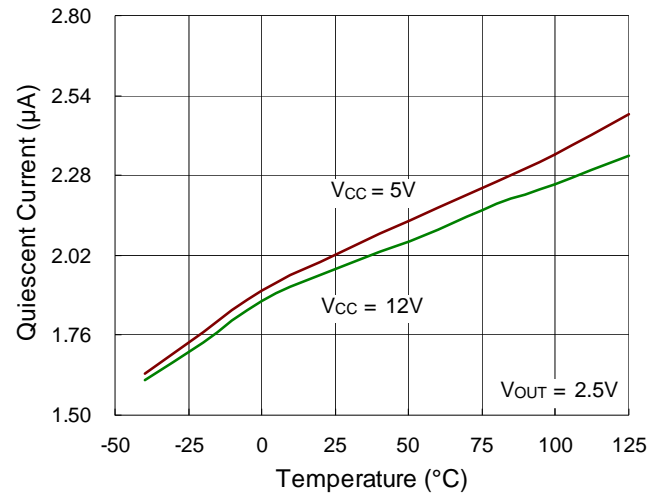

**Quiescent Current vs. Input Voltage**

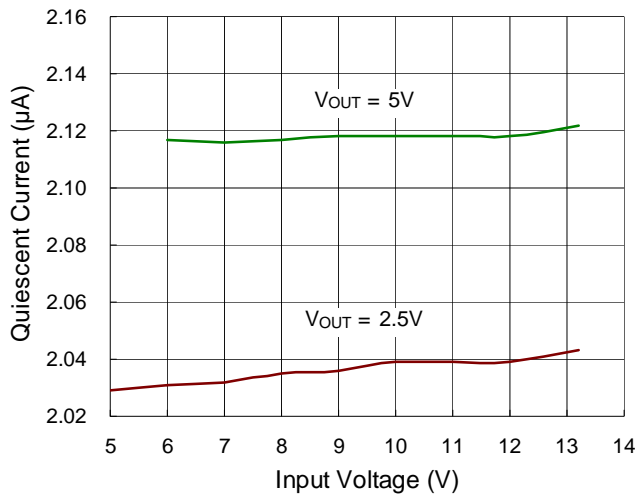

**Dropout Voltage vs. Temperature**

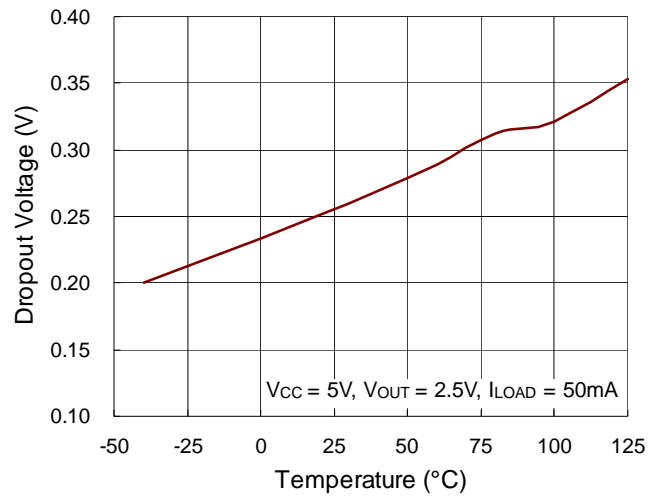

**Current Limit vs. Temperature**

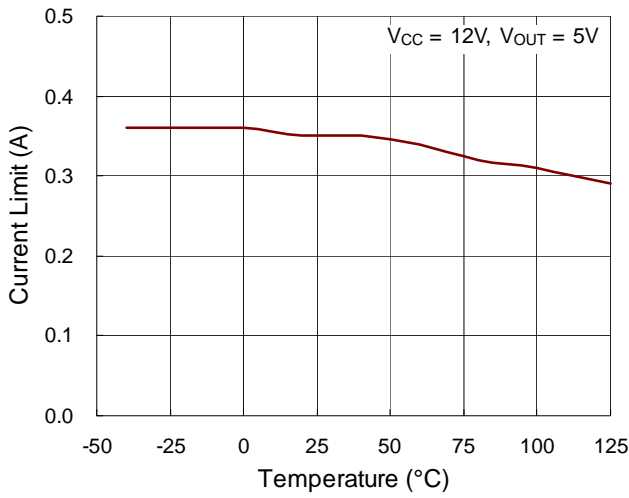

**PSRR vs. Frequency**

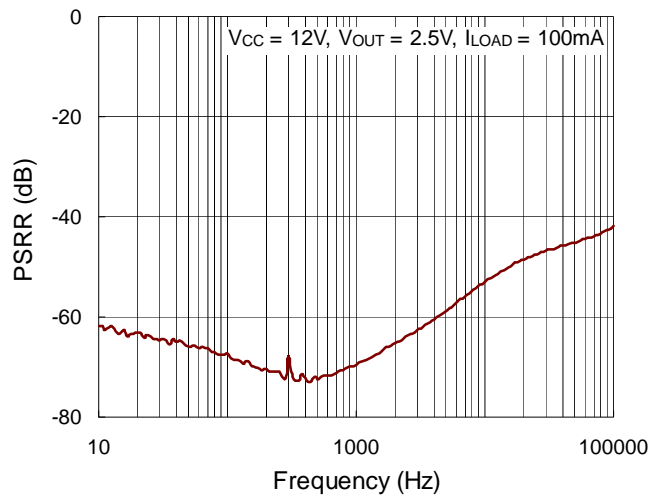

**Load Transient Response**

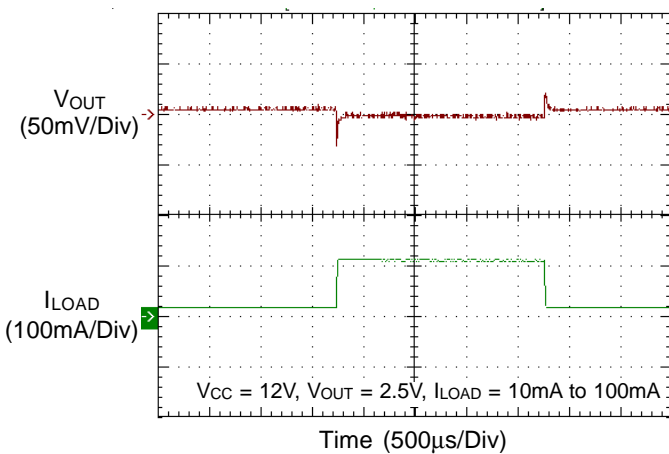

**Line Transient Response**

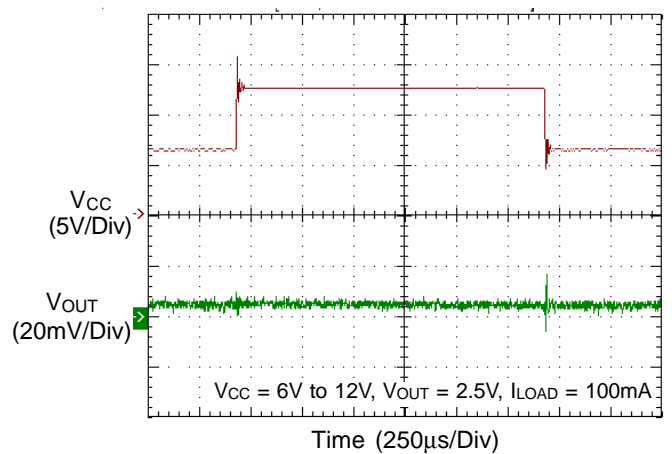

**Ground Current vs. Load Current**

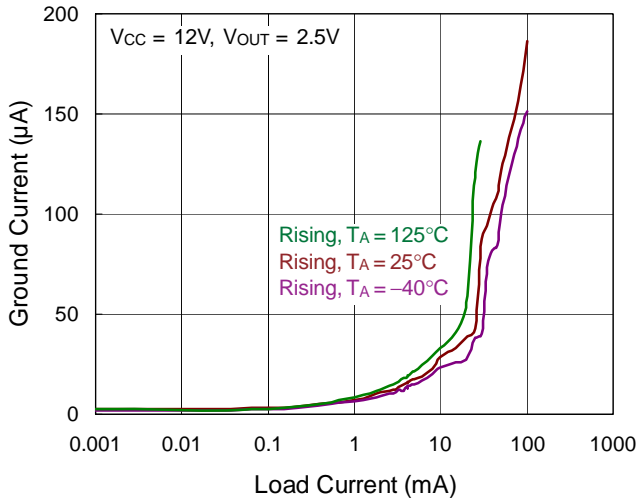

**Power Up Response**

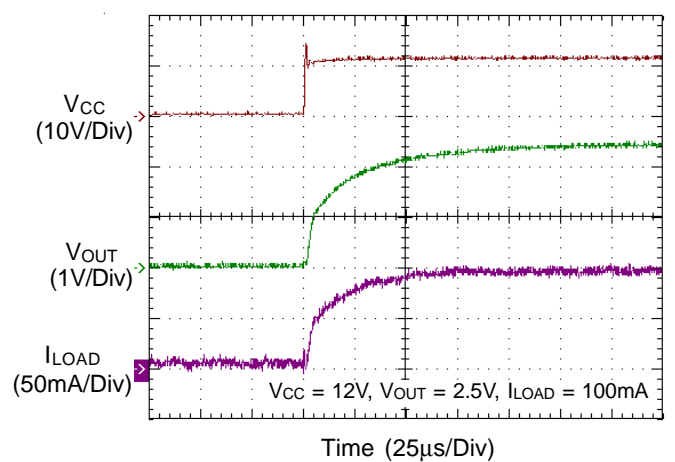

## Applications Information

Like any low dropout linear regulator, the RT9064's external input and output capacitors must be properly selected for stability and performance. Use a 1μF or larger input capacitor and place it close to the IC's VCC and GND pins.

Any output capacitor meeting the minimum 1mΩ ESR (Equivalent Series Resistance) and effective capacitance larger than 1μF requirement may be used. Place the output capacitor close to the IC's VOUT and GND pins. Increasing capacitance and decreasing ESR can improve the circuit's PSRR and line transient response.

### Thermal Considerations

For continuous operation, do not exceed absolute the maximum junction temperature. The maximum power dissipation depends on the thermal resistance of the IC package, PCB layout, rate of surrounding airflow, and the allowed difference between the junction and ambient temperatures. The maximum power dissipation can be calculated by the following formula :

$$P_{D(MAX)} = (T_{J(MAX)} - T_A) / \theta_{JA}$$

where  $T_{J(MAX)}$  is the maximum junction temperature,  $T_A$  is the ambient temperature, and  $\theta_{JA}$  is the junction to ambient thermal resistance.

The recommended operating conditions specify a maximum junction temperature is 125°C. The junction to ambient thermal resistance,  $\theta_{JA}$ , is layout dependent. On a standard JEDEC 51-7 four-layer thermal test board, the thermal resistance,  $\theta_{JA}$ , of the SOT-23-3 package is 243.3°C/W. For the SOT-89-3 package, the  $\theta_{JA}$ , is 167.7°C/W. The maximum power dissipation at  $T_A = 25^\circ\text{C}$  can be calculated by the following formula :

$$P_{D(MAX)} = (125^\circ\text{C} - 25^\circ\text{C}) / (243.3^\circ\text{C}/\text{W}) = 0.41\text{W for SOT-23-3 package}$$

$$P_{D(MAX)} = (125^\circ\text{C} - 25^\circ\text{C}) / (167.7^\circ\text{C}/\text{W}) = 0.59\text{W for SOT-89-3 package}$$

For a fixed  $T_{J(MAX)}$  of 125°C, the maximum power dissipation depends on the operating ambient temperature and the package's thermal resistance,  $\theta_{JA}$ . The derating curve in Figure 1 shows the effect of rising ambient temperature on the maximum recommended power dissipation.

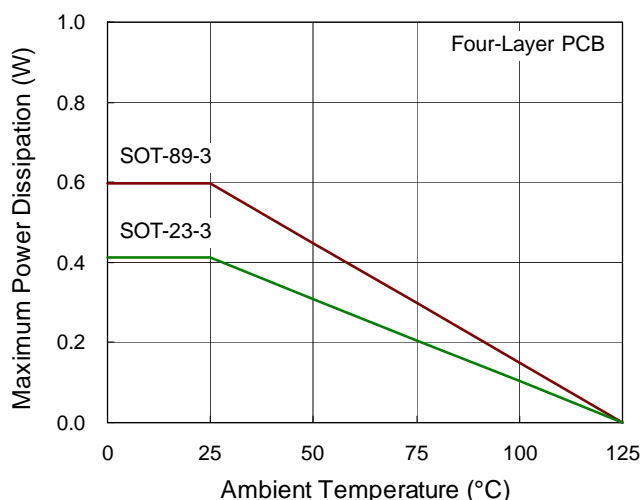
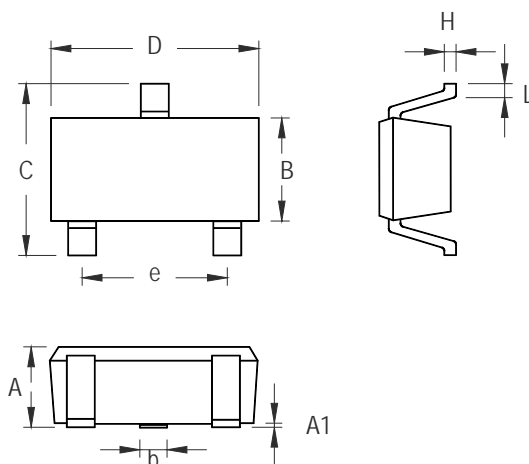

Figure 1. Derating Curve of Maximum Power Dissipation

## Outline Dimension



Symbol	Dimensions In Millimeters		Dimensions In Inches	
	Min	Max	Min	Max
A	0.889	1.295	0.035	0.051
A1	0.000	0.152	0.000	0.006
B	1.397	1.803	0.055	0.071
b	0.356	0.508	0.014	0.020
C	2.591	2.997	0.102	0.118
D	2.692	3.099	0.106	0.122
e	1.803	2.007	0.071	0.079
H	0.080	0.254	0.003	0.010
L	0.300	0.610	0.012	0.024

**SOT-23-3 Surface Mount Package**



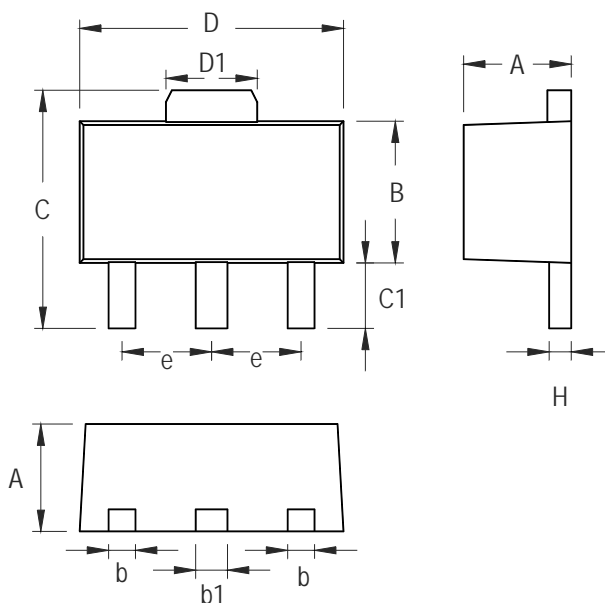

Symbol	Dimensions In Millimeters		Dimensions In Inches	
	Min	Max	Min	Max
A	1.397	1.600	0.055	0.063
b	0.356	0.483	0.014	0.019
B	2.388	2.591	0.094	0.102
b1	0.406	0.533	0.016	0.021
C	3.937	4.242	0.155	0.167
C1	0.787	1.194	0.031	0.047
D	4.394	4.597	0.173	0.181
D1	1.397	1.753	0.055	0.069
e	1.448	1.549	0.057	0.061
H	0.356	0.432	0.014	0.017

**3-Lead SOT-89 Surface Mount Package**

**Richtek Technology Corporation**

14F, No. 8, Tai Yuen 1<sup>st</sup> Street, Chupei City

Hsinchu, Taiwan, R.O.C.

Tel: (8863)5526789

Richtek products are sold by description only. Richtek reserves the right to change the circuitry and/or specifications without notice at any time. Customers should obtain the latest relevant information and data sheets before placing orders and should verify that such information is current and complete. Richtek cannot assume responsibility for use of any circuitry other than circuitry entirely embodied in a Richtek product. Information furnished by Richtek is believed to be accurate and reliable. However, no responsibility is assumed by Richtek or its subsidiaries for its use; nor for any infringements of patents or other rights of third parties which may result from its use. No license is granted by implication or otherwise under any patent or patent rights of Richtek or its subsidiaries.