

# Electrostatic Sensor

## EF-S1 SERIES

Related Information

- General terms and conditions..... F-7
- Selection guide ..... P.1157~
- General precautions..... P.1501



### Achieve easier in-line measurement

#### Constantly check static in lines!

With this inline-capable surface potential sensor, you can constantly monitor static that will be generated in various places in a process while running a line and, if there is any abnormality, you can respond to it immediately. It will clarify damage or failure caused by static which has been hard to find out before, allowing the maintenance of stable quality.

#### Reduce the inspection man-hours for the ionizer

You can see the neutralizing effect of the ionizer in real time, so it is possible to objectively verify damage on the ionizer or time to replace expendable parts. By quickly finding decrease in the effect of the ionizer, it will relieve concerns like "Is it really neutralizing?", and reduce the man-hours required for inspection and verification.

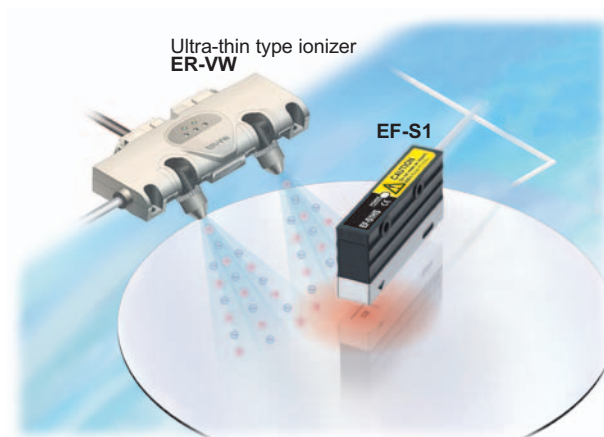

#### New proposal for electrostatic measurement

Unlike the off-line measurement with a handheld instrument, it can be installed in a line in the same way as photoelectric sensors, thus reduces variation in measurements caused by differences in workers, measurement sites and distance to help improve reliability. In addition, with its variety of features such as the window comparator output that outputs a signal when the measured value exceeds the measurement range, and analog output essential for data collection and analysis, it enables line control for anti-static measures similar to the beam sensor (photoelectric sensor).

- FIBER SENSORS
- LASER SENSORS
- PHOTOELECTRIC SENSORS
- MICRO PHOTOELECTRIC SENSORS
- AREA SENSORS
- LIGHT CURTAINS / SAFETY COMPONENTS
- PRESSURE / FLOW SENSORS
- INDUCTIVE PROXIMITY SENSORS
- PARTICULAR USE SENSORS
- SENSOR OPTIONS
- SIMPLE WIRE-SAVING UNITS
- WIRE-SAVING SYSTEMS
- MEASUREMENT SENSORS
- STATIC ELECTRICITY PREVENTION DEVICES
- LASER MARKERS
- PLC
- HUMAN MACHINE INTERFACES
- ENERGY CONSUMPTION VISUALIZATION COMPONENTS
- FA COMPONENTS
- MACHINE VISION SYSTEMS
- UV CURING SYSTEMS

- Selection Guide
- Static Removers
- Cleaning Box
- Pulse Air-gun
- Electrostatic Sensor

**APPLICATIONS**

Surface potential measurement when releasing BG sheets

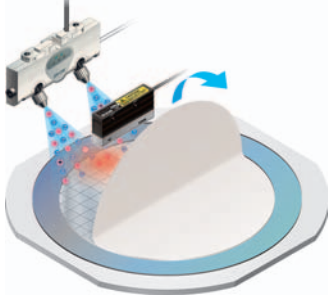

Surface potential measurement during chip release electrification

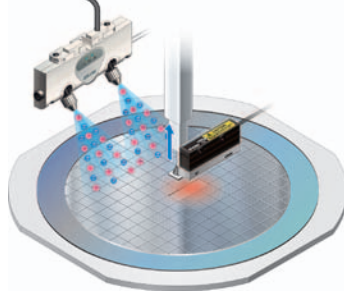

Surface potential measurement during loading and unloading

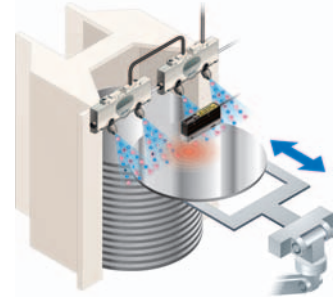

Measurement of lead frame charge removal

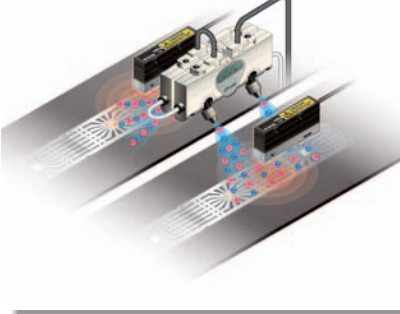

Measurement of frictional electrification of printed circuit boards

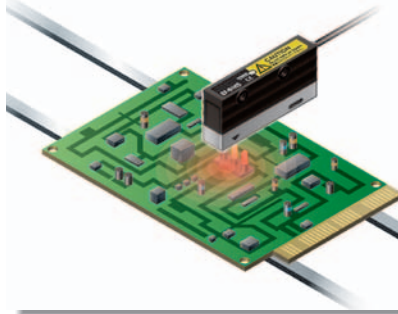

Measurement of frictional electrification of LCD modules

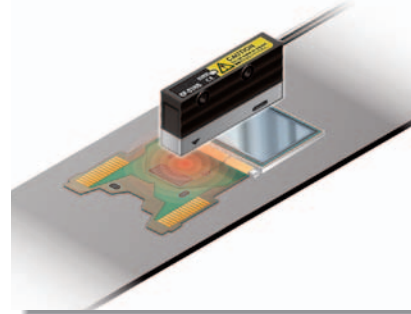

**BASIC PERFORMANCE**

**Suitable for measuring under severe conditions**

High-precision design with a repeatability precision of  $\pm 0.3\%$  F.S. Even very slight differences in potential will not be skipped over.

**MOUNTING / SIZE**

**Lightweight and compact for easy setup in any location**

The sensor head only weighs 90 g approx. Installation can be carried out easily using just a bracket so that it is suitable for use in a wide variety of applications. In addition, power consumption is low so the devices can be utilized without concerns of high running costs.

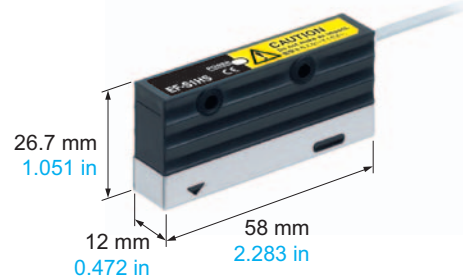

**FUNCTIONS**

**Easy-to-read 2-color dual display**

The controller is equipped with a red and a green display. Current values and threshold values can be viewed at a glance.

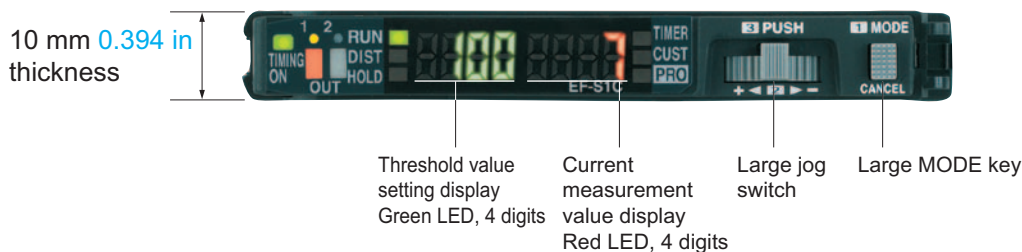

FIBER SENSORS

LASER SENSORS

PHOTOELECTRIC SENSORS

MICRO PHOTOELECTRIC SENSORS

AREA SENSORS

LIGHT CURTAINS / SAFETY COMPONENTS

PRESSURE / FLOW SENSORS

INDUCTIVE PROXIMITY SENSORS

PARTICULAR USE SENSORS

SENSOR OPTIONS

SIMPLE WIRE-SAVING UNITS

WIRE-SAVING SYSTEMS

MEASUREMENT SENSORS

STATIC ELECTRICITY PREVENTION DEVICES

LASER MARKERS

PLC

HUMAN MACHINE INTERFACES

ENERGY CONSUMPTION VISUALIZATION COMPONENTS

FA COMPONENTS

MACHINE VISION SYSTEMS

UV CURING SYSTEMS

Selection Guide

Static Removers

Cleaning Box

Pulse Air-gun

Electrostatic Sensor

**EF-S1**

- FIBER SENSORS
- LASER SENSORS
- PHOTOELECTRIC SENSORS
- MICRO PHOTOELECTRIC SENSORS
- AREA SENSORS
- LIGHT CURTAINS / SAFETY COMPONENTS
- PRESSURE / FLOW SENSORS
- INDUCTIVE PROXIMITY SENSORS
- PARTICULAR USE SENSORS
- SENSOR OPTIONS
- SIMPLE WIRE-SAVING UNITS
- WIRE-SAVING SYSTEMS
- MEASUREMENT SENSORS
- STATIC ELECTRICITY PREVENTION DEVICES
- LASER MARKERS
- PLC
- HUMAN MACHINE INTERFACES
- ENERGY CONSUMPTION VISUALIZATION COMPONENTS
- FA COMPONENTS
- MACHINE VISION SYSTEMS
- UV CURING SYSTEMS
- Selection Guide
- Static Removers
- Cleaning Box
- Pulse Air-gun
- Electrostatic Sensor

### FUNCTIONS

#### A variety of functions for a wide range of applications

A large number of functions for a variety of applications are available, including 0-adjust, hysteresis setting, window comparator output, and +potential / -potential peak hold (external timing input) measurement.

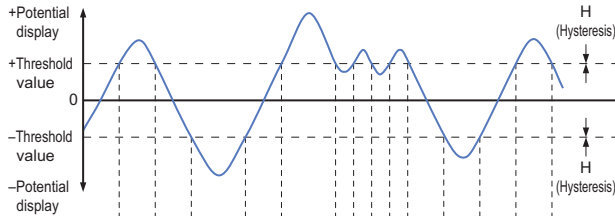

#### • Window comparator mode



#### • 2 output mode

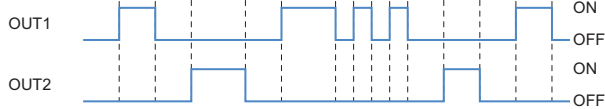

#### Easy data management with analog output

Data logger can collect and analyze data, which will be helpful when reviewing the installation angle of the ionizer and the number of ionizers.

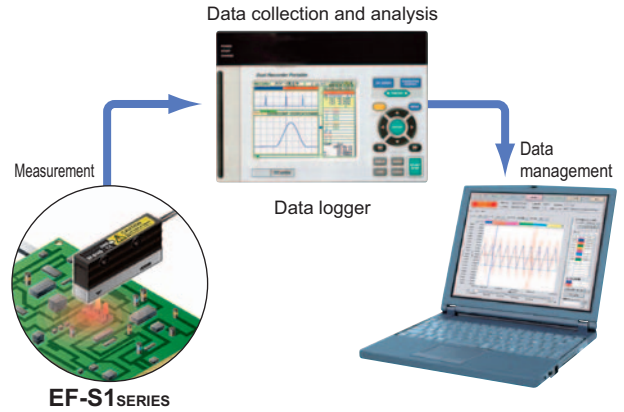

### ORDER GUIDE

#### Sensor head

Appearance	Model No.	Measurement range (Note)
	<b>EF-S1HS</b>	8.0 to 20.5 mm <b>0.315 to 0.807 in</b> ( $\pm 1$ kV range mode) 21.0 to 100 mm <b>0.827 to 3.937 in</b> ( $\pm 2$ kV range mode)

Note: Set the distance between the sensor head and the sensing object by using the controller before use.

#### Controller

Appearance	Model No.	Output type
	<b>EF-S1C</b>	NPN open-collector transistor Analog output • Output voltage: 1 to 5 V

#### Accessory

- **CN-EP1** (Connector for controller) **5 pcs. per set** (Note)



Note: One is attached to each sensor head according to standard.

### OPTIONS

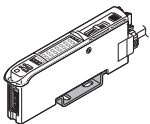
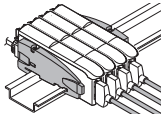
Designation	Appearance	Model No.	Description
Controller mounting bracket		<b>MS-DIN-2</b>	Mounting bracket for controller
End plates		<b>MS-DIN-E</b>	If the controller moves because of the way it has been installed to the DIN rail, use clamps at both sides to secure the controller so that it will not move. <b>2 pcs. per set</b>

**SPECIFICATIONS****Sensor head**

Item	Model No.	EF-S1HS
Applicable controller		<b>EF-S1C</b>
Measurement range (Measurement range) (Note 2, 3, 4)		8.0 to 20.5 mm <b>0.315 to 0.807 in</b> ( $\pm 1$ kV range mode) 21.0 to 100 mm <b>0.827 to 3.937 in</b> ( $\pm 2$ kV range mode)
Power indicator		Green LED
Ambient temperature		0 to +40 °C <b>+0 to +104 °F</b> (No dew condensation), Storage: -20 to +60 °C <b>-4 to +140 °F</b>
Ambient humidity		35 to 65 % RH, Storage: 35 to 85 % RH
Vibration resistance		10 to 150 Hz frequency, 0.75 mm <b>0.030 in</b> amplitude in X, Y and Z directions for two hours each
Shock resistance		98 m/s <sup>2</sup> acceleration (10 G approx.) in X, Y and Z directions for five times each
Material		Enclosure: Heat resistant ABS, Measuring part cover: Stainless steel (SUS304)
Cable		0.09 mm <sup>2</sup> , 3-core shielded cable, 5 m <b>16.404 ft</b> long (with controller connector) (Note 5)
Weight		Net weight: 90 g approx., Gross weight: 130 g approx.

- Notes: 1) Where measurement conditions have not been specified precisely, the conditions used were an ambient temperature of +20 °C **+68 °F**.  
2) Set the distance between the sensor head and the sensing object by using the controller before use.  
3) The measurement range mode is switched automatically when the measurement range setting is changed at the controller.  
4) Measurement areas will vary depending on the measurement distances.  
5) Cable cannot be extended.

**Controller**

Item	Model No.	EF-S1C
Applicable sensor head		<b>EF-S1HS</b>
Supply voltage		24V DC $\pm 10$ %
Current consumption		Normal operation: 50 mA or less, ECO mode: 40 mA or less
Display range (Measurement range) (Note 2)		-1,000 to 1,000 ( $\pm 1$ kV range mode) -1,999 to 1,999 ( $\pm 2$ kV range mode)
Repeatability		$\pm 0.3$ % F.S. (Note 3)
Linearity		$\pm 0.5$ % F.S. (Note 3, 4, 6)
Temperature characteristics		0.05 % F.S./°C (Note 3, 5)
Judgment outputs (OUT 1, OUT 2)		NPN open-collector transistor <ul style="list-style-type: none"> <li>• Maximum sink current: 100 mA</li> <li>• Applied voltage: 30 V DC or less (between judgment output and 0 V)</li> <li>• Residual voltage: 1.5 V or less (at 100 mA sink current)</li> </ul>
Response time		10 ms, 20 ms (STD), 100 ms, 200 ms, 400 ms, 800 ms switching method
Output operation		OUT1: +potential measurement output or window comparator output OUT2: -potential measurement output or error output
Short-circuit protection		Incorporated
Analog output (Note 6)		Analog voltage <ul style="list-style-type: none"> <li>• Output voltage: 1 to 5 V</li> <li>• Output impedance: 100 <math>\Omega</math> approx.</li> </ul>
Response time		20 ms, 30 ms (STD), 110 ms, 210 ms, 410 ms, 810 ms switching method
Timing input / 0-adjust input		NPN non-contact input <ul style="list-style-type: none"> <li>• Signal condition High: +V or open, Low: 0 to +2 V (source current 0.5 mA or less)</li> <li>• Input impedance: 10 k<math>\Omega</math> approx.</li> </ul>
Ambient temperature		-10 to +55 °C <b>+14 to +131 °F</b> (No dew condensation or icing allowed), Storage: -20 to +70 °C <b>-4 to +158 °F</b>
Ambient humidity		35 to 85 % RH, Storage: 35 to 85 % RH
Material		Enclosure: Heat-resistant ABS, Case cover: Polycarbonate, Mode key: Acrylic, Jog switch: Heat-resistant ABS
Cable		0.2 mm <sup>2</sup> 6-core cable, 2 m <b>6.562 ft</b> long
Cable extension		Extension up to total 10 m <b>32.808 ft</b> is possible with 0.3 mm <sup>2</sup> , or more, cable.
Weight		Net weight: 65 g approx., Gross weight: 110 g approx.

- Notes: 1) Where measurement conditions have not been specified precisely, the conditions used were an ambient temperature of +20 °C **+68 °F**.  
2) The display range (measurement range) is switched automatically when the measurement distance setting is changed at the controller.  
3) F.S. is 2,000 V (-1,000 V to 1,000 V) for the  $\pm 1$  kV range mode and 4,000 V (-2,000 V to 2,000 V) for the  $\pm 2$  kV range mode.  
4) The values given are for when the measured potential is  $\pm 200$  V or less in the  $\pm 1$  kV range mode and  $\pm 400$  V or less in the  $\pm 2$  kV range mode. If the measured potentials are outside these values, the values will be equal to the displayed values  $\pm 5$  %.  
5) The values given are for when the measured potential is  $\pm 200$  V or less in the  $\pm 1$  kV range mode and  $\pm 400$  V or less in the  $\pm 2$  kV range mode. If the measured potentials are outside these values, the values will be 0.5 %/°C of the displayed values.  
6) In order to satisfy the linearity specifications for the analog output, do not use the judgment output.

FIBER  
SENSORSLASER  
SENSORSPHOTO-  
ELECTRIC  
SENSORSMICRO  
PHOTO-  
ELECTRIC  
SENSORSAREA  
SENSORSLIGHT  
CURTAINS /  
SAFETY  
COMPONENTSPRESSURE /  
FLOW  
SENSORSINDUCTIVE  
PROXIMITY  
SENSORSPARTICULAR  
USE  
SENSORSSENSOR  
OPTIONSSIMPLE  
WIRE-SAVING  
UNITSWIRE-SAVING  
SYSTEMSMEASURE-  
MENT  
SENSORSSTATIC  
ELECTRICITY  
PREVENTION  
DEVICESLASER  
MARKERS

PLC

HUMAN  
MACHINE  
INTERFACESENERGY  
CONSUMPTION  
VISUALIZATION  
COMPONENTSFA  
COMPONENTSMACHINE  
VISION  
SYSTEMSUV  
CURING  
SYSTEMSSelection  
GuideStatic  
RemoversCleaning  
BoxPulse  
Air-gunElectrostatic  
Sensor**EF-S1**

**I/O CIRCUIT AND WIRING DIAGRAMS**

**EF-S1C**

NPN output

**I/O circuit diagram**

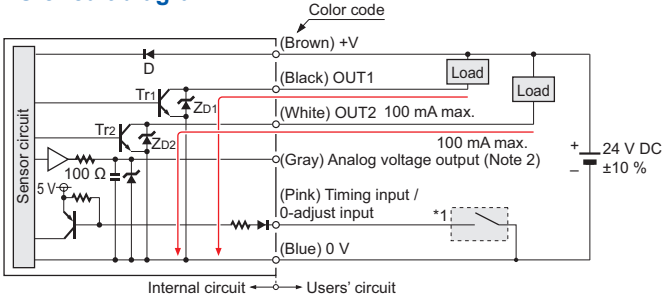

**Wiring diagram**

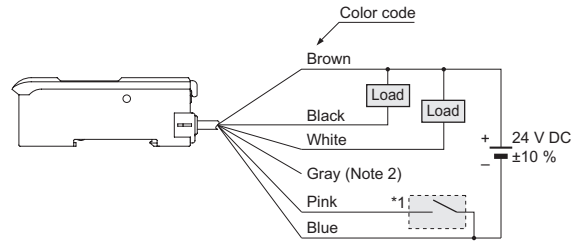

- Notes: 1) If using together with an ionizer, the 0 V line of this product should be connected to the ionizer ground. In addition, the metal parts of the sensor head (**EF-S1HS**) are connected to the 0 V line, so it should be insulated during installation.  
 2) In case of using the analog voltage output, connect a device having a input impedance of 1MΩ or more. Further, the analog voltage output does not incorporate a short-circuit protection circuit. Do not connect it directly to a power supply or a capacitive load.

**<Points to note when using analog output>**  
 Because the 0 V lines for judgment output and analog voltage output are common, the analog voltage output may vary depending on the load current. In order to satisfy the linearity specifications for the analog voltage output, do not use the judgment output.

**\*Connector for controller (CN-EP1) pin position**

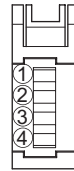

Terminal No.	Mating cable
①	+V: Brown
②	0 V: Blue
③	Sensor output: Orange / Violet
④	Shield wire

\*1  
 Non-voltage contact or NPN open-collector transistor

• Timing input / 0-adjust input  
 High (+V or open): Ineffective  
 Low (0 to +2 V): Effective

Symbols ... D: Reverse supply polarity protection diode  
 ZD1, ZD2: Surge absorption zener diode  
 Tr1, Tr2 : NPN output transistor

**SENSING CHARACTERISTICS (TYPICAL)**

**EF-S1HS**

**Measurement range – field of measurement**

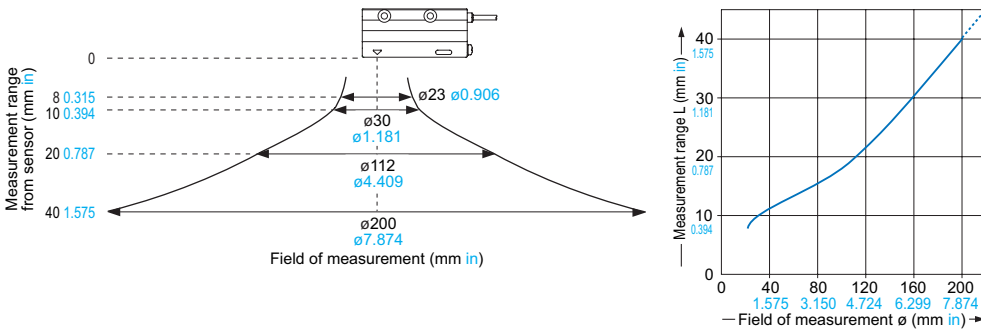

- This product is not an instrument for measuring the absolute amount of potential.
- This product measures the electric field. Thus, the presence of objects other than the object to be measured that disturb the electric field in the measurement area (see left) or around the sensor head will affect measurement accuracy.

(The closer the measurement distance, the less affected by surrounding objects.)

For accurate measurement, install the sensor head considering measurement distance, measurement area and the surrounding environment.

**Installation tolerance -**

**Display value tolerance characteristics**

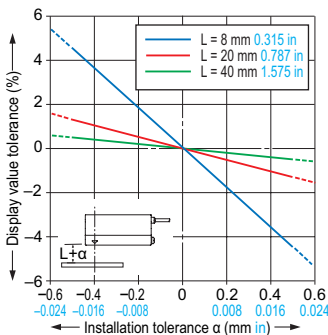

**Angular deviation ①**

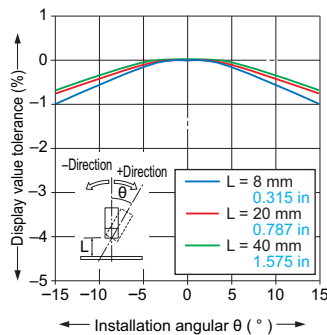

**Angular deviation ②**

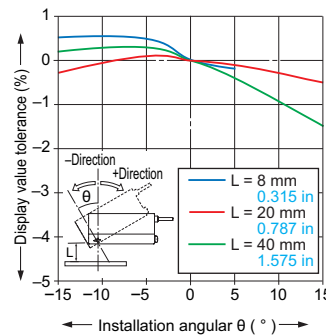

Note: If the installation tolerance is greater than 0.5 mm 0.020 in, change the measurement range setting at the controller.

Note: If the value is tilting toward the positive side, the enclosure is causing interference, so if L = 8 mm 0.315 in, there will be no graph display at 5 degrees or higher.



**PRECAUTIONS FOR PROPER USE**

Refer to p.1501 for general precautions.

FIBER  
SENSORSLASER  
SENSORSPHOTO-  
ELECTRIC  
SENSORSMICRO  
PHOTO-  
ELECTRIC  
SENSORSAREA  
SENSORSLIGHT  
CURTAINS /  
SAFETY  
COMPONENTSPRESSURE /  
FLOW  
SENSORSINDUCTIVE  
PROXIMITY  
SENSORSPARTICULAR  
USE  
SENSORSSENSOR  
OPTIONSSIMPLE  
WIRE-SAVING  
UNITSWIRE-SAVING  
SYSTEMSMEASURE-  
MENT  
SENSORSSTATIC  
ELECTRICITY  
PREVENTION  
DEVICESLASER  
MARKERS

PLC

HUMAN  
MACHINE  
INTERFACESENERGY  
CONSUMPTION  
VISUALIZATION  
COMPONENTSFA  
COMPONENTSMACHINE  
VISION  
SYSTEMSUV  
CURING  
SYSTEMSSelection  
Guide  
Static  
Removers  
Cleaning  
Box  
Pulse  
Air-gun  
Electrostatic  
Sensor**EF-S1**

- Never use this product as a sensing device for personnel protection.
- In case of using sensing devices for personnel protection, use products which meet laws and standards, such as OSHA, ANSI or IEC etc., for personnel protection applicable in each region or country.

- The sensor head is manufactured according to specifications that are complete for use in combination with the optional exclusive controller. Be sure to use it together with the exclusive controller.
- Do not touch the sensor head and surrounding parts. If this is not observed, it may cause measurement accuracy to drop.
- The metal parts of the sensor head are connected to the 0V line of the exclusive controller power supply, so it should be insulated during use.
- Do not use with a plus ground.

**Mounting****Sensor head**

- Do not let dust stick to the measurement unit. When dust has adhered to the measurement unit and its surroundings, it may interfere with proper measurement. If dust has adhered to the measuring unit, blow it off using an air blower, etc.
- When fittings are charged, it affects the measurement accuracy, so use after grounding the fittings. However, the metal part of the case must be insulated.
- This product has higher sensitivity when used in the measurement distance of 21 to 100 mm **0.827 to 3.937 in** compared to when used in the measurement distance of 8 to 20.5 mm **0.315 to 0.807 in**, thus it becomes more susceptible to disturbance noise. Check the usage environment before using this product.

**Wiring**

- Make sure that the power supply is off while wiring.
- If power is supplied from a commercial switching regulator, ensure that the frame ground (F.G.) terminal of the power supply is connected to an actual ground.
- In case noise generating equipment (switching regulator, inverter motor, etc.) is used in the vicinity of this product, connect the frame ground (F.G.) terminal of the equipment to an actual ground.
- Do not run the wires together with high-voltage lines or power lines or put them in the same raceway. This can cause malfunction due to induction.
- A thin cable of 0.09 mm<sup>2</sup> is employed for the sensor head. Note that pulling the cable with force may break the cable.
- Cannot extend the cable of the sensor head.
- Make sure that stress is not applied directly to the sensor head cable joint.
- Extension up to total 10m **32.81 ft** is possible with 0.3mm<sup>2</sup>, or more, cable. However, in order to reduce noise, make the wiring as short as possible.

**Others**

- Do not use during the initial transient time (3 sec.) after the power supply is switched on.
- In order for stable sensing to be carried out, wait for 10 min. after turning on the power before use.
- Do not use in places where there are strong electric fields apart from those for the object being measured.
- Do not use in strong magnetic fields.

**DIMENSIONS (Unit: mm in)**

The CAD data in the dimensions can be downloaded from our website.

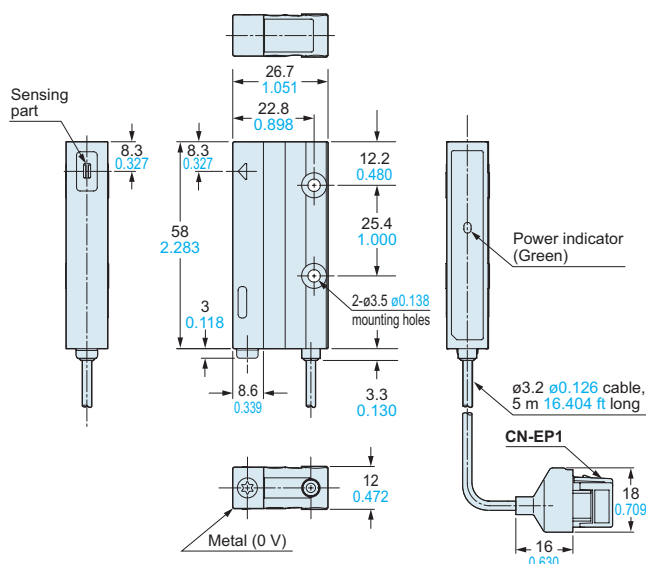
**EF-S1HS****Sensor head****EF-S1C****Controller**