

BK PRECISION®

Model: 9115, 9115-AT, 9116, 9117

Multi-Range DC Power Supply

USER MANUAL



Safety Summary

The following safety precautions apply to both operating and maintenance personnel and must be followed during all phases of operation, service, and repair of this instrument.

WARNING

Before applying power to this instrument:

- Read and understand the safety and operational information in this manual.
- Apply all the listed safety precautions.
- Verify that the voltage selector at the line power cord input is set to the correct line voltage. Operating the instrument at an incorrect line voltage will void the warranty.
- Make all connections to the instrument before applying power.
- Do not operate the instrument in ways not specified by this manual or by B&K Precision.

Failure to comply with these precautions or with warnings elsewhere in this manual violates the safety standards of design, manufacture, and intended use of the instrument. B&K Precision assumes no liability for a customer's failure to comply with these requirements.

Category rating

The IEC 61010 standard defines safety category ratings that specify the amount of electrical energy available and the voltage impulses that may occur on electrical conductors associated with these category ratings. The category rating is a Roman numeral of I, II, III, or IV. This rating is also accompanied by a maximum voltage of the circuit to be tested, which defines the voltage impulses expected and required insulation clearances. These categories are:

Category I (CAT I): Measurement instruments whose measurement inputs are not intended to be connected to the mains supply. The voltages in the environment are typically derived from a limited-energy transformer or a battery.

Category II (CAT II): Measurement instruments whose measurement inputs are meant to be connected to the mains supply at a standard wall outlet or similar sources. Example measurement environments are portable tools and household appliances.

Category III (CAT III): Measurement instruments whose measurement inputs are meant to be connected to the mains installation of a building. Examples are measurements inside a building's circuit breaker panel or the wiring of permanently-installed motors.

Category IV (CAT IV): Measurement instruments whose measurement inputs are meant to be connected to the primary power entering a building or other outdoor wiring.

WARNING

Do not use this instrument in an electrical environment with a higher category rating than what is specified in this manual for this instrument.

WARNING

You must ensure that each accessory you use with this instrument has a category rating equal to or higher than the instrument's category rating to maintain the instrument's category rating. Failure to do so will lower the category rating of the measuring system.

Electrical Power

This instrument is intended to be powered from a CATEGORY II mains power environment. The mains power should be 120 V RMS or 240 V RMS. Use only the power cord supplied with the instrument and ensure it is appropriate for your country of use.

Ground the Instrument

WARNING

To minimize shock hazard, the instrument chassis and cabinet must be connected to an electrical safety ground. This instrument is grounded through the ground conductor of the supplied, three-conductor AC line power cable. The power cable must be plugged into an approved three-conductor electrical outlet. The power jack and mating plug of the power cable meet IEC safety standards.

WARNING

Do not alter or defeat the ground connection. Without the safety ground connection, all accessible conductive parts (including control knobs) may provide an electric shock. Failure to use a properly-grounded approved outlet and the recommended three-conductor AC line power cable may result in injury or death.

WARNING

Unless otherwise stated, a ground connection on the instrument's front or rear panel is for a reference of potential only and is not to be used as a safety ground.

Do not operate in an explosive or flammable atmosphere

⚠ WARNING

Do not operate the instrument in the presence of flammable gases or vapors, fumes, or finely-divided particulates.

⚠ WARNING

The instrument is designed to be used in office-type indoor environments. Do not operate the instrument

- In the presence of noxious, corrosive, or flammable fumes, gases, vapors, chemicals, or finely-divided particulates.
- In relative humidity conditions outside the instrument's specifications.
- In environments where there is a danger of any liquid being spilled on the instrument or where any liquid can condense on the instrument.
- In air temperatures exceeding the specified operating temperatures.
- In atmospheric pressures outside the specified altitude limits or where the surrounding gas is not air.
- In environments with restricted cooling air flow, even if the air temperatures are within specifications.
- In direct sunlight.

⚠ CAUTION

This instrument is intended to be used in an indoor pollution degree 2 environment. The operating temperature range is 0 °C to 40 °C and the operating humidity range is up to 95% relative humidity with no condensation allowed.

Measurements made by this instrument may be outside specifications if the instrument is used in non-office-type environments. Such environments may include rapid temperature or humidity changes, sunlight, vibration and/or mechanical shocks, acoustic noise, electrical noise, strong electric fields, or strong magnetic fields.

Do not operate instrument if damaged

⚠ WARNING

If the instrument is damaged, appears to be damaged, or if any liquid, chemical, or other material gets on or inside the instrument, remove the instrument's power cord, remove the instrument from service, label it as not to be operated, and return the instrument to B&K

Precision for repair. Notify B&K Precision of the nature of any contamination of the instrument.

Clean the instrument only as instructed

⚠ WARNING

Do not clean the instrument, its switches, or its terminals with contact cleaners, abrasives, lubricants, solvents, acids/bases, or other such chemicals. Clean the instrument only with a clean dry lint-free cloth or as instructed in this manual.

Not for critical applications

⚠ WARNING

This instrument is not authorized for use in contact with the human body or for use as a component in a life-support device or system.

Do not touch live circuits

⚠ WARNING

Instrument covers must not be removed by operating personnel. Component replacement and internal adjustments must be made by qualified service-trained maintenance personnel who are aware of the hazards involved when the instrument's covers and shields are removed. Under certain conditions, even with the power cord removed, dangerous voltages may exist when the covers are removed. To avoid injuries, always disconnect the power cord from the instrument, disconnect all other connections (for example, test leads, computer interface cables, etc.), discharge all circuits, and verify there are no hazardous voltages present on any conductors by measurements with a properly-operating voltage-sensing device before touching any internal parts. Verify the voltage-sensing device is working properly before and after making the measurements by testing with known-operating voltage sources and test for both DC and AC voltages. Do not attempt any service or adjustment unless another person capable of rendering first aid and resuscitation is present. Do not insert any object into an instrument's ventilation openings or other openings.

⚠ WARNING

Hazardous voltages may be present in unexpected locations in circuitry being tested when a fault condition in the circuit exists.

Fuse replacement

WARNING

Fuse replacement must be done by qualified service-trained maintenance personnel who are aware of the instrument's fuse requirements and safe replacement procedures. Disconnect the instrument from the power line before replacing fuses. Replace fuses only with new fuses of the fuse types, voltage ratings, and current ratings specified in this manual or on the back of the instrument. Failure to do so may damage the instrument, lead to a safety hazard, or cause a fire. Failure to use the specified fuses will void the warranty.

Servicing

CAUTION

Do not substitute parts that are not approved by B&K Precision or modify this instrument. Return the instrument to B&K Precision for service and repair to ensure that safety and performance features are maintained.

Cooling fans

CAUTION

This instrument contains one or more cooling fans. For continued safe operation of the instrument, the air inlet and exhaust openings for these fans must not be blocked nor must accumulated dust or other debris be allowed to reduce air flow. Maintain at least 25 mm clearance around the sides of the instrument that contain air inlet and exhaust ports. If mounted in a rack, position power devices in the rack above the instrument to minimize instrument heating while rack mounted. Do not continue to operate the instrument if you cannot verify the fan is operating (note some fans may have intermittent duty cycles). Do not insert any object into the fan's inlet or outlet.

Use correctly sized wires

WARNING

To connect a load to the power supply, use a wire diameter large enough to handle the maximum continuous output short-circuit current of the power supply without the wire overheating.

For continued safe use of the instrument

- Do not place heavy objects on the instrument.
- Do not obstruct cooling air flow to the instrument.
- Do not place a hot soldering iron on the instrument.
- Do not pull the instrument with the power cord, connected probe, or connected test lead.

Do not move the instrument when a probe is connected to a circuit being tested.

Compliance Statements

Disposal of Old Electrical & Electronic Equipment (Applicable in the European Union and other European countries with separate collection systems)



This product is subject to Directive 2002/96/EC of the European Parliament and the Council of the European Union on waste electrical and electronic equipment (WEEE), and in jurisdictions adopting that Directive, is marked as being put on the market after August 13, 2005, and should not be disposed of as unsorted municipal waste. Please utilize your local WEEE collection facilities in the disposition of this product and otherwise observe all applicable requirements.

CE Declaration of Conformity

The power supply meets the requirements of 2006/95/EC Low Voltage Directive and 2004/108/EC Electromagnetic Compatibility Directive with the following standards.

Low Voltage Directive

- EN61010-1: 2001

EMC Directive

- EN 61000-3-2: 2006
- EN 61000-3-3: 1995+A1: 2001+A2: 2005
- EN 61000-4-2 / -3 / -4 / -5 / -6 / -11
- EN 61326-1: 2006

Safety Symbols













	Refer to the user manual for warning information to avoid hazard or personal injury and prevent damage to instrument.
	Electric Shock hazard
	On (Supply). This is the AC mains connect/disconnect switch on the front of the instrument.
	Off (Supply). This is the AC mains connect/disconnect switch on the front of the instrument.
	DC current
	Alternating current
	Fuse Symbol
	Chassis (earth ground) symbol
	Ground terminal
	Protective earth ground
	CAUTION indicates a hazardous situation which, if not avoided, will result in minor or moderate injury
	WARNING indicates a hazardous situation which, if not avoided, could result in death or serious injury
	DANGER indicates a hazardous situation which, if not avoided, will result in death or serious injury.

Table of Contents

Safety Summary	i
Compliance Statements	vii
Safety Symbols	ix
1 General Information	1
1.1 Product Overview.....	1
1.2 Package Contents	1
1.3 Product Dimensions	2
1.4 Front Panel Overview	4
<i>Front Panel Description</i>	4
1.5 Rear Panel Overview	6
<i>Rear Panel Description</i>	6
1.6 Display Overview	7
<i>Display Description</i>	7
2 Getting Started	8
2.1 Input Power and Fuse Requirements.....	8
<i>Input Power</i>	8
<i>Fuse Requirements</i>	10
<i>Fuse Replacement</i>	11
2.2 Output Connections	12
2.3 Preliminary Check.....	13
<i>Self-test Errors</i>	13
<i>Output Check</i>	14
<i>Check Model and Firmware Version</i>	15
3 Front Panel Operation	16
3.1 Menu Options.....	16
<i>How to Access the Menu</i>	16
3.2 Configure Voltage and Current Output	17
<i>Setting Voltage</i>	17
<i>Setting Current</i>	18
<i>Remote Sense</i>	18

3.3	Protection Settings	20
	<i>Configure Over Voltage Protection (OVP)</i>	20
	<i>Configure Maximum Power Limit</i>	21
3.3	SYSTEM Menu	22
	<i>Restore Factory Default Settings</i>	22
	<i>Configure Power-On State</i>	23
	<i>Configure Trigger Source</i>	23
	<i>Save/Recall Instrument Settings</i>	24
	<i>Enable/Disable Key Sound</i>	25
	<i>Remote Interface Setup</i>	25
	<i>Return Meter</i>	29
3.4	CONFIG Menu.....	29
	<i>Load Setup Option</i>	29
	<i>External Analog Control</i>	30
	<i>Configure Voltage Limit</i>	35
	<i>Parallel/Series Connection</i>	36
	<i>Connection and Setup</i>	36
3.5	Program Sequence Mode (List mode).....	39
	<i>Configure Sequence Parameters</i>	40
	<i>Configure Program (List)</i>	44
	<i>Recall and Run Program</i>	46
3.6	9115-AT Automotive Test Functions	48
	<i>DIN 40839 Parameters</i>	48
	<i>ISO 16750-2 Parameters</i>	50
3.7	Configure Voltage Slope	56
3.8	Key Lock	57
4	Remote Operation.....	58
4.1	Interface Connection.....	58
	<i>RS-232</i>	58
	<i>GPIB</i>	58
	<i>RS-485</i>	59
	<i>USBTMC</i>	59
	<i>Ethernet (LAN)</i>	59

4.2	Remote Commands	60
5	Troubleshooting Guide	61
	<i>General</i>	61
	<i>Remote Control</i>	61
6	Specifications	62
7	Calibration.....	63
	SERVICE INFORMATION.....	64
	LIMITED ONE-YEAR WARRANTY	65

1 General Information

1.1 Product Overview

B&K Precision models 9115, 9115-AT, 9116, and 9117 are multi-range single output high power supplies with the capability of producing up to 80 V or 60 A (9115/9115-AT), 150 V or 30 A (9116), and 80 V or 120 A (9117) at a maximum power output of 1200 W (3000 W for 9117). With an easy-to-read VFD display, user-friendly controls and a numeric keypad that allows for easy configurations from the front panel. Standard RS232, USB, GPIB, RS485, and Ethernet (9117 only) interfaces included on the rear panel provide flexibility for remote operation of the power supply. Its compact 1U (2U for 9117) size form factor makes it ideal for use in a standard 19-inch rack.

Features:

- Multi-ranging operation provides voltage and current flexibility
- Compact, high density 1U rackmount form factor (2U for model 9117)
- High programming and readback resolution of 1mV/1mA (2mV/3mA for model 9117)
- Standard USBTMC, GPIB, RS232, RS485, and Ethernet (model 9117 only)
- External analog interface with control and monitoring functions
- Master/Slave Mode for series and parallel connectivity
- Adjustable voltage slope (rise and fall time)
- Sequence programming (models 9115/9115-AT/9116 only)
- OVP and OPP protection

1.2 Package Contents

Please inspect the instrument mechanically and electrically upon receiving it. Unpack all items from the shipping carton, and check for any obvious signs of physical damage that may have occurred during transportation. Report any damage to the shipping agent immediately. Save the original packing carton for possible future reshipment. Every power supply is shipped with the following contents:

- **1 x 9115, 9115-AT, 9116, or 9117 Power Supply**
- **1 x User Manual**
- **1 x AC Power Cord (models 9115, 9115-AT, and 9116 only)**
- **1 x Unterminated Power Cord (model 9117 only)**
- **1 x AC Input Connector (model 9117 only)**
- **1 x Certificate of Calibration**
- **1 x Test Report**

Verify that all items above are included in the shipping container. If anything is missing, please

contact B&K Precision.

1.3 Product Dimensions

The 9115, 9115-AT, and 9116 power supply's dimensions (WxHxD) are approximately 414.5 mm x 44.5 mm x 483.2 mm (16.29" x 1.75" x 19.02"). It is designed to fit in a standard 19-inch rackmount and is of 1U size.

The 9117 power supply's dimensions (WxHxD) are approximately 436.5 mm x 89.3 mm x 532 mm (17.19" x 3.52" x 20.95"). It is also designed to fit in a standard 19-inch rackmount and is of 2U size.

Note: All dimensions in the figures below are measured in millimeters (mm).

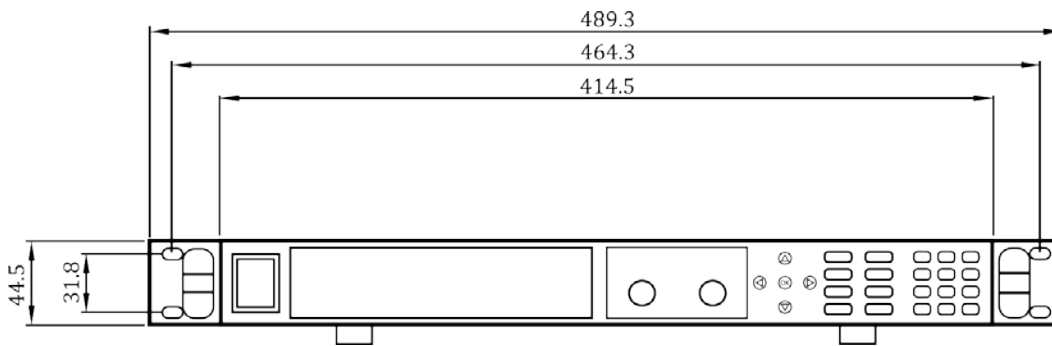

Figure 1.1 - Front Panel View for 9115/9115-AT/9116

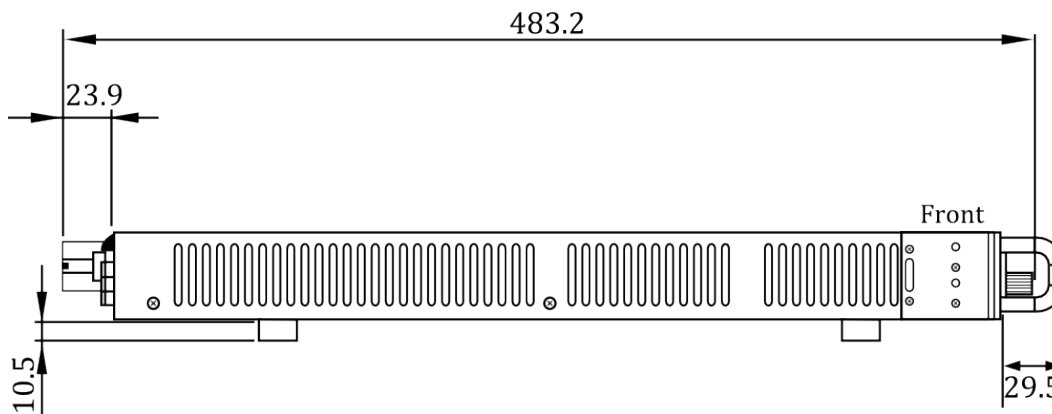

Figure 1.2 - Side View for 9115/9115-AT/9116

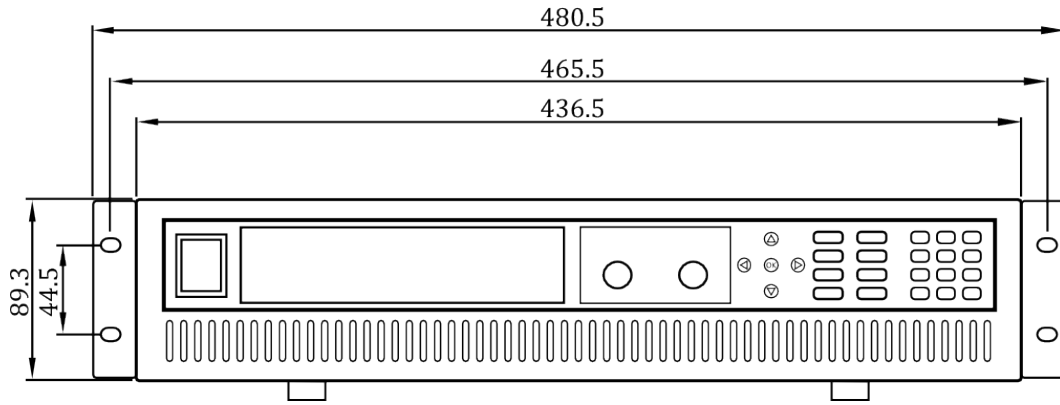

Figure 1.3 - Front View for 9117

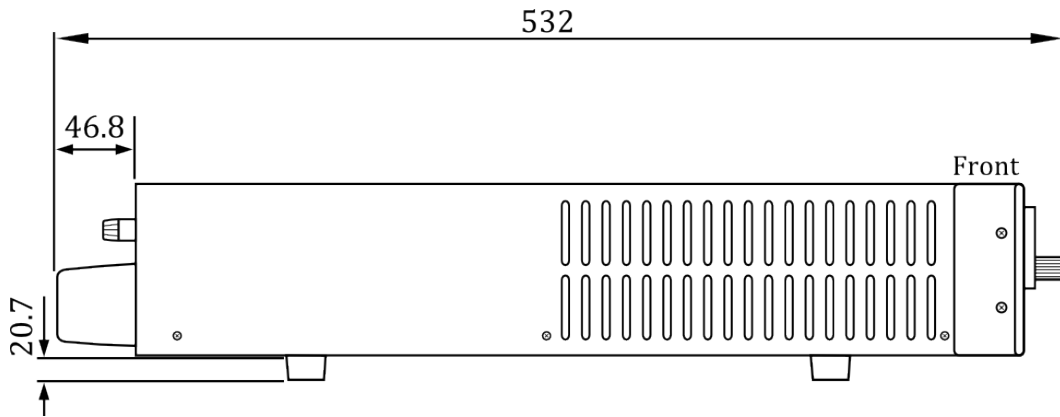

Figure 1.4 - Side View for 9117

1.4 Front Panel Overview

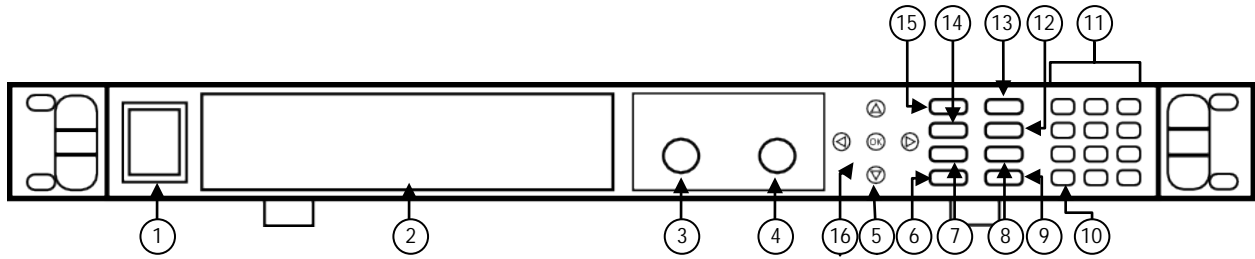

Figure 1.5 - Front Panel for 9115/9115-AT/9116

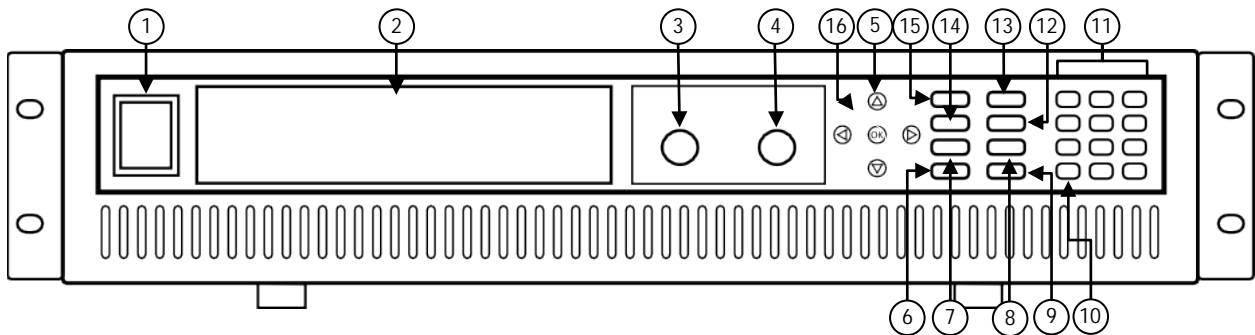







Figure 1.6 - Front Panel for 9117

Front Panel Description

①		Power On/Off switch
②		VFD display
③		Voltage adjust knob
④		Current adjust knob
⑤		Up/Down/Left/Right arrow keys <i>Used to adjust cursor location and selecting menu items.</i>
⑥		On/Off / Lock button <i>Control the output state or locks the front panel button.</i>
⑦		Save/Recall button <i>Used to save and recall instrument settings.</i>
⑧		Meter display toggle / Local button <i>Used to toggle display between setting and measured voltage and current or</i>

to set the instrument back to local mode.

⑨



Enter / Trigger button

Used to confirm setting/parameter changes or to provide a single trigger for list operation.

⑩



Escape button

Used to exit menu settings.

⑪

Numeric keypad

⑫



I-set / P-max button

Used to configure output current or set the maximum power output limit.

⑬



OVP set button

Used to configure over voltage protection (OVP) value.

⑭



V-set / Slope button

Used to configure output voltage or set the rise and fall time of the output voltage.

⑮



Shift key

Enables access to secondary functions of some buttons (These functions are labeled in white)

⑯



OK button

(same as Enter button)

1.5 Rear Panel Overview

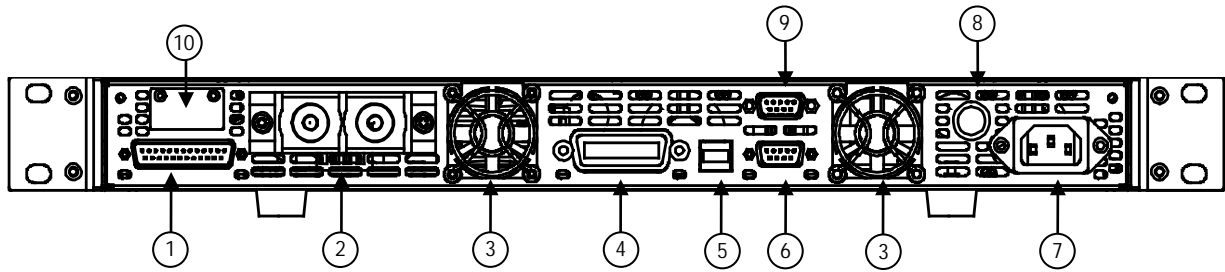

Figure 1.7 - Rear Panel for 9115/9115-AT/9116

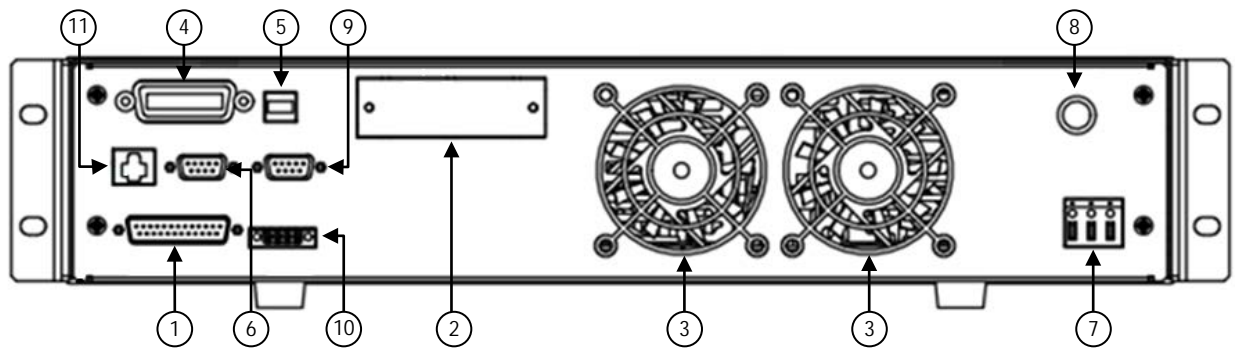

Figure 1.8 - Rear Panel for 9117

Rear Panel Description

- | | |
|---|--|
| ① | Analog Control Interface |
| ② | Output Terminal |
| ③ | Rear Cooling Fan |
| ④ | GPIB Interface |
| ⑤ | USB Interface |
| ⑥ | RS-232 Interface |
| ⑦ | AC Input Receptacle |
| ⑧ | Fuse Box |
| ⑨ | RS-485 Interface |
| ⑩ | Remote Sense Terminals |
| ⑪ | Ethernet (LAN) Interface (Model 9117 only) |

1.6 Display Overview

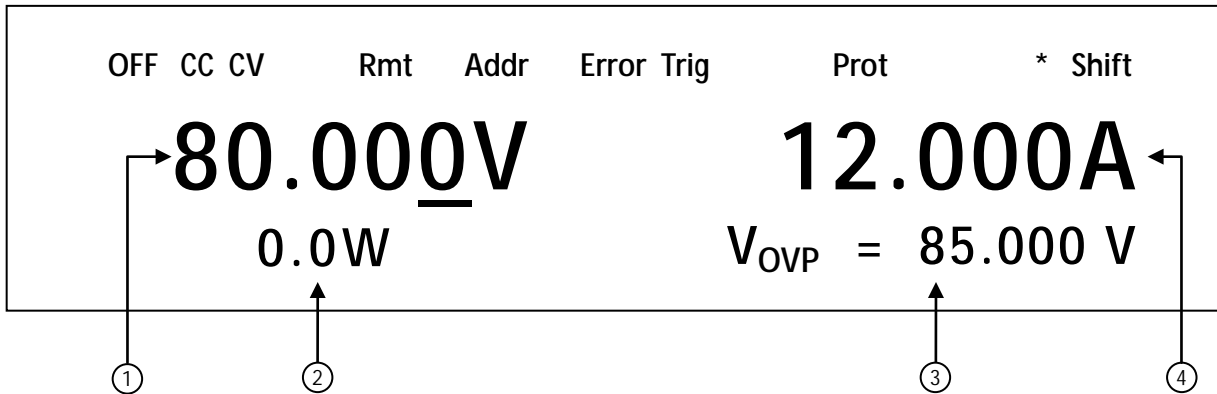

Figure 1.9 – Display Overview

Display Description

①	Setting/Measured Voltage
②	Measured Power Output
③	Settings Display <i>Displays parameter settings such as OVP, P-max, Rise/Fall</i>
④	Setting/Measured Current
OFF	Indicates output is disabled
CC	Indicates constant current (CC) operation
CV	Indicates constant voltage (CV) operation
Rmt	Indicates remote mode
Addr	Indicates remote communication activity
Error	Indicates an error has occurred
Trig	Indicates waiting for trigger (for list operation)
Prot	Indicates protection trip for over voltage or over temperature
*	Indicates key lock is enabled
Shift	Indicates shift mode (for access to secondary button functions)

2 Getting Started

Before connecting and powering up the instrument, please review and go through the instructions in this chapter.

2.1 Input Power and Fuse Requirements

Input Power

Before connecting to an AC outlet or external power source, be sure that the power switch is in the OFF position and verify that the AC power cord, including the extension line, is compatible with the rated voltage/current and that there is sufficient circuit capacity for the power supply. Once verified, connect the cable firmly.

⚠ WARNING

The included AC power cord is safety certified for this instrument operating in rated range. To change a cable or add an extension cable, be sure that it can meet the required power ratings for this instrument. Any misuse with wrong or unsafe cables will void the warranty.

For Models 9115(-AT) and 9116

The supply has a universal AC input that accepts line voltage input within:

AC Input: 115 V (+/-10%) or 230 V (+/- 10 %)

Frequency: 47 Hz – 63 Hz

⚠ WARNING

Do NOT plug the AC power cord into the wall socket prior to connecting ALL three AC power wires to the rear panel and securely mount the safety metal housing over the input receptacle. Doing so may create a shock hazard.

SHOCK HAZARD

The power cord provides a chassis ground through a third conductor. Verify that your power outlet is of the

three-conductor type with the correct pin connected to earth ground.

⚠ CAUTION

Connection of this power supply to an AC power source should be made by a qualified electrician or other qualified personnel. Incorrect wiring may damage the power supply or cause a fire hazard

For Model 9117

The supply uses a 3-wire AC input terminal which accepts the following line voltage input:

AC Input: 220 V (+/-10%), single phase

Frequency: 47 Hz – 63 Hz

Follow the instructions below to connect the 3 wires of the AC power cable to the AC input of the power supply in the rear panel.

1. Remove the safety metal housing (held in place with one screw) to reveal the 3 wire AC connector port on the rear panel of the power supply.
2. Connect the input receptacle (green terminal block) to the input terminals on the rear of the power supply.
3. Feed the 3 wire AC power cord through the front hole of the safety metal housing.
4. Loosen the screws on the green terminal block to insert each wire into its designated place. Then tighten each screw terminal so that the wires are securely in place.
5. Align the metal housing mounting hole on the right side to the screw hole on the power supply so that the AC receptacle on the rear panel is covered, and screw in place.
6. Be sure to use the included screw to fasten and secure the cable housing assembly.

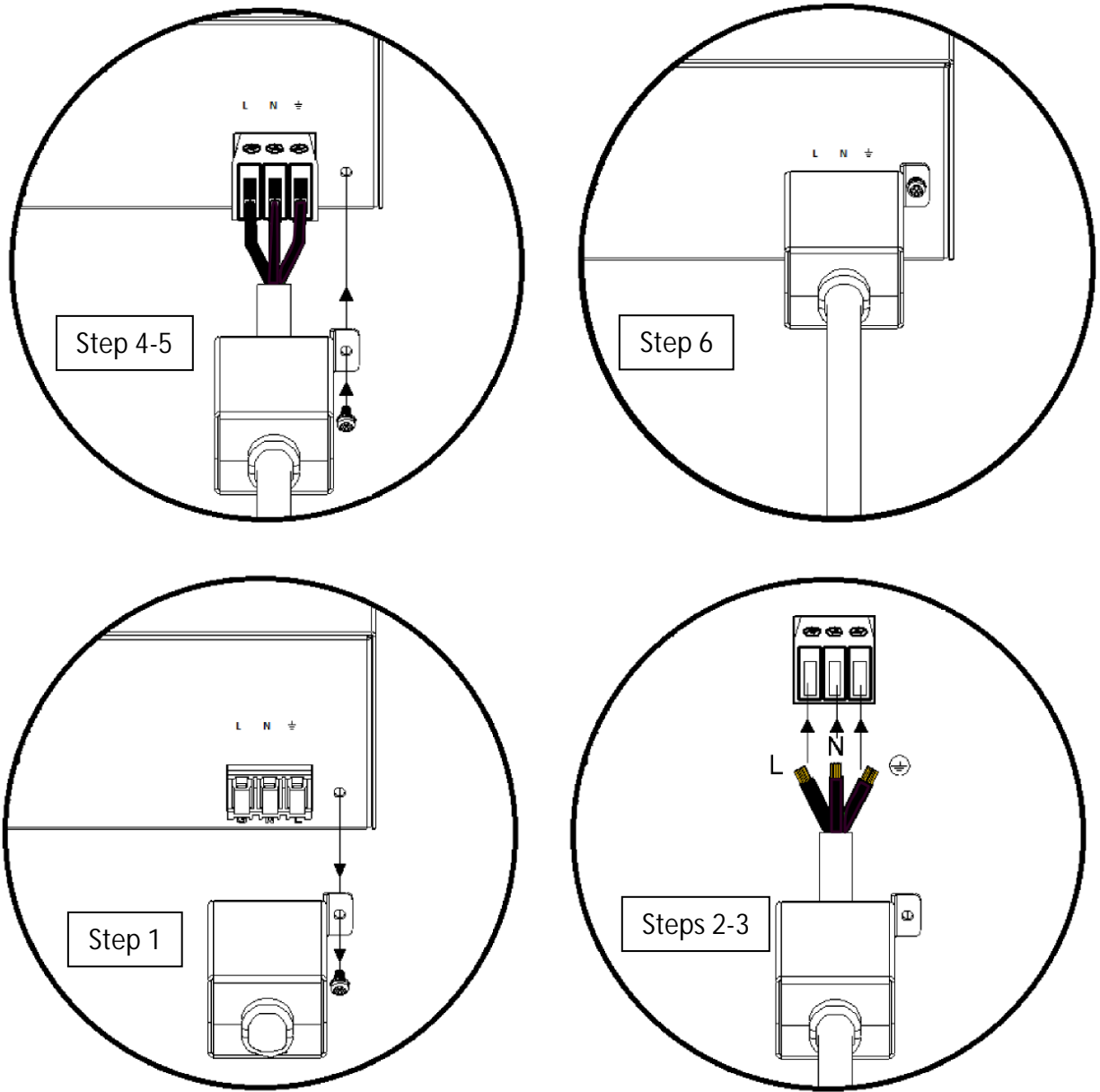

Figure 2.1 – AC Power cable housing assembly

Follow the instructions below to connect the AC power cord to the AC supply mains distribution.

Single-phase mains connections

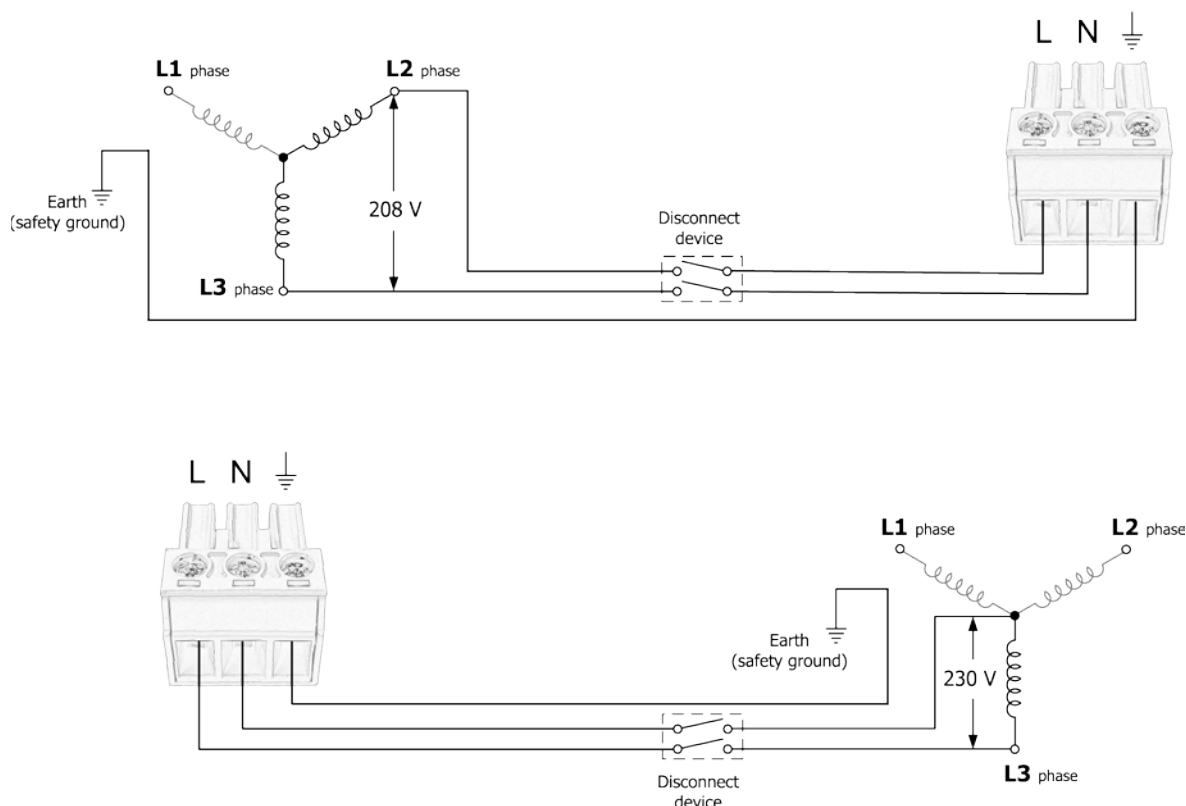

Figure 2.2 – Connecting to Mains Distribution (Top) Phase-to-Phase, (Bottom) Phase-to-Neutral

Fuse Requirements

An AC input fuse is necessary when powering the instrument. Refer to the table below for the fuse requirements.

Model	Fuse Description
9115	15AT / 250V (6 x 32 mm slow blow ceramic tube fuse)
9115-AT	15AT / 250V (6 x 32 mm slow blow ceramic tube fuse)
9116	15AT / 250V (6 x 32 mm slow blow ceramic tube fuse)
9117	20AT / 250V (6 x 32 mm slow blow ceramic tube fuse)

Table 2.1 – AC Input Fuse Table

Fuse Replacement

Follow the steps below to replace or check the fuse.

1. Locate the fuse box in the rear panel, next to the AC input receptacle.

2. Use a flat blade screwdriver and turn the fuse capsule counter-clockwise. There is an internal spring that will push it out after turning a few times.
3. Pull out the glass tube fuse inside to check and replace as necessary.
4. Insert the fuse capsule in the same location and use the flat blade screwdriver to turn clockwise.
5. The fuse capsule will now be locked and secured.

Note: For model 9117, the fuse capsule is hand fastened, so no flat blade screwdriver is needed.

2.2 Output Connections

The main DC output terminal is a screw type terminal located in the rear panel. Figure 9 below illustrates the size and dimensions of the terminal. To loosen, use hex key #4 size screwdriver.

Note: The screws on the terminals can be completely removed to allow for ring type adapters (must be greater than 6mm in diameter).

⚠ WARNING

Before connecting wires to the output terminals, turn OFF the power supply to avoid damage to the instrument and the device under test (DUT). For safety, load wires must have a wire gauge size large enough to prevent overheating when the power supply operates at maximum short circuit output current. It will also prevent large voltage drops from resistances in the wires.

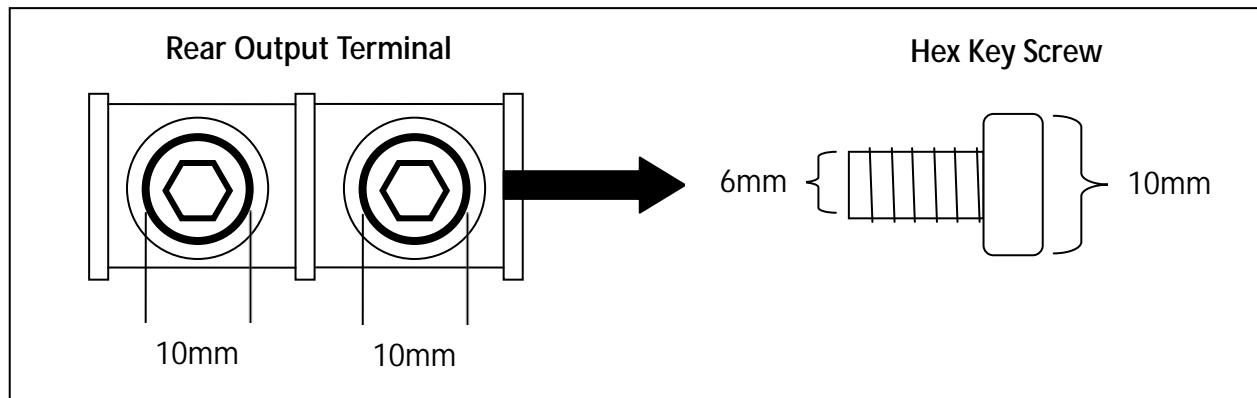

Figure 2.3 - Rear Output Terminal

Due to the high current rating of the power supply, proper wire sizes are necessary for safe connectivity and to prevent wires from overheating. Refer to the table below as a reference for proper wire sizes according to the amount of current used for operation:

Table 2.2 - Wire Gauge Rating

AWG	6	8	10	12	14	16	18	20	22
I _{max} (A)	75	55	40	25	20	13	10	7	5
mΩ/meter	1.3	2.1	3.3	5.2	8.3	13.2	21	33.5	52.8

2.3 Preliminary Check

Complete the following steps to verify that the power supply is ready for use.

1. **Verify AC Input Voltage**
Verify and check to make sure proper AC voltages are available to power the instrument. The AC voltage range must meet the acceptable specification as explained in "2.1 Input Power and Fuse Requirements".
2. **Connect Power and Self-Test**
Connect AC power cord to the AC receptacle in the rear panel and press the power switch to the | (ON) position to turn ON the instrument. It will run through a self-test procedure with the screen shown in below:



Self-test Errors

The following errors will be displayed if self-test did not complete successfully:





Error Message on Display	Description
EEPROM FAILURE	The internal EEPROM is corrupted or damaged.
Config Data Lost	The last operation data within the EEPROM is lost.
Calibration Data Lost	Calibration data within the EEPROM is lost.
FactoryCal.Data Lost	Factory calibration data is lost.
MainframeInitialize Lost	The system settings within the EEPROM is lost.

If any of these errors occur, please contact B&K Precision.

Output Check







Voltage Check

Follow the steps below to check basic voltage output with no load connected.

1. Turn on the power supply. The display will show the **OFF** annunciator above the voltage display.
2. Enable the output by pressing , and the button will be lit. The **OFF** annunciator will change to **CV**.
3. Using the numeric keypad or the voltage adjust knob and enter a voltage value. The voltage display will now show the value you entered. If entering with numeric keypad, press  first, then enter the value and press .
4. If the  button is not already lit, press it once and the voltage display will show the measured voltage at the output, which may fluctuate slightly from the voltage value entered in the previous step.
5. (Optional) You may also verify the output voltage by connecting the (+) and (-) terminals on the rear panel to an external voltmeter. The measured value should match or be within the entered voltage value.

Current Check

Follow the steps below to check basic current output of the power supply.

1. Turn on the power supply. The display will show the **OFF** annunciator above the voltage display. Be sure that the output is disabled (the  should not be lit when it is off). If not, press  to disable output.
2. Short the (+) and (-) output terminals with test leads, shorting bar, or clip. (Refer to "Table 2.2 - Wire Gauge Rating" to select appropriate test leads)
3. Using the numeric keypad or the current adjust knob, enter a small current value (i.e. 1.000 A). If entering with numeric keypad, press  first, then enter the value and press . The current display will now show the value you entered.
4. Enable the output by pressing , and the button will be lit. The **OFF** annunciator will change to **CC**.
5. If the  button is not already lit, press it once and the current display will show the measured current at the output, which may fluctuate slightly from the current value entered in step 3.
6. (Optional) You may also verify the output current by connecting either the (+) and (-) terminals on the rear panel to an external current meter capable of measuring the current that you set. The measured value should match or be within the entered current value.

7. Press the power switch to \bigcirc (OFF) position to turn off the power supply and remove the short on the output terminals.

Check Model and Firmware Version

The model and firmware version can be verified by using the *IDN? query remote command. It can also be found from within the menu system by following these steps:

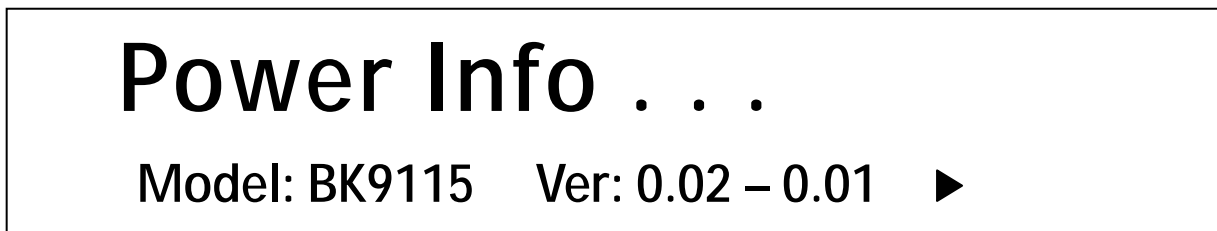

1. Press **Shift** and press **Menu** **OVP** to enter the menu system.
2. Press the **▶** arrow three times until **INFO** is blinking. Press **OK**, and the display will show the following screen:



3. The model is shown above as BK 9115, and the firmware version is shown as 0.02 – 0.01.
4. Press **Esc** twice to exit the menu and return to the normal display.

3 Front Panel Operation

3.1 Menu Options

All settings and parameters can be configured from the built-in menu system of the power supply. To access the menu, press  and press .

The menu system is divided into the following sections and organized as follows:

SYSTEM

Initialize	Reset power supply settings to factory default values.
Power-On	Configure power-on state.
Trigger	Configure Trigger.
Memory	Select memory location for save/recall instrument settings.
Buzzer	Enable/Disable key sound.
Communication	Select communication interface.
ReturnMeter	Enables automatic delay to switch display from setting to measured value (meter).

CONFIG

Load	Enables dummy load to increase speed of voltage fall time.
Ext-Ctrl	Configures external analog control.
Limit	Configures voltage setting limits.
Online	Configures series/parallel connection and master/slave mode.

LIST¹

Off	
Recall	Recall list file.
EditList	Configure list operation.
EditSeq	Configure sequence operation.

FUNC²





LIST	Setup the LIST operation
DIN40839	Configure a DIN40839 test
ISO16750-2	Configure a ISO16750-2 test
INFO	Show model, firmware version, and serial number.

¹ Available on models 9115/9115-AT and 9116 only









² Available on model 9115-AT only (LIST mode can be found in the menu)

How to Access the Menu

Before using the instrument, it is important to be familiarized with its menu structure and learn how to view or change settings and parameters. Follow the steps below to guide you in selecting menu options.

1. From the normal display, press  and press  to enter the menu.
2. The selected item will be blinking. Use   keys to move through the menu selections.
3. When the desired menu section is blinking, press  to access its menu settings.
4. Below is the display when **SYSTEM** is selected.







5. The selected item will be blinking. Use   keys to move through the menu items. When there is a  on the right side of the display, that means there are more menu items available to select from. Similarly, a  will appear on the left side of the display when there are menu items to the left. Use the   keys accordingly to select the desired menu item.
6. Press  to access the selected menu item.
7. There may be parameters or options to select within each menu item. Follow the same instructions as described in the previous steps to select them. To save changes to a setting, press .
8. To exit the menu at any time, press  twice.

3.2 Configure Voltage and Current Output

Voltage and current can be set from the front panel. Remote sense is also available on the rear panel for voltage compensation at the output.

Setting Voltage





Follow the steps below to set the output voltage:

1. From the normal front panel display, users can use either the voltage adjust knob or the numeric keypad to enter the setting voltage.
2. If entering using numeric keypad, press  first so that the cursor selects the voltage display. Then, enter the value and press  to set the voltage.
3. To change the cursor position to adjust with the voltage adjust knob, use the   keys to move left or right.

Note: To see the changes to the setting voltage, be sure the display is not showing the measured voltage. This can be checked by looking at the  button backlight. If it is not lit, display is showing setting voltage.

Setting Current

Follow the steps below to set the output current:

1. From the normal front panel display, users can use either the current adjust knob or the numeric keypad to enter the setting current.
2. If entering using numeric keypad, press  first so that the cursor selects the current display. Then, enter the value and press  to set the current.
3. To change the cursor position to adjust with the voltage adjust knob, use the   keys to move left or right.

Note: To see the changes to the setting current, be sure the display is not showing the measured current. This can be checked by looking at the  button backlight. If it is not lit, display is showing setting current.

Remote Sense

Remote sense can be used to compensate for voltage drops (up to 1 V) due to resistance from test leads connected to your device under test (DUT), thus providing more accurate output voltage. The power supply is initially setup to local sense mode by default. Refer to the following sections for details of local and remote sense setup.

Local Sense

By default, the power supply is setup for local sense. This is determined by the wire connections in the rear panel, illustrated below:

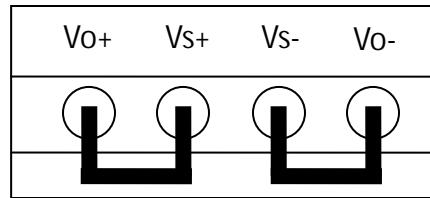

Figure 3.1 – Local Sense Connection Diagram

⚠ WARNING

DO NOT disconnect the wires if remote sense is not used. Doing so will cause erratic behavior and may damage the power supply under certain conditions.

Never connect any power source into any of the four terminals at any time during operation.

When output is enabled, DO NOT use your hands to touch the terminals or the screws that are designed to tighten wires to the terminals. Doing so may create a shock hazard under high voltage output conditions.

Remote Sense

To enable remote sense, follow the steps below:

1. Power OFF the supply and disconnect all loads and cables connected to it.
2. Use a small flat blade screwdriver to loosen the wire connection connected between **Vo+** and **Vs+** and **Vs-** and **Vo-**.
3. Connect the **Vs+** to the DUT's positive (+) terminal, and connect the **Vs-** to the DUT's negative (-) terminal.
4. Do not connect any wires to **Vo+** and **Vo-** terminals.
5. Power ON the power supply, and then configure and enable the output. The setup should look like the below figure:

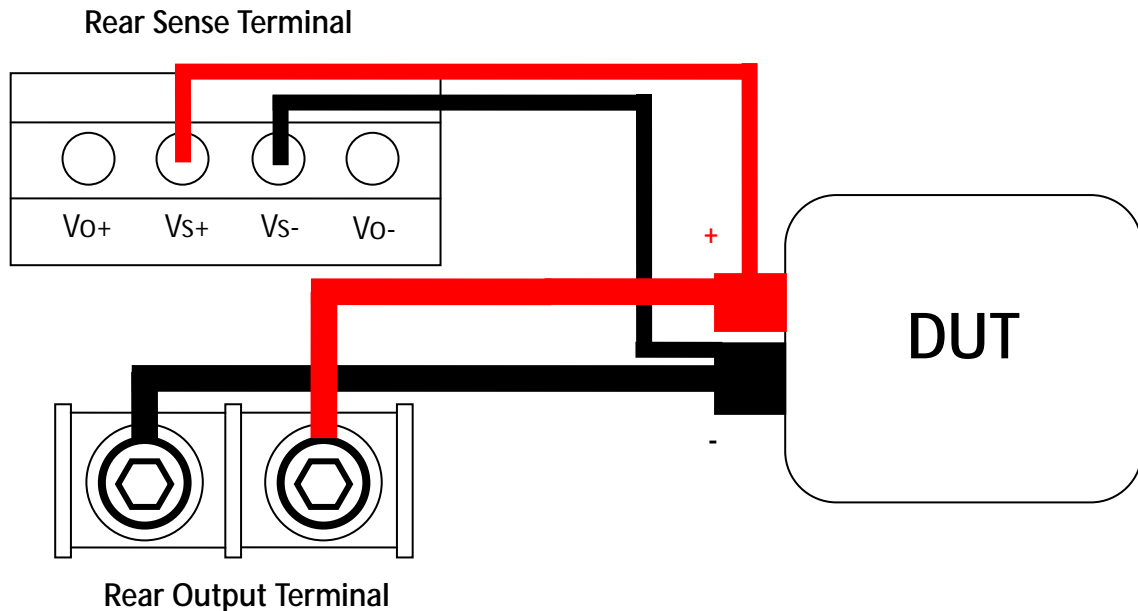

Figure 3.2 – Remote Sense Connection Diagram





⚠ WARNING

DO NOT at any time disconnect the wires from the Vs+ and Vs- terminals to the DUT while output is enabled (ON). Doing so may damage the power supply and cause unstable output.

3.3 Protection Settings

Configure Over Voltage Protection (OVP)

Follow the steps below to set the OVP limit:

1. Press the  button. The display will show V_{OVP} on the bottom right. Use the voltage adjust knob or the numeric keypad to enter the OVP limit.
2. Press  to save the change. The display will then show T_{OVPdly} . This parameter specifies the delay time to which to activate OVP.
3. Use the voltage or current adjust knob or the numeric keypad to enter a value. This can be from **1 ms – 600 ms**.
4. Press  to save the change. OVP is now configured. Notice the  backlight will turn on. This means OVP is enabled.

5. To disable OVP at any time, just press  twice. When it is disabled, the backlight will disappear.







When OVP protection is tripped, the following screen will display:



To clear the trip status, press  once.

Configure Maximum Power Limit

Follow the steps below to set the maximum power limit:



1. Press  and then . The display will show P_{max} on the bottom right. Use the voltage or current adjust knob or the numeric keypad to enter the maximum power output limit.
2. Press  to save the change.
3. Use the voltage or current adjust knob or the numeric keypad to enter a value. This can be from **1 ms – 600 ms**.
4. Press  to save the change. OVP is now configured. Notice the  backlight will turn on. This means OVP is enabled.
5. To disable OVP at any time, just press  twice. When it is disabled, the backlight will disappear.

When the output reaches the power maximum limit, the over power protection is tripped and the following screen will display:



To clear the trip status, press  once.

3.3 SYSTEM Menu

All setup procedures and settings explained in this section can be accessed from the **SYSTEM** menu. To access this menu, press  and press . When **SYSTEM** is blinking, press .

Restore Factory Default Settings

All instrument settings can be reset back to their factory default values by doing the following:

CAUTION

Restoring the instrument to factory default will change all current instrument settings and parameters back to their default values.

1. From the **SYSTEM** menu, select **Initialize** and press .
2. The instrument will return to the normal display and all settings are now restored back to factory default. The below table lists some of the factory default settings.





Table 3.1 - Factory Default Settings

Communication Address	0
Key Sound	ON
Trigger Mode	Manual
Communication Interface	RS232
RS232 Settings	4800, 8, N, 1
Return Meter	Off
Memory	Group 0

Power-On	Rst
Load Setup	Off
External Control	10v-M
Limit	Vmin = 0.000V, Vmax = 81.000V
Online Setup	Off
Output	Disabled







Configure Power-On State

The initial power-On state of the power supply can be configured by following the steps below:

1. From the **SYSTEM** menu, select **Power-On** and press  .
2. There are two options:
Rst(Def) – Factory Default.
Sav0 – Settings before last power up.
3. Select the settings you want during power up, and press   to save changes.
4. To exit the menu at any time, press  twice.

Configure Trigger Source

The trigger function is used to initiate the start of running a program sequence (list). The trigger source can be set so that users can send a trigger from the front panel or through a remote command via remote interface. Follow the below steps to configure the trigger mode:

1. From the **SYSTEM** menu, browse and select **Trigger** and press  .
2. There are two options:
Manual(Def) – Manual trigger. Front panel trigger button is used to send a trigger (press  and   to send trigger).
Bus – Bus trigger. Remote command ***TRG** is used to send a trigger.
3. To exit the menu at any time, press  twice.



Save/Recall Instrument Settings

The instrument can save up to 100 instrument settings in non-volatile memory. Memory is allocated in 10 different storage groups (group 0 to 9), and each group has 10 memory locations to store settings (0 to 9). The memory group must be selected from the menu first, before settings can be saved within the group.



Select Storage Group

1. From the **SYSTEM** menu, browse and select **Memory** and press . The following screen will appear.



2. Use the current adjust knob or the numeric keypad to enter the storage group. Select between **0 – 9**. Press  to save selection.
3. To exit the menu at any time, press  twice.

Save Settings

1. Set up all the instrument settings that you want to save.
2. Then, press  and . The display will show the following:



3. Use the current adjust knob or the numeric keypad to enter the memory location in which to store current instrument settings. Select between **0 – 9**. Press  to save to the selection location.
4. If it saved successfully, there will be a message on display: **Save Success!**

Recall Settings



1. Press . Notice the button will be lit and the cursor on the display will disappear. This indicates **Recall** mode. Instrument settings can only be recalled when the instrument enters this mode.
2. Use the keypad to enter the memory location you want to recall. Enter between **0 to 9**.
3. Once entered, the saved settings at the location will be immediately recalled.

Note: When in Recall mode, users can recall settings from different locations without having to press additional keys each time. For example, you can press 1 to recall settings in location one, and then press 5 to recall settings in location 5 on the fly.

4. To exit **Recall** mode, press  and it will no longer be lit. The cursor on the display will reappear, indicating that the instrument is no longer in **Recall** mode.

Enable/Disable Key Sound



The instrument initially has key sound enabled from factory. To disable or re-enable the key sound, follow the steps below:

1. From the **SYSTEM** menu, browse and select **Buzzer** and press .
2. Select between the two options:
On(Def) – Enable key sound
Off – Disable key sound
3. Select the desired option and press  to save the change.
4. To exit the menu at any time, press  twice.

Remote Interface Setup



There are several interfaces available for remote communication: USBTMC, GPIB, RS-232, Ethernet and RS-485. This section will describe how to setup all the supported interfaces.

Note: The **RMT** indicator will appear on display when the power supply is successfully connected to a PC remotely through any remote interface. Keys on the front panel will be locked until the instrument is in LOCAL mode. To return to LOCAL mode from the front panel,

press  and . The **RMT** indicator will disappear when the instrument is in LOCAL mode.





RS-232

Follow the steps below to configure the power supply for RS-232 operation:

1. From the **SYSTEM** menu, browse and select **Communication** and press .
2. Select **RS-232(Def)** and press  to set to RS-232 for remote communication. The following display will be shown:

RS232

4800 , 8 , N , 1 , Addr . . .

3. **4800** is the baudrate; **8** is the data bits; **N** is the parity; **1** is the stop bit; **Addr...** is for address.
4. Use   to select between each serial settings, and use   to change the settings.
5. Below lists the options that can be changed for each setting:
Baudrate: 4800, 9600, 19200, 38400, 57600, 115200*
Data bits: 8
Parity: N (*None*), E (*Even*), O (*Odd*)
Stop bit: 1, 2
Addr: 0 to 31



Note: The default is 4800, 8, N, 1, Address = 0.

*Setting the baudrate to 115200 may cause unstable results during remote communication. Select a lower baudrate if communication errors occur.

6. All serial settings must match with the settings configured on the PC in order for communication to link successfully.

USBTMC





A **USB Type A to Type B cable** (i.e. USB printer cable) is required to connect the USB port in the rear panel to a PC. Follow the steps below to setup the power supply for remote communication.

1. From the **SYSTEM** menu, browse and select **Communication** and press .
2. Select **USB** and press  to set to USBTMC for remote communication.
3. Install the USB driver. For Windows® 7 users, this may install automatically. For other users, visit www.bkprecision.com to download the driver.

Note: Users who have LabVIEW™ or NI-VISA installed will automatically have this driver in their system. In this case, driver download is not required.



GPIB

Follow the below instructions to select GPIB interface for remote operation.

1. From the **SYSTEM** menu, browse and select **Communication** and press .
2. Select **GPIB** and press  to set to GPIB for remote communication.
3. The display will give a prompt to select an **Address**. This is the GPIB address to which the power supply will be assigned to.
4. Use the current adjust knob or the numeric keypad to enter an address from 0 – 31.
5. Press  to save the selected address and the display will return to the **Communication** menu.
6. Press  several times to exit the menu.





RS-485

Multiple power supplies (up to 31) can be connected together in series and be controlled via the DB-9 RS-485 interface.

1. From the **SYSTEM** menu, browse and select **Communication** and press .
2. Select **RS485** and press  to set to RS485 for remote communication. The following display will be shown:



RS485

4800 , 8 , N , 1 , Addr . . .

3. **4800** is the baudrate; **8** is the data bits; **N** is the parity; **1** is the stop bit; **Addr...** is for address.
4. Use   to select between each serial settings, and use   to change the settings.
5. Below list the options that can be changed for each setting:
Baudrate: 4800, 9600, 19200, 38400, 57600, 115200*
Data bits: 8
Parity: N (*None*), E (*Even*), O (*Odd*)
Stop bit: 1, 2
Addr: 0 to 31

Note: The default is 4800, 8, N, 1, Address = 0.







***Setting the baudrate to 115200 may provide unstable results during remote communication. Select a lower baudrate if communication errors occur.**

6. Select **Addr...** and press . You will be prompted to enter an address. Use current adjust knob or numeric keypad to enter a number between 0 to 31, and then press .
7. For each power supply that you want to control, provide a different address. For example, if you have three power supplies to control, set the first supply to address 1, second supply to address 2, and third supply to address 3. If two or more supplies have the same address, the RS485 protocols will create communication errors.
8. Repeat the above steps for each power supply that you want to connect together and control, making sure that each of them have a different address assigned.
9. Press  several times to exit the menu.



Ethernet (Model 9117 only)

The Ethernet (LAN) interface supports a raw socket TCP/IP connection only. It does not support UDP protocols.



Follow the below instructions to select Ethernet interface for remote operation.

1. From the **SYSTEM** menu, browse and select **Communication** and press .
2. Select **Ethernet** and press .
3. Use   to cycle through the Ethernet settings.
4. Use the current adjust knob or the numeric keypad to change the desired address or value for each Ethernet settings.
5. Below lists the options that can be changed for each setting:
Gateway: 192.168.0.1
IP: 192.168.0.125
Mask: 255.255.255.0
Socket Port: 30000
6. Press  to save the selected address and the display will return to the **Communication** menu.
7. Press  several times to exit the menu.



Return Meter

This option allows users to enable an internal fixed timer delay (5 seconds) for the power supply to automatically switch from setting display to measured display. When enabled, if the power supply output state is ON (enabled) and if the display shows setting voltage and current, it will automatically switch to measured voltage and current display after 5 seconds. The backlight of the  button will also be lit. In this state, pushing the  again to toggle back to setting display will reset the 5-second timer again before the supply changes back to measured display.

To configure this option, follow the steps below:

1. From the **SYSTEM** menu, browse and select **ReturnMeter** and press .
2. Select between the two options:
Off(Def) – Return Meter function disabled.
Delay – Enables return meter function.
3. Select the desired option and press  to save the change.
4. To exit the menu at any time, press  twice.

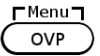
3.4 CONFIG Menu

All setup procedures and settings explained in this section can be accessed from the **CONFIG** menu. To access this menu, press  and press . Select **CONFIG**, then press .

Load Setup Option

The power supply has an internal dummy load that can be enabled to increase the speed of the voltage fall time for high speed test applications. The effectiveness of this function is dependent on the DUT (device under test) and may or may not be useful for some applications.



This feature should only be used with caution, as it is not designed for all applications.

DO NOT enable this function for applications such as connecting devices for battery charging or powering electric motors. All other applications that may behave similarly to these types of loads should NOT use this function. This function is disabled by default.

⚠ WARNING

DO NOT enable this function for battery test applications (i.e. battery charging) and all applications that may have a high charge. If a battery with a low voltage is connected to the power supply while the output is OFF (disabled), the dummy load will drain the battery. If the battery capacity is large and this function is enabled, a large current will flow and damage the power supply and the dummy load.

To enable or disable this function, follow the steps below:

1. From the **CONFIG** menu, select **Load** and press .
2. Select between the two options:
Off – Disables the dummy load (default).
On – Enables the dummy load.
3. Select the desired option and press  to save the change.
4. To exit the menu at any time, press  twice.

External Analog Control

The power supply output can be controlled and monitored by external DC voltage sources (0 – 5 V or 0 – 10 V) or resistances (0 – 5 k Ω or 0 – 10 k Ω).

Configure Monitoring Source



Follow the steps below to configure the source to use for monitoring.

Note: Voltage monitoring is on Pin 23 and current monitoring is on Pin 24 of the DB25 Analog interface.

1. From the **CONFIG** menu, browse and select **Ext-Ctrl** and press . The following screen will display:

Ext – Ctrl Setup

10v-M 10v/10k-P V-P Off

2. Select **10v-M** or **5v-M** so that it is blinking. Use the \blacktriangle \blacktriangledown keys to change between **10v-M** and **5v-M**. – 0 – 5 V scale is used for monitoring 0 – 100% of output.
10v-M – 0 – 10 V scale is used for monitoring 0 – 100% of output.
3. Press  when finished making the selection.
4. Press  several times to exit the menu.

Configure Control Source



Follow the steps below to configure the source to use for programming the voltage and current output.

Note: Voltage programming is on Pin 20 and current programming is on Pin 22 of the DB25 Analog interface.

1. From the **CONFIG** menu, browse and select **Ext-Ctrl** and press . The following screen will display:

Ext – Ctrl Setup

10v-M 10v/10k-P V-P Off





2. Select the second item **10v/10k-P** or **5v/5k-P** so that it is blinking. Use the \blacktriangle \blacktriangledown keys to change between **10v/10k-P** and **5v/5k-P**.
5v/5k-P – 0 – 5 V (for voltage) or 0 – 5 k Ω (for resistance) is used for programming the voltage and current output.
10v/10k-P – 0 – 10 V (for voltage) or 0 – 10 k Ω (for resistance) is used for programming the voltage and current output.
3. Press  when finished making the selection.
4. Press  several times to exit the menu.

Select Source Type

For external voltage and current programming of the output, users can configure the power supply to be controlled with external DC voltages or resistances. Follow the instructions below to select the source type.

1. From the **CONFIG** menu, browse and select **Ext-Ctrl** and press . The following screen will display:





2. Select the third item **V-P** or **R-P** so that it is blinking. Use the   keys to change between **V-P** or **R-P**.
V-P – Use external DC voltage source for programming the output.
R-P – Use external resistance for programming the output.
3. Press  when finished making the selection.
4. Press  several times to exit the menu.

Enable/Disable External Analog Control

If external analog control is not used, it must be disabled before normal front panel operation can resume. Follow the steps below to enable or disable external analog control.

1. From the **CONFIG** menu, browse and select **Ext-Ctrl** and press . The following screen will display:



2. Select **Off** and press . This will **disable** external analog control. To **enable**, select **Off** and press the down arrow key to select **On**. Press  after selection.
3. When finished, press  several times to exit the menu.

Pin Assignment

Below are the pin assignments of the analog interface.

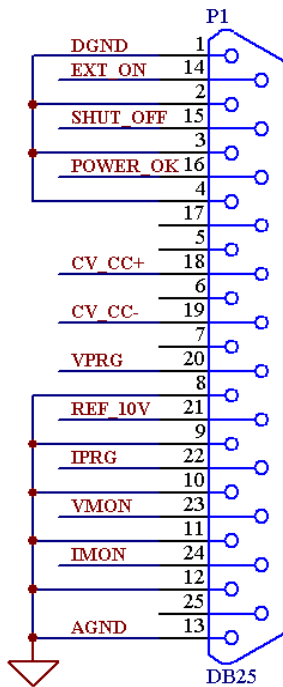

Figure 3.3 - Analog Interface Pin Assignments

Pin #	Label	Description
1	DGND	Ground pin
14	EXT_ON	Control output state
15	SHUT_OFF	Emergency shut off
16	POWER_OK	Status output
18	CV_CC+	CV mode status
19	CV_CC-	CC mode status
20	VPRG	Voltage programming input
21	REF_10V	10V DC reference output
22	IPRG	Current programming input
23	VMON	Voltage monitoring output
24	IMON	Current monitoring output
13	AGND	Ground pin

CAUTION

DO NOT input any voltages above 10 V DC or 10 k Ω resistance or below 0 V DC to any of the 25 pins. Doing so will damage the power supply. The inputs also do not have reverse polarity protection. Check your positive and negative connections carefully first before feeding power into the control pins.

Control Output State

The output state of the power supply can be controlled by EXT_ON (pin 14) and DGND (pin 1).

Output ON State - Pin 14 and Pin 1 are connected/shorted together.

Output OFF State - Pin 14 and Pin 1 are opened and not connected together.

Emergency Shut Off

In the case where an emergency shut off to the output of the power supply is required, **SHUT_OFF (pin 15)** and **DGND (pin 1)** is used.

To shut off, connect/short **Pin 15** and **Pin 1** together. This will bypass the analog control of the output state and disable (OFF) the output. In this case, **pin 14** and **pin 1** will need to be disconnected/opened from each other and reconnected to enable output again.

Power Supply Status

The power supply status can be monitored using **POWER_OK (pin 16)** output and **DGND (pin 1)**.

During normal operating conditions, this pin will output **5 VDC**. If OTP condition or other abnormalities occur, this pin will output **0 VDC**.

Monitoring Operation Mode

The operation mode of the power supply can be monitored using **CV_CC+ (pin 18)** and **CV_CC- (pin 19)** output pins.

CV Mode – **Pin 18** and **Pin 19** will output 5 V DC.

CC Mode – **Pin 18** and **Pin 19** will output –5 V DC.

OFF – **Pin 18** and **Pin 19** will output 0 VDC.

Control Output Settings

The voltage and current output settings can be configured using an external source connected to **VPRG (pin 20)** and **Ground (pin 8)** for voltage and **IPRG (pin 22)** and **Ground (pin 10)** for current.

Follow the instructions in the previous sections for configuration and setup.

Monitor Output Settings

The voltage and current output can be monitored using **VMON (pin 23)** and **Ground (pin 11)** for voltage and **IMON (pin 24)** and **Ground (pin 12)** for current.

Follow the instructions in the previous sections for configuration of the voltage scale to use for monitoring. The scale can be selected between **0 – 10 VDC** or **0 – 5 VDC** to reflect 0 – 100% of voltage or current output.

Reference Voltage

A 10 VDC reference output is available on REF_10V (pin 21) and Ground (pin 9).

Note: These pins are used for reference only and are not designed to power devices. Do not connect a load across it.

Configure Voltage Limit

The minimum and maximum set voltage can be configured on the power supply to limit the settable voltage range for protection.



Note: At any time during operation, when you are unable to set to a desired voltage, check this voltage limit setting to make sure the set value is within range.

Follow the steps below to configure the voltage limits:

1. From the **CONFIG** menu, browse and select **Limit** and press . The following screen will display:

Voltage Range

Vmin = 0.000 V

2. With **Vmin** prompted, use the voltage or current adjust knob or the numeric keypad to enter the minimum voltage limit value.
3. When finished, press , and the display will prompt with **Vmax**.
4. Enter the maximum voltage limit value the same way as in step 2.
5. When finished, press . The screen will return to the **CONFIG** menu.
6. Press  several times to exit the menu.

Parallel/Series Connection

More than one unit of the **same model** can be connected in a parallel or series configuration. Table 3.2 below shows the total number of units that can be connected in each configuration. The power supplies can be set up in master/slave mode so that the master unit can control all other power supplies in the parallel or series connection.

Note: Master/slave configurations and RS-485 connections must be properly set up prior to controlling the power supplies in parallel/series connection. However, RS-485 does not have to be set as the Communication interface for master/slave operation to function.

Table 3.2 – Series/Parallel Configuration Table

Model	Series	Parallel
9115 and 9115-AT	3 units (240 V Max)	3 units (180 A Max)
9116	2 units (300 V Max)	4 units (120 A Max)
9117	3 units (240 V Max)	4 units (480 A Max)

⚠ WARNING

Connecting more units in series/parallel than specified in the table above can cause damage to the power supplies and void the manufacturer's warranty.

Connection and Setup

Connecting multiple power supplies in parallel or in series can increase the overall current output or voltage output respectively. For this configuration to function properly, there are several items that must be set up first. Follow the instructions in this section carefully for setup.

Connection

Determine the total number of power supplies that you want to connect in parallel or series. Disable the output of the power supplies and power OFF the power supplies.

⚠ WARNING

For safety, always turn OFF the power supplies before connecting or disconnecting wires to the output terminal.

For parallel connection:

Connect each power supplies' positive (+) terminals together. Do the same for the negative (-) terminals.

For series connection:

Connect one power supply's positive (+) terminal to the negative (-) terminal of another. Do the same for all the power supplies.

Then, connect all of the power supplies' **Pin 1** of the RS-485 interface together. Do the same for **Pin 5**.

Below illustrates the connection diagram for parallel connection.

Note: Be sure to use wires that can support the amount of output current that you want to output from the power supplies. Refer to "2.2 Output Connections" for details.

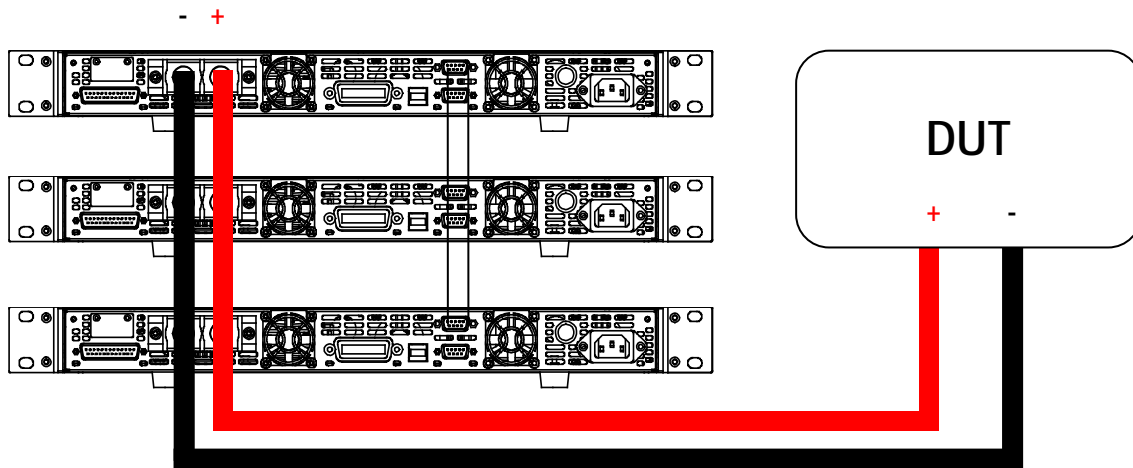

Figure 3.4 – Master/Slave Parallel Connection Diagram

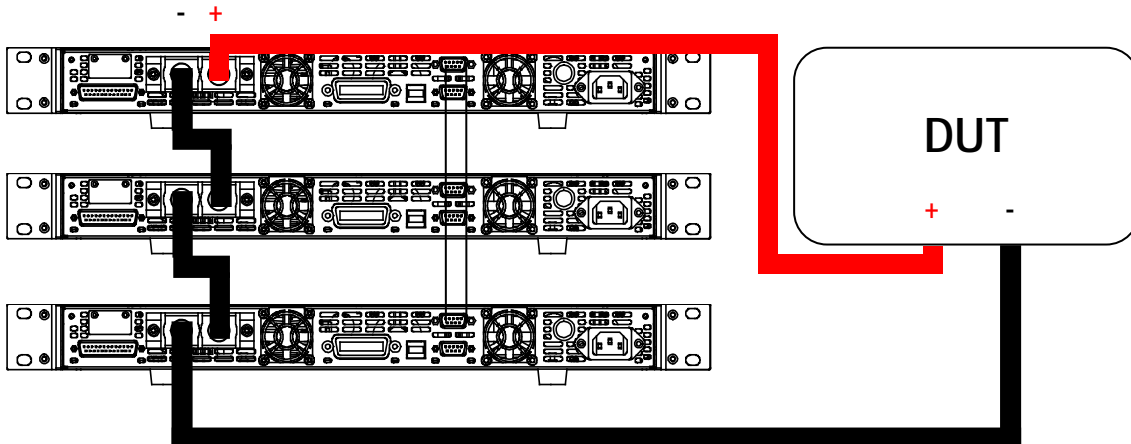

Figure 3.5 - Master/Slave Series Connection Diagram

Master/Slave Setup

Only one power supply has to be configured as a **Master**. The rest must be configured as **Slave**. Up to 3 units can be configured in total.

Note: Configure Slave power supplies FIRST, and configure the Master power supply LAST. For remote or front panel operation, only control the Master power supply.

Master/Slave Configuration







After physically connecting the power supplies for parallel or series operation, power ON the power supplies and follow the steps below to configure a power supply as a **master** or **slave**.

1. From the **CONFIG** menu, select **Online** and press  **Enter**. The following will display:

Online Setup

Parallel Slave Addr... Off

2. While **Parallel** or **Series** is flashing, use   keys to toggle between the two options. Set to **Parallel** for parallel connection and **Series** for series connection.

3. Press the  key to select **Slave** or **Master**. Use the   keys to select between the two options. Select **Master** to set the power supply as a **master**, or select **Slave** to set the power supply as a **slave**. Always set the **Slave** supplies first and **Master** supply last.
4. Press the  key to select **Addr....** Press  and the display will prompt to enter an address. Use the numeric keypad to enter an **Address**, which must be different than all other power supplies that you want to connect together in parallel. Enter any number between 0 – 31.
5. Press  to save the changes.
6. Exit the menu by pressing  several times.

3.5 Program Sequence Mode (List mode)

Note: Internal List mode functionality is not available on model 9117
List mode functionality is only available in the software program for model 9117.

The power supply (models 9115(-AT) and 9116 only) has a list mode feature that allows storing programmed sequences into internal non-volatile memory and recalling and running them per configured parameters. A total of 10 steps can be configured for each sequence, and a total of 10 sequences are available for storage. Additionally, multiple sequences or all 10 sequences can be saved into a program configuration, where each program configuration allows running one sequence after another. This allows for a total maximum of 100 steps in one program configuration. Up to 10 program configurations can be saved and recalled to and from the non-volatile memory. Below is an illustration of how programmed sequences are structured, stored, and recalled.

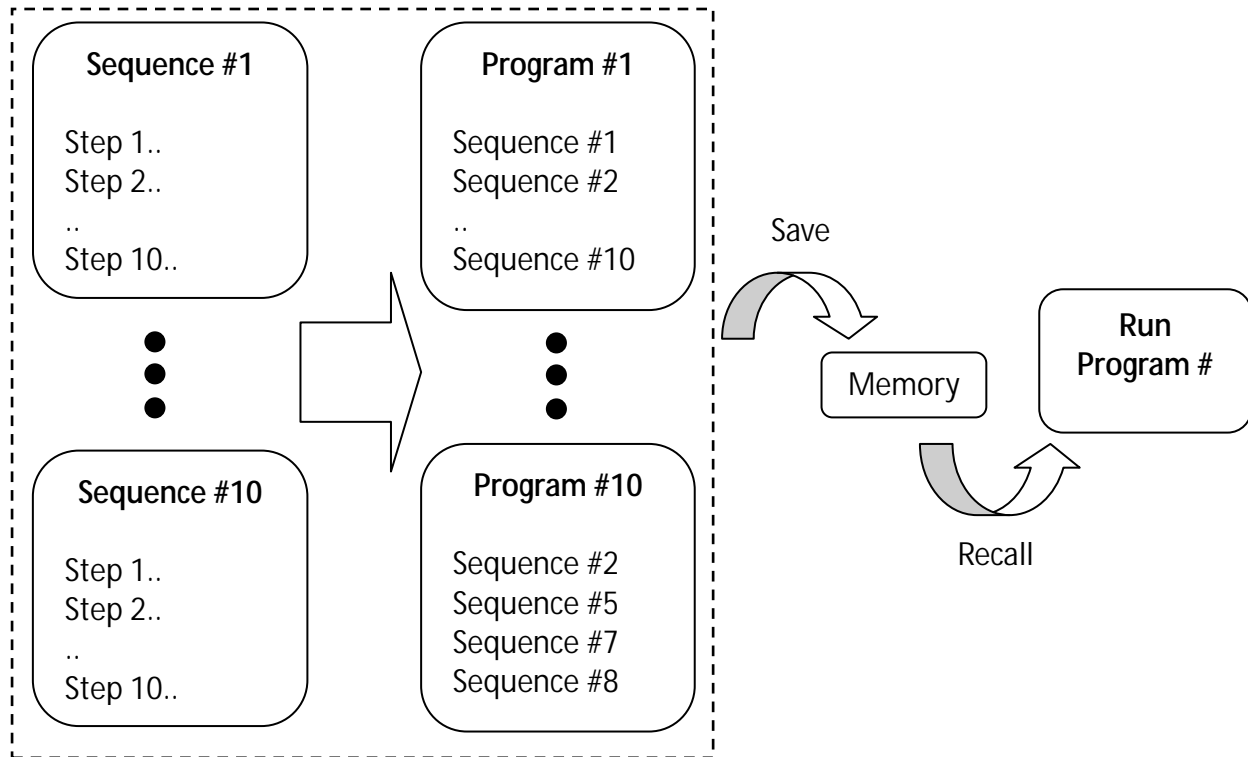

Figure 3.6 – List Mode Illustration

There are three separate configurations to set up for programming and running a sequence (in order):

1. Configure Sequence Parameters
2. Configure Program (List)
3. Recall and Run Program

Note: These configurations must be set up in order.

The following sections will go into the details of setting up all three configurations.

Note: It is recommended that the Trigger Source be configured prior to setting up the configurations. Additionally, the output of the power supply must be disabled prior to setting up the configurations.

Configure Sequence Parameters

Each sequence can store from 1 to 10 steps. Each step's parameters contain voltage setting, current setting, width (time to hold the step), and slope (voltage rise and fall). The adjustable range for each of these parameters are specified in table below:

Table 3.3 - Step Parameter Range

Parameter	Adjustable Range
Voltage Setting	0.000 – < OVP Voltage
Current Setting	0.000 – *max. current setting
Width	0.001 seconds – 86400 seconds
Slope	0.002 seconds – 86400 seconds

*Maximum current and voltage setting cannot exceed maximum power configured under P-max setting.

As an example, follow the steps below to set up a sequence with fixed current limit of 1 A, as illustrated below:

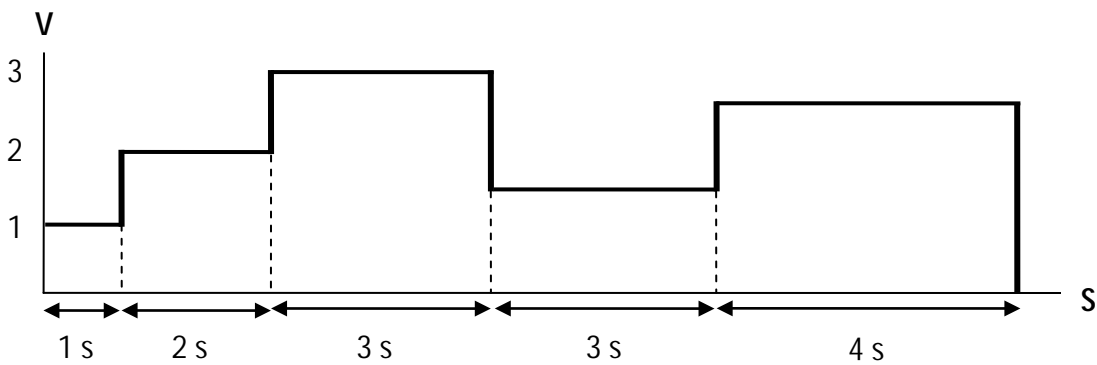

Figure 3.7 - Program Sequence Example

1. Access the main menu by pressing **Shift** and the **Menu** **OVP**.
2. Use the **▶** key to select **LIST (FUNC.** then press **Trigger** **Enter** twice for model 9115-AT) and press **Trigger** **Enter**. The below screen will display:



3. Use the **▶** key to select **EditSeq** and press **Trigger** **Enter**. The display will say **EDIT SEQ** and an entry for **Seq Name:** is displayed.
4. Use the current adjust knob or the numeric keypad to select any number between 1 – 10 to edit its sequence. Press **Trigger** **Enter**. Now, the following screen will display:

SEQ

Active Step: 0987654321

5. These numbers represent the step numbers of the sequence, where "0" represents step number 10. At this point, use the numeric keypad and try to push any numbers 0 – 9. Notice that the number you press will correspond to the number displayed in **Active Step** and will toggle to display a "Y" in its place.
6. The "Y" represents a selection of the step number, making it an active step (meaning the step is enabled in the sequence). For the steps you want to configure as active, use the numeric keypad to select so that the corresponding number changes to "Y". Pressing the same number will change the "Y" back to the corresponding number. For example, if you want to configure and store a sequence with steps 1, 4, 6, and 8, press 1, 4, 6, and 8 on the numeric keypad so that the following will display:

SEQ

Active Step: 09Y7Y5Y32Y

7. For this example, steps 1, 2, 3, 4, and 5 will be used, so use the numeric keypad and press 1, 2, 3, 4, and 5 until it displays:

SEQ

Active Step: 09876YYYYY

8. Once set, press . The display will change to the following:

EDIT SEQ VOLTAGE

Seq Step 1 Voltage = 1.000V

9. This is prompting the user to enter the voltage setting for **step 1**. Use the voltage and current adjust knob or the numeric keypad and enter **1.000**. Then press .
10. The display will change to the following, prompting the user to enter the current setting for step 1.

EDIT SEQ CURRENT

Seq Step 1 Current = 1.000A

11. Similar to entering the voltage setting in the previous step, do the same to enter **1.000** as the current setting. Then press . Now, the following will display:



EDIT SEQ WIDTH

Seq Step 1 Width = 1.000s

12. Enter the width, which is the time to hold the voltage and current setting configured in the previous steps. Enter **1.000** (for 1 second). Press . Now, the following will display:

EDIT SEQ SLOPE

Seq Step 1 Slope = 0.005s

13. Enter the slope, which defines the voltage slew rate (transition time between steps) for **step 1**. Enter **0.005**. Press .
14. Now, the display will return back to the display shown in step number 8, except it will prompt the user to enter the voltage setting for **step 2** of the sequence. Follow steps 8-13 to configure step 2 with: 2V, 1A, 2s width, 0.005s slope. Then step 3 with: 3V, 1A, 3s width, 0.005s slope. Then step 4 with: 1.5V, 1A, 3s width, 0.005s slope. Finally, step 5 with: 2.5V, 1A, 4s width, 0.005s.
15. After **step 5** parameters are configured, the display will show the following to request confirmation to save the step parameters into memory. Press  key to select **Yes** and press .

SAVE SEQ

No Yes

16. If stored successfully, the display will show a message **Save Success!** After a few seconds, it will return to the **LIST** menu.

Configure Program (List)

The sequence(s) to execute and run can be selected, as well as its repetitiveness. This means multiple sequences can be run one after another. With 10 steps per sequence and up to 10 sequences configured, a program can run with a maximum of 100 steps.

As an example, take the sequence illustrated in the previous section as sequence #1, and sequence #2 to run after sequence #1. Suppose sequence #2 is already stored into memory and is illustrated as the following:

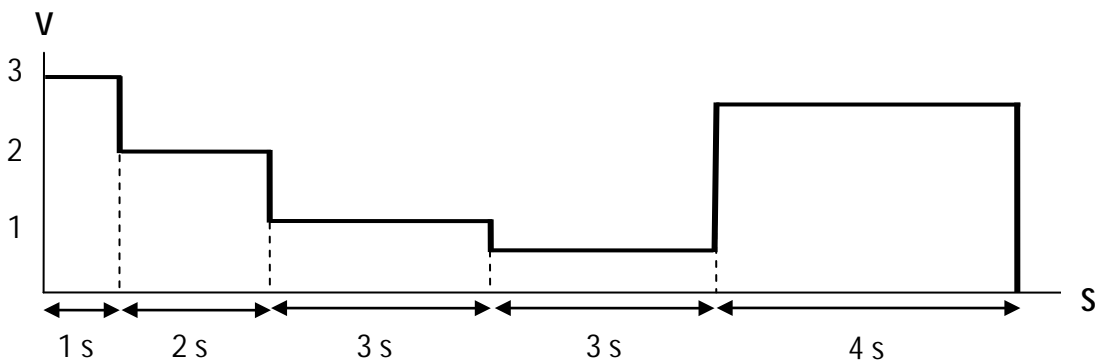

This example setup will run sequence #1 two times and sequence #2 three times, then repeat five times. Follow the steps below to configure this:

1. From the **LIST** menu, use the key to select **EditList** and press . The display will say **EDIT LIST FILE** with the prompt **File Name:** to ask to enter a file name number.
2. Use the current adjust knob or the numeric keypad to select any number between 1 – 10. This will be the location to store the program configurations. Press . Now, the following screen will display:

EDIT LIST POWER

List Power = 1200.0W

- This parameter is configured to limit the maximum power of the program (list) when it is executed. Leave it default to 1200.0 for maximum power output. Press  and the following will display:

EDIT LIST REPEAT

List Repeat = 1

- The display prompts the user to enter the number of times to repeat the program (list). For this example, enter 5 with the numeric keypad and then press .

Note: The maximum number of repeat times is 65535 times.

- The next display will show the following:

FILE

Active Seq: 0987654321

- This is similar to step 5 and 6 in the previous section for **Configure Sequence Parameters**. Each of the numbers on the display represents the sequence numbers stored in memory, with "0" representing sequence # 10.
- In this example, only sequence #1 and sequence #2 will be executed. Therefore, use the numeric keypad and press 1 and 2 so that both of those numbers on the display will toggle to "Y" in their places like the following:



FILE

Active Seq: 09876543YY

8. Once these two sequences are selected (active), press  to see the following:



SEQ REPEAT

Seq 1 Repeat: 1

9. The display prompts the user to enter the number of times to repeat sequence #1 as part of the program (list). In this example, use the current adjust knob or the numeric keypad to enter 2. Press  and the same prompt will immediately follow for sequence #2. Enter 3 and then press .
10. Now it will display the following to confirm saving the program (list).

SAVE LIST

No Yes



11. Press  key to select **Yes** and press  to save the program (list) into memory.
12. If stored successfully, the display will show a message **Save Success!** After a few seconds, it will return to the **LIST** menu.

Recall and Run Program

Once the sequence(s) and program are configured and stored into memory, they can be recalled and triggered to run.

Recall Program



Follow the steps below to recall a stored program from memory:

1. From the **LIST** menu, use the  key to select **Recall** and press . The display will say **RECALL LIST** with the prompt **Recall List File:** to ask to enter a number.
2. This is the location number where the program is stored in. Select a number between 1 to 10 with the current adjust knob or the numeric keypad, then press .
3. The display will return back to the **LIST** menu.







Run Program

To run a program sequence after it is recalled, the trigger source must be configured **first**. Refer to “Configure Trigger Source” in section 3.3 to set up the trigger source.

Follow the steps below to run the program:

1. Assuming the stored program has already been recalled, from the **LIST** menu, with **Off** selected, press . The **Trig** indicator will appear at the top middle of the display.
2. Now, press  twice to exit the menu. The following will display:



3. If the display is showing the measured voltage and current value, the  backlight should be lit and display should show **0.000V** and **0.000A**.
4. Now, press the  key to enable (ON) the output.
5. If the **Trigger Source** configured in section 3.3 is set to **Manual (Def)**, then the front panel trigger key can be used to initiate the program. Press  and then .
6. The program will immediately start running and the backlight of the  button will be blinking. The **Trig** indicator will also disappear.
7. When the program ends, the  will stop blinking and the **Trig** indicator will reappear again.

Note: If the Trigger Source is configured to BUS, use the remote command for sending triggers over any of the remote interface available. Refer to the programming manual for details.

3.6 9115-AT Automotive Test Functions

Note: This functionality is only available on model 9115-AT

The 9115-AT power supply has a unique automotive testing feature built-in that allows the user to run stress tests based on the DIN 40839 and ISO 16750-2 standards. The functions have the ability to test 12 volt and 24 volt systems. For details on the DIN 40839 and ISO 16750-2 standards, please see www.din.de (DIN standards) and www.iso.org (ISO standards).

DIN 40839 Parameters

The DIN40839 function simulates a test pulse based on the DIN 40839 standard. The standard pulse shape and parameters are shown below:

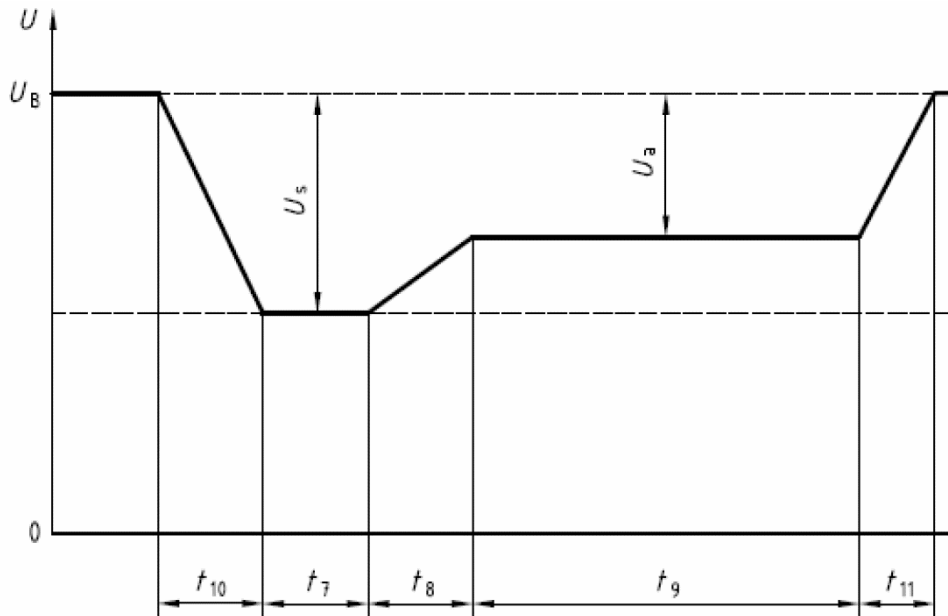

Figure 3.8 – Test Pulse waveform (DIN 40839)

Parameter	12 V system	24 V system
U_s	-6 V to -7 V	-6 V to -7 V
U_a	-2.5 V to -6 V with $ U_a \leq U_s $	-5 V to -12 V with $ U_a \leq U_s $
R_i	0 Ω to 0.02 Ω	
t_7	15 ms to 40 ms ^a	50 ms to 100 ms ^a
t_8	≤ 50 ms	
t_9	0.5 s to 20 s ^a	
t_{10}	5 ms	10 ms
t_{11}	5 ms to 100 ms ^b	10 ms to 100 ms ^c

^a The value used should be agreed between the vehicle manufacturer and the equipment supplier to suit the proposed application
^b $t_{11} = 5$ ms is typical of the case when engine starts at the end of the cranking period while $t_{11} = 100$ ms is typical of the case when the engine does not start.
^c $t_{11} = 10$ ms is typical of the case when engine starts at the end of the cranking period while $t_{11} = 100$ ms is typical of the case when the engine does not start.

Table 3.4 – Parameters for test pulse

Follow the steps below to set up the DIN40839 function:

1. Access the main menu by pressing **Shift** and the **Menu** **OVP**.
2. Use the **▶** key to select **FUNC.** and press **Enter**.
3. Use the **▶** key to select **DIN40839** and press **Enter**. The screen below will display:



4. While **12V** or **24V** is flashing, use **▲▼** keys to toggle between the two options. Set to **12V** for the 12V test function and **24V** for the 24V test function.
5. Use the **▶** key to select **Off/On** and use **▲▼** keys to toggle between the two options. Choose **On** to be able to run the function.
6. Once both parameters are set, press **Enter** to confirm the changed settings and press **Esc** twice to exit the menu. If the DIN40839 function was setup properly, the **Trig** indicator will be highlighted and **DIN40839** will be shown on the front panel, shown below.

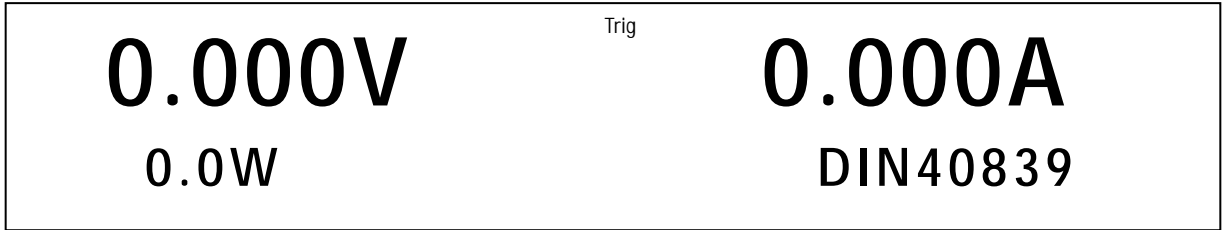

7. To enable the DIN40839 function, press the  key, on the front panel. The proper voltage (12V or 24V) should be metered on the front panel display.
8. To run the DIN40839 function press shift and enter to trigger the test to run.
9. Repeat step 8 to trigger the function to run as many times as needed.

ISO 16750-2 Parameters

The ISO16750-2 function contains three different test simulations, Short voltage drop, Profile for the reset test, and Starting profile. All three test simulations are based on the ISO 16750-2 requirements and applies to electric and electronic systems/components for vehicles. The pulse shapes and parameters are shown below:

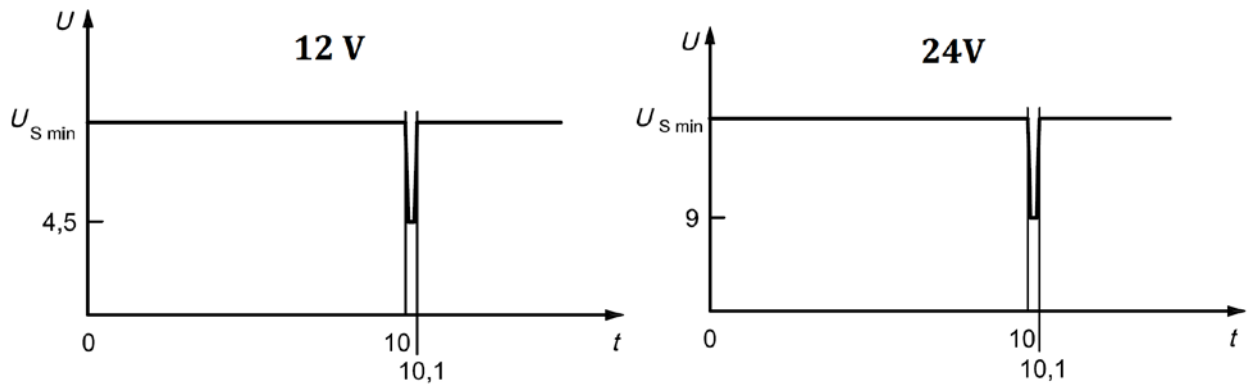

Figure 3.9 – Short voltage drop waveform

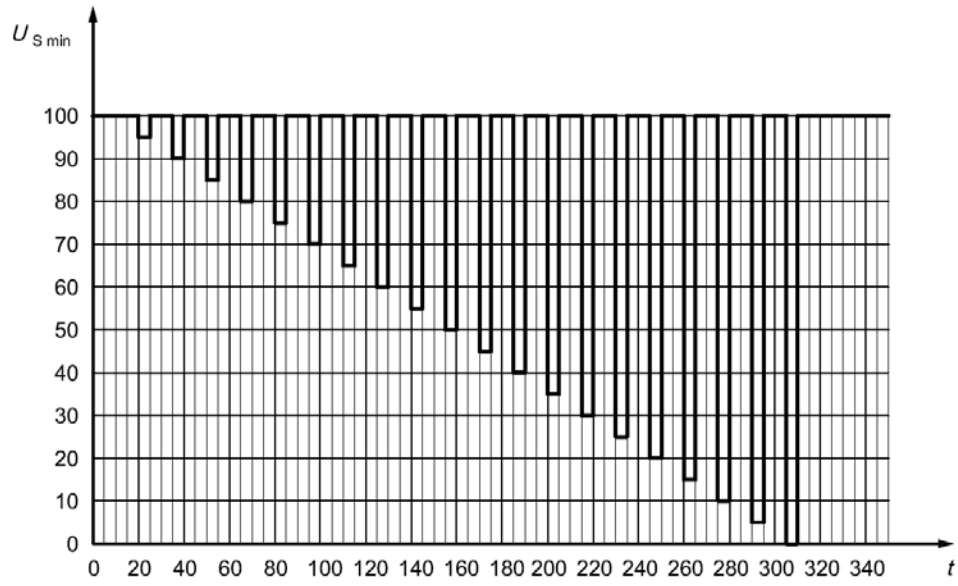

Figure 3.10 – Profile for the reset test waveform

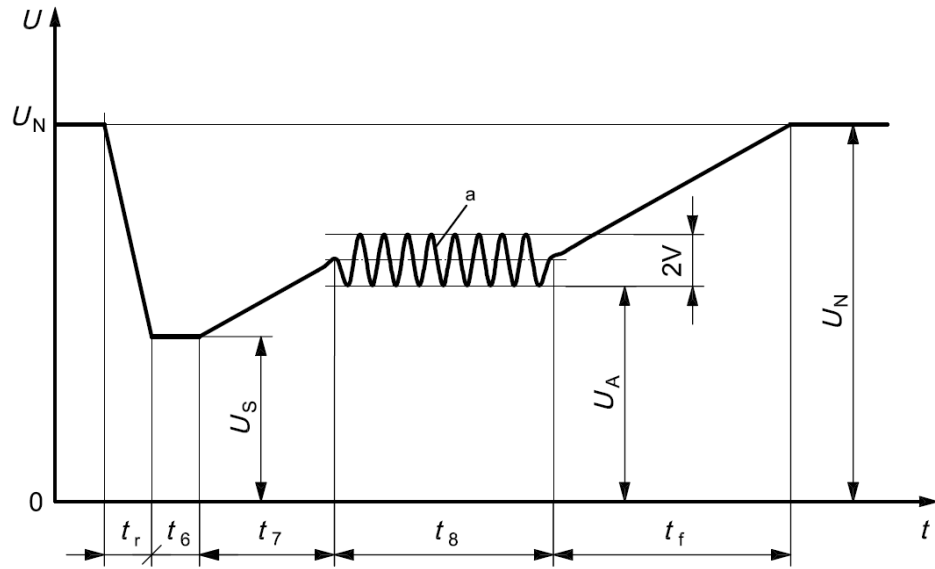

Figure 3.11 – Starting profile waveform

Code	Supply voltage V $U_{S\ min}$ $U_{S\ max}$		Levels/voltages/duration of starting profile				
			I	II	III	IV	Tolerances
			$U_S = 8\ V$	$U_S = 4,5\ V$	$U_S = 3\ V$	$U_S = 6\ V$	+ 0,2 V
			$U_A = 9,5\ V$	$U_A = 6,5\ V$	$U_A = 5\ V$	$U_A = 6,5\ V$	
			$t_r = 5\ ms$				± 10 %
			$t_6 = 15\ ms$				
$t_7 = 50\ ms$							
$t_8 = 1\ s$				—			
$t_f = 40\ ms$							
$t_8 = 10\ s$				—			
$t_f = 100\ ms$							
$t_8 = 1\ s$				—			
$t_f = 100\ ms$							
$t_8 = 10\ s$				—			
$t_f = 100\ ms$							
Functional status							
A	6	16	A	B	B	A	
B	8	16	A	B	C	B	
C	9	16	B	C	C	C	
D	10,5	16	B	C	C	C	

Table 3.5 – Starting profile values for 12 V system devices

Code	Supply voltage V $U_{S\ min}$ $U_{S\ max}$		Levels/voltages/duration of starting profile			
			I	II	III	Tolerances
			$U_S = 10\ V$	$U_S = 8\ V$	$U_S = 6\ V$	+ 0,2 V
			$U_A = 20\ V$	$U_A = 15\ V$	$U_A = 10\ V$	
			$t_r = 10\ ms$			± 10 %
			$t_6 = 50\ ms$			
$t_7 = 50\ ms$						
$t_8 = 1\ s$			—			
$t_f = 40\ ms$						
$t_8 = 10\ s$			—			
$t_f = 100\ ms$						
$t_8 = 1\ s$			—			
$t_f = 40\ ms$						
$t_8 = 10\ s$			—			
$t_f = 100\ ms$						
Functional status						
E	10	32	A	B	B	
F	16	32	B	C	C	
G	22	32	B	C	C	

Table 3.6 – Starting profile values for 24 V system devices







Short voltage drop

Follow the steps below to set up the ISO16750-2 for Short voltage drop function:



1. Access the main menu by pressing **Shift** and the **Menu** **OVP**.
2. Use the **▶** key to select **FUNC.** and press **Enter**.
3. Use the **▶** key to select **ISO16750-2** and press **Enter**. The screen below will display:

ISO16750-2 profile

Short voltage drop









4. While **Short voltage drop** is flashing, press  to access that option. Set to **12V** for the 12V test function and **24V** for the 24V test function.
5. Use the  key to select **Off/On** and use   keys to toggle between the two options. Choose **On** to be able to run the function.
6. Once both parameters are set, press  to confirm the changed settings and press  several times to exit the menu. If the Short voltage drop function was setup properly, the Trig indicator will be highlighted and **Short voltage drop** will be shown on the front panel, shown below.



7. To enable the Short voltage drop function, press the  key, on the front panel. The proper voltage (12V or 24V) should be metered on the front panel display.
8. To run Short voltage drop function press  and  to trigger the test to run.
9. Repeat step 8 to trigger the function to run as many times as needed.







Profile for reset

Follow the steps below to set up the ISO16750-2 Profile for the reset test function:



1. Access the main menu by pressing  and the .
2. Use the  key to select **FUNC.** and press .
3. Use the  key to select **ISO16750-2** and press .
4. While **Short voltage drop** is flashing, use   keys to toggle to **Profile for the reset test** (shown below) and press  to access that option.

ISO16750-2 profile

Profile for the reset test

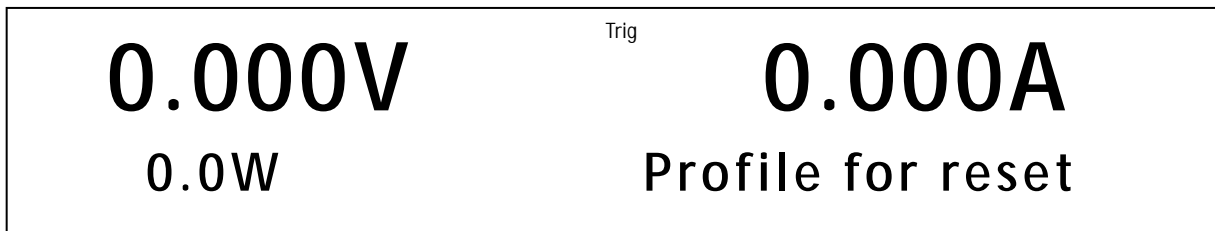
5. Select **Usmin...** and press enter. The user can choose a Usmin value between 1 V – 80 V. Once a value is selected, press  to confirm.
6. Use the  key to select **Off/On** and use   keys to toggle between the two options. Choose **On** to be able to run the function.
7. Once both parameters are set, press  to confirm the changed settings and press  several times to exit the menu. If the Starting profile function was setup properly, the **Trig** indicator will be highlighted and **Profile for the reset test** will be shown on the front panel, shown below.











8. To enable the Profile reset test function, press the  key, on the front panel. The proper voltage selected should be metered on the front panel display.
9. To run the Profile reset test function press  and  to trigger the test to run. Please be aware this test does run for 340 seconds (See profile reset test figure above).

Starting profile















There are different profiles available for 12 V systems and 24 V systems, please refer to the tables above to configure the power supply options properly.

Follow the steps below to set up the ISO16750-2 for Starting profile function:

1. Access the main menu by pressing  and the .
2. Use the  key to select **FUNC.** and press .
3. Use the  key to select **ISO16750-2** and press .
4. While **Short voltage drop** is flashing, use   keys to toggle to **Starting profile** (shown below) and press  to access that option.

ISO16750-2 profile



Starting profile



5. Set to **12V** for the 12V test system and **24V** for the 24V test system.
6. Use the  key to select the profile of **1 / 2 / 3 / 4**(12 V only) and use   keys to toggle between the four options.
7. Use the  key to select **Repeat** and press . This option allows the user to repeat the profile up to 100 times. Once a value is selected, press  to confirm.
8. Use the  key to select **Delay** and press . This option allows the user to delay the repeated profile up to 100 seconds. Once a value is selected, press  to confirm.
9. Use the  key to select **Off/On** and use   keys to toggle between the two options. Choose **On** to be able to run the function.
10. Once both parameters are set, press  to confirm the changed settings and press  several times to exit the menu. If the Starting profile function was setup properly, the **Trig** indicator will be highlighted and **Starting profile** will be shown on the front panel, shown below.

0.000V
0.0W

Trig

0.000A
Starting profile

11. To enable the Short voltage drop function, press the  key, on the front panel. The proper voltage (12V or 24V) should be metered on the front panel display.
12. To run the Starting profile function press  and  to trigger the test to run.
13. Repeat step 8 to trigger the function to run as many times as needed or setup the repeat functionality.

Note: If any automotive testing is running the  will blink to indicate so. To stop any test from running further, press  and .

3.7 Configure Voltage Slope

The power supply has the capability of controlling the slope of the output voltage during changes between voltage settings. Timings can be configured for both the rising and falling edge between voltage output transitions.

To illustrate this feature and provide configuration instructions, follow the example below.

Suppose you want to simulate the voltage signal below by manually setting the voltage from 5 V to 10 V over a span of 5 seconds, then manually changing it to 1 V and have it decrease from 10 V to 1 V over a span of 10 seconds. This can be done by configuring the rising and falling edge timing.

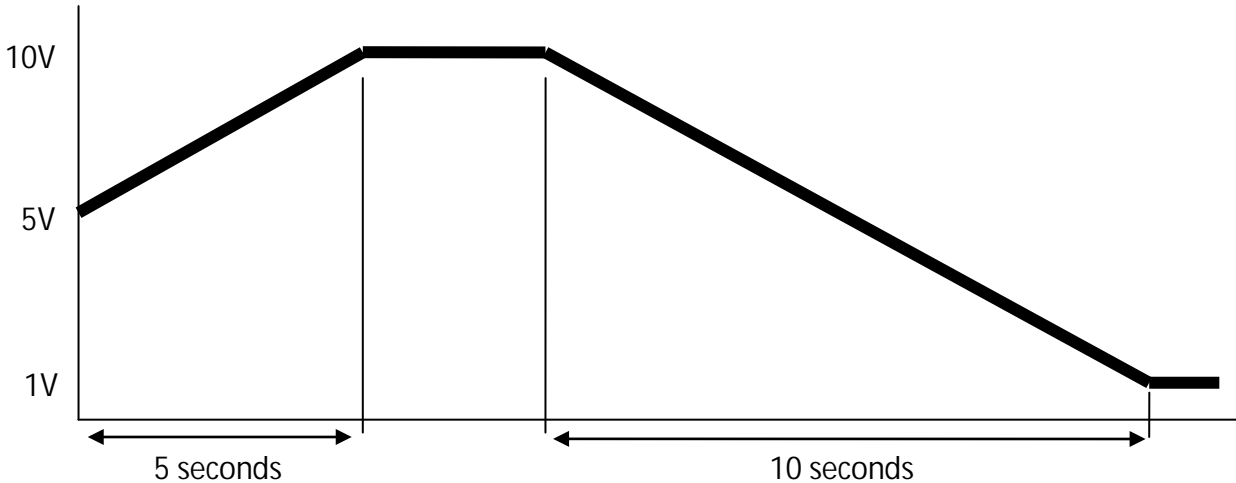







Figure 3.12 – Voltage Slope Waveform Example

Follow the steps below to configure the voltage slope to simulate the voltage output signal above.







1. Press **Shift** and **Slope V-set**. The screen below will be displayed.



2. T_{rise} is the rising edge time for an output voltage transition. Use the numeric keypad or the current adjust knob and enter **5.000 s (5 seconds)**.
3. Press  and T_{fall} will be displayed. T_{fall} is the falling edge time for an output voltage transition.
4. Use the numeric keypad or the current adjust knob and enter **10.000 s (10 seconds)**.
5. Press  and the power supply will return to the normal display.
6. Now, set voltage to 5 V using the numeric keypad or the voltage adjust knob. Then, turn ON the output by pressing .
7. At this point, the output voltage should be 5V. Push the  button until it is lit up, thus showing the measured voltage and current display.
8. Now, set voltage to 10 V using the numeric keypad, then press . Observe that the supply will slowly ramp its voltage output to 10 V over a span of 5 seconds.
9. When the supply has reached 10 V, use the numeric keypad and enter 1 V. Press  and observe the output voltage slowly ramping down to 1 V over a span of 10 seconds.

3.8 Key Lock

The front panel keys can be locked to prevent unwanted changes to output settings and power supply configurations. Follow the steps below to enable/disable key lock.

1. Press  and . A * indicator will light up on the display, indicating that the front panel keys are lock. At this point, all keys are disabled except for  and  (Lock function only).
2. To unlock the keys again, press  and  again. The * indicator will disappear and all keys will be enabled.

4 Remote Operation

4.1 Interface Connection

RS-232

For RS-232 connectivity, refer to the diagram below for pinout information. The RS-232 is labeled in the rear panel and it is a female DB-9 interface.

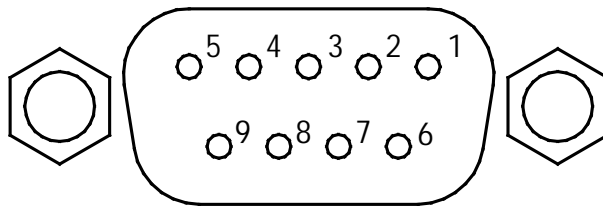

PIN	Description
1	-
2	Transmit Data
3	Receive Data
4	-
5	GND
6	-
7	-
8	-
9	-

A straight pin-to-pin DB9 female to DB9 male serial cable is required for using the RS-232 interface. Do not use a null modem or crossover DB9 serial cable.

GPIB

The power supply can be configured with a GPIB address from 0 – 31. To communicate via GPIB, connect a GPIB cable to the GPIB interface on the rear panel, as illustrated below.

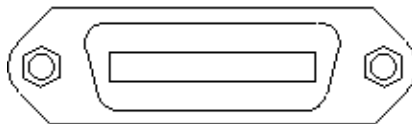

RS-485

For multi-unit configuration and control, the male DB-9 interface labeled RS-485 in the rear panel is used. The figure below illustrates the connection pins and description.

Note: Pin 1 is used as the A pin (-) (non-inverting).
Pin 5 is used as the B pin (+) (inverting).
SC (reference) pin is not used.

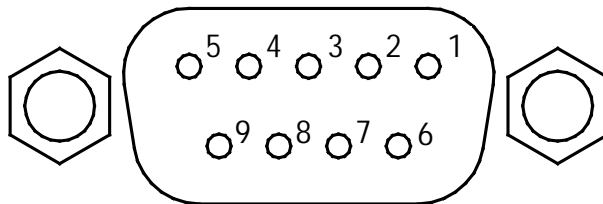

PIN	Description
1	A (-)
2	-
3	-
4	-
5	B (+)
6	-
7	-
8	-
9	-

USBTMC

The device is SR1, RL1, and DT1 enabled. It can receive the following request: REN_CONTROL, GO_TO_LOCAL, LOCAL_LOCKOUT. When it receives MsgID = TRIGGER USBTMC command, it will transmit TRIGGER command to the function layer.

Ethernet (LAN)

The power supply (Model 9117 only) can be connected via the Ethernet interface. To communicate, connect a standard RJ-45 cable to the Ethernet port on the rear panel of the power supply unit.



4.2 Remote Commands

The instrument supports some SCPI commands and some instrument specific commands. These commands enable a computer to remotely communicate and control the power supply over any of the supported remote interfaces: USBTMC, RS-232, GPIB, RS-485, and Ethernet (Model 9117 only).

Refer to the programming manual for details, which can be downloaded from www.bkprecision.com.

5 Troubleshooting Guide

Below are some frequently asked questions and answers. Please check if any apply to your power supply before contacting B&K Precision.

General

Q: I cannot power up the power supply.

- Check that the power cord is securely connected to the AC input and there is live power from your electrical AC outlet.
- Verify that the AC power coming from the mains have the correct voltage. The power supply can accept a specific range of AC input voltages. Refer to section "2.1".

Q: How do I set up the supply to run in constant current mode?

- The supply is a CV/CC power supply that automatically crosses over from CV to CC upon a load which draws current at the current limit (ISET). Therefore, it is dependent on the load. For example, if ISET is configured as 1 A, the load must draw 1 A before the supply will go into CC mode.

Q: How come my display voltage is lower than the voltage I set?

- This is often because of the resistances from the test leads/wires connected between the supply and the DUT (device under test), which causes a drop in voltage. To minimize this drop, use remote sense terminals to compensate and output a more accurate voltage to the DUT.

Q: I cannot set voltage at the maximum rating.

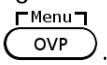
- This may be that the set voltage is outside of the voltage maximum limit. Refer to section 3.3 under "Configure Voltage Limit" to verify and configure the limits.
- Verify the over voltage protection setting by pressing .

Remote Control

Q: I am trying to send the commands over USB/RS232, but it does not seem to respond.

- Check that you are sending ASCII strings that are terminated with a CR (carriage return) and LF (linefeed) character.
- For RS-232 and RS-485, check that the baudrate, parity, data bits, stop bit, and flow control settings match with the settings configured on the software interface.
- For RS-485, check that the wires are correctly daisy chained between multiple units.

6 Specifications

Note: All specifications apply to the unit after a temperature stabilization time of 15 minutes over an ambient temperature range of 23 °C ± 5 °C. Specifications are subject to change without notice.

Environmental Conditions:

This power supply is designed for indoor use and operated with maximum relative humidity of 95%.

Model		9115 / 9115-AT	9116	9117
Output Rating	Voltage	0 – 80 V	0 – 150 V	0 – 80 V
	Current	0 – 60 A	0 – 30 A	0 – 120 A
Max Output Power		1200 W	1200 W	3000 W
Load Regulation ^{(1) (2)}	Voltage	0.01 % + 5 mV	0.05 % + 30 mV	0.05 % + 30 mV
	Current	0.1 % + 10 mA	0.1 % + 30 mA	0.1 % + 30 mA
Line Regulation ⁽²⁾	Voltage	0.02 % + 1 mV	0.02 % + 20 mV	0.02 % + 20 mV
	Current	0.02 % + 1 mA	0.02 % + 10 mA	0.02 % + 10 mA
Programming/Readback Resolution	Voltage	1 mV	3 mV	2 mV
	Current	1 mA	1 mA	3 mA
Programming/Readback Accuracy ⁽²⁾	Voltage	0.02 % + 30 mV	0.05 % + 30 mV	0.05 % + 30 mV
	Current	0.1 % + 60 mA	0.2 % + 30 mA	0.2 % + 120 mA
Ripple (20 Hz – 20 MHz)	Voltage	≤ 60 mVpp	≤ 60 mVpp	≤ 80 mVpp
	Current	100 mArms	40 mArms	120 mArms
Temperature Coefficient (0 °C – 40 °C) ⁽²⁾	Voltage	0.02 % + 30 mV		
	Current	0.05 % + 10 mA		
Readback Temperature Coefficient (0 °C – 40 °C) ⁽²⁾	Voltage	0.02 % + 30 mV		
	Current	0.05 % + 5 mA		
Efficiency		73% (120 VAC) 75% (220 VAC)	75% (120 VAC) 80% (220 VAC)	80% (220 VAC)
Power Factor (full load)		0.99	0.99	0.987
Input Current (nominal)		13.8 A @ 120 VAC 7.3 A @ 220 VAC	13.3A @ 120 VAC 6.9 A @ 220 VAC	17.1 A @ 220 VAC
AC Input		115/230 VAC ± 10 %, 47 Hz – 63 Hz	115/230 VAC ± 10 %, 47 Hz – 63 Hz	220 VAC ± 10 %, 47 Hz – 63 Hz
Standard Interface		USB/TMC, GPIB, RS-232, RS-485, Ethernet ⁽³⁾		
Dimensions (WxHxD) (mm)		414.5 x 44.5 x 483.2	414.5 x 44.5 x 483.2	436.5 x 89.3 x 532
Weight		8.5 kg	8.5 kg	17 kg
Operating Temperature		0 °C – 40 °C		
Storage Temperature		-20 °C – 70 °C		

⁽¹⁾ With remote sense connected

⁽²⁾ Accuracy specified as ±(% of output + offset) after a temperature stabilization time of 15 minutes over an ambient temperature range of 23 °C ± 5 °C

⁽³⁾ For model 9117 only

To ensure the most current version of this manual, please download the latest version here:

<http://www.bkprecision.com/search/9115>

For current up-to-date product information, please visit www.bkprecision.com

7 Calibration

We recommend a calibration interval of once per year to ensure that the power supply meets specifications.

The instrument features closed-case calibration, however it is performed remotely via the remote interface.

SERVICE INFORMATION

Warranty Service: Please go to the support and service section on our website at www.bkprecision.com to obtain a RMA #. Return the product in the original packaging with proof of purchase to the address below. Clearly state on the RMA the performance problem and return any leads, probes, connectors and accessories that you are using with the device.

Non-Warranty Service: Please go to the support and service section on our website at www.bkprecision.com to obtain a RMA #. Return the product in the original packaging to the address below. Clearly state on the RMA the performance problem and return any leads, probes, connectors and accessories that you are using with the device. Customers not on an open account must include payment in the form of a money order or credit card. For the most current repair charges please refer to the service and support section on our website.

Return all merchandise to B&K Precision Corp. with prepaid shipping. The flat-rate repair charge for Non-Warranty Service does not include return shipping. Return shipping to locations in North America is included for Warranty Service. For overnight shipments and non-North American shipping fees please contact B&K Precision Corp.

B&K Precision Corp.
22820 Savi Ranch Parkway
Yorba Linda, CA 92887
www.bkprecision.com
714-921-9095

Include with the returned instrument your complete return shipping address, contact name, phone number and description of problem.

LIMITED ONE-YEAR WARRANTY

B&K Precision Corp. warrants to the original purchaser that its products and the component parts thereof, will be free from defects in workmanship and materials for a period of **one year** from date of purchase.

B&K Precision Corp. will, without charge, repair or replace, at its option, defective product or component parts. Returned product must be accompanied by proof of the purchase date in the form of a sales receipt.

To help us better serve you, please complete the warranty registration for your new instrument via our website www.bkprecision.com

Exclusions: This warranty does not apply in the event of misuse or abuse of the product or as a result of unauthorized alterations or repairs. The warranty is void if the serial number is altered, defaced or removed.

B&K Precision Corp. shall not be liable for any consequential damages, including without limitation damages resulting from loss of use. Some states do not allow limitations of incidental or consequential damages. So the above limitation or exclusion may not apply to you.

This warranty gives you specific rights and you may have other rights, which vary from state-to-state.

B&K Precision Corp.
22820 Savi Ranch Parkway
Yorba Linda, CA 92887
www.bkprecision.com
714-921-9095



22820 Savi Ranch Parkway
Yorba Linda, CA 92887
www.bkprecision.com

© 2014, 2015 B&K Precision Corp.