

THIS DOCUMENT IS THE PROPERTY OF
KEYSTONE ELECTRONICS CORP. AND
SHALL NOT BE REPRODUCED, DISTRIBUTED
OR USED AS A BASIS FOR MANUFACTURE
WITHOUT PRIOR WRITTEN PERMISSION
FROM KEYSTONE ELECTRONICS CORP.

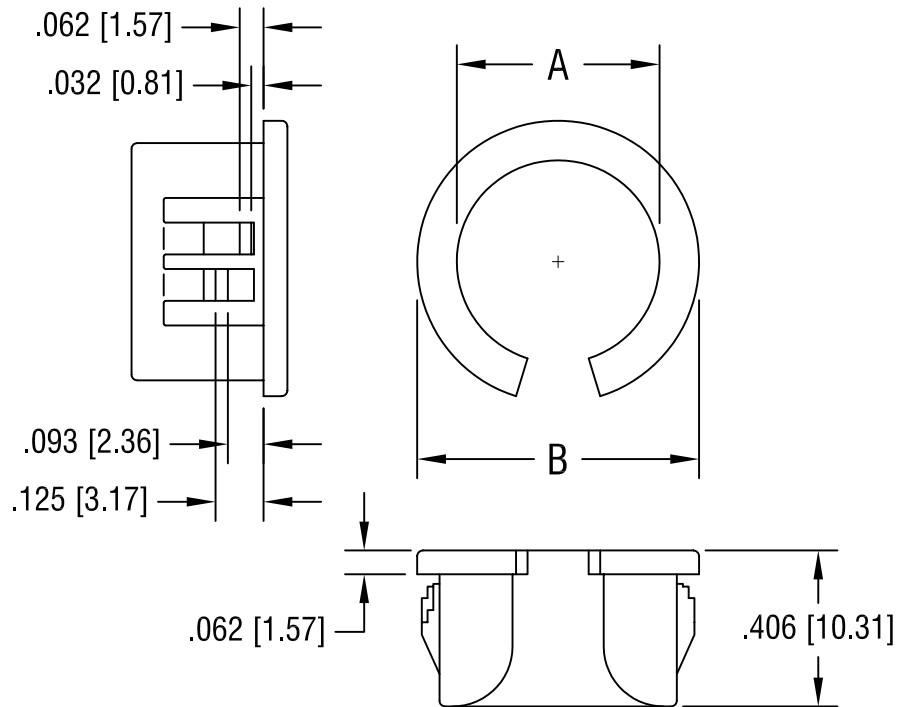

MOUNTING HOLE	'A' DIA.	'B' DIA.
.875 [22.23]	.671 [17.04]	.921 [23.39]

KEYSTONE ELECTRONICS CORP.

ASTORIA, N.Y. 11105-2017

PART NAME

NYLON SPLIT BUSHING

MATERIAL

NYLON 6/6, BLACK UL 94V-2

FINISH

-

DRN BY

BOONE

DATE

1.18.07

APP'D

LN

SCALE

NONE

TOLERANCES

INCH [MM]

DECIMAL $\pm .015$ [± 0.38]

ANGULAR $\pm 1^\circ$
UNLESS OTHERWISE SPECIFIED

CODE

C/M

DWG NO.

8495

DATE

DESCRIPTION

REV.