

# LAPT 2SA1386/1386A

Silicon PNP Epitaxial Planar Transistor (Complement to type 2SC3519/A)

Application : Audio and General Purpose

■ Absolute maximum ratings (Ta=25°C)

Symbol	Ratings		Unit
	2SA1386	2SA1386A	
VcBo	-160	-180	V
VcEO	-160	-180	V
VEBo	-5		V
Ic	-15		A
Ib	-4		A
Pc	130(Tc=25°C)		W
Tj	150		°C
Tstg	-55 to +150		°C

■ Electrical Characteristics (Ta=25°C)

Symbol	Conditions	Ratings		Unit
		2SA1386	2SA1386A	
IcBo	VcB=	-100max	-100max	μA
IEBo	VEB=-5V	-160	-180	μA
V(BR)CEO	Ic=-25mA	-160min	-180min	V
hFE	VCE=-4V, Ic=-5A	50min*		
VCE(sat)	Ic=-5A, Ib=-0.5A	-2.0max		V
fT	VCE=-12V, IE=2A	40typ		MHz
COB	VcB=-10V, f=1MHz	500typ		pF

\*hFE Rank O(50 to 100), P(70 to 140), Y(90 to 180)

■ Typical Switching Characteristics (Common Emitter)

VCC (V)	RL (Ω)	Ic (A)	VBB1 (V)	VBB2 (V)	IB1 (A)	IB2 (A)	ton (μs)	tstg (μs)	tf (μs)
-40	4	-10	-10	5	-1	1	0.3typ	0.7typ	0.2typ

External Dimensions MT-100(TO3P)

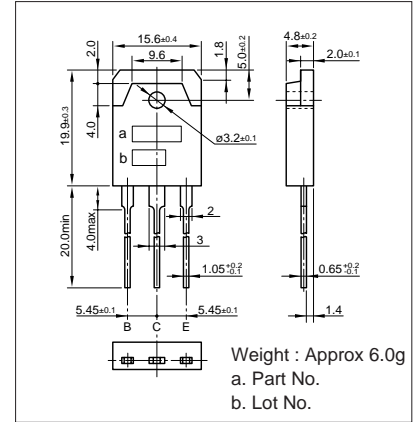

Weight : Approx 6.0g  
a. Part No.  
b. Lot No.

Ic-VCE Characteristics (Typical)

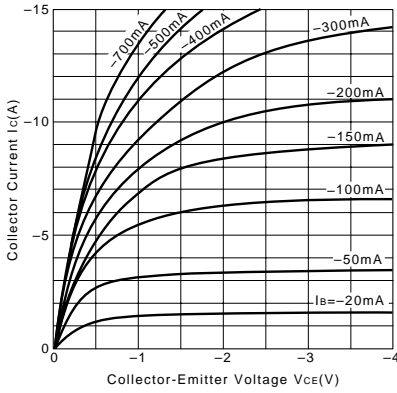

VCE(sat)-Ib Characteristics (Typical)

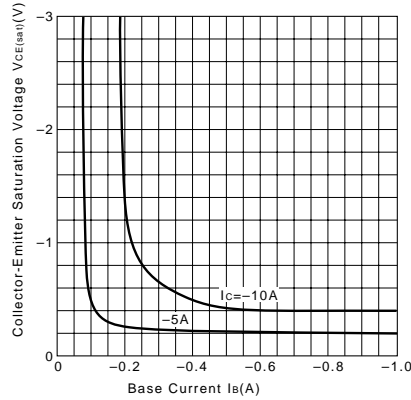

Ic-VBE Temperature Characteristics (Typical)

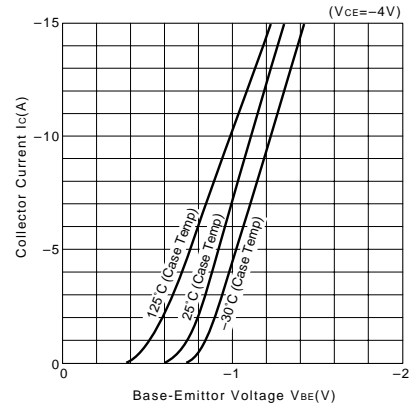

hFE-Ic Characteristics (Typical)

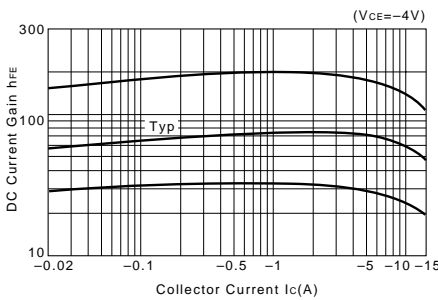

hFE-Ic Temperature Characteristics (Typical)

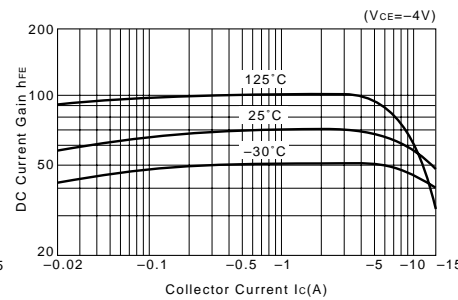

θj-a-t Characteristics

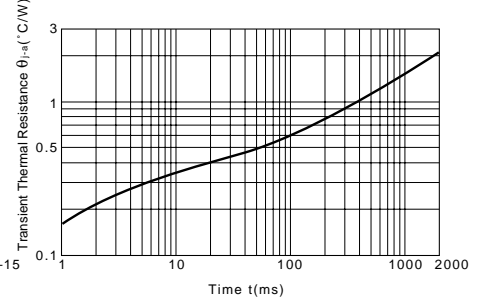

fT-IE Characteristics (Typical)

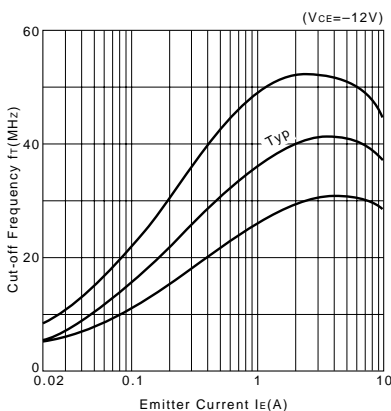

Safe Operating Area (Single Pulse)

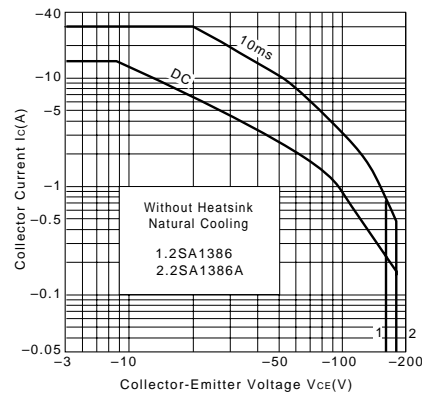

Pc-Ta Derating

