



MasterBlaster Serial/USB Communications Cable User Guide



101 Innovation Drive
San Jose, CA 95134
www.altera.com

Software Version: 80
Document Version: 1.1
Document Date: © July 2008

Copyright © 2008 Altera Corporation. All rights reserved. Altera, The Programmable Solutions Company, the stylized Altera logo, specific device designations, and all other words and logos that are identified as trademarks and/or service marks are, unless noted otherwise, the trademarks and service marks of Altera Corporation in the U.S. and other countries. All other product or service names are the property of their respective holders. Altera products are protected under numerous U.S. and foreign patents and pending applications, maskwork rights, and copyrights. Altera warrants performance of its semiconductor products to current specifications in accordance with Altera's standard warranty, but reserves the right to make changes to any products and services at any time without notice. Altera assumes no responsibility or liability arising out of the application or use of any information, product, or service described herein except as expressly agreed to in writing by Altera Corporation. Altera customers are advised to obtain the latest version of device specifications before relying on any published information and before placing orders for products or services.

Chapter 1. Installing the MasterBlaster Serial/USB Communications Cable

Introduction	1-1
Installation	1-1
Installation on a Windows PC	1-2
Installation on a Linux or UNIX Workstation	1-3
Selecting the MasterBlaster Cable for the SignalTap II Logic Analyzer	1-4

Chapter 2. MasterBlaster Serial/USB Communications Cable Data Sheet

Features	2-1
Functional Description	2-1
Download Modes	2-2
SignalTap II Logic Analysis	2-2
MasterBlaster Connections	2-3
Header & Plug Connections	2-3
Powering the MasterBlaster Cable	2-4
Circuit Board Header Connection	2-5
LED Status	2-5
Operating Conditions	2-5
References	2-7

Chapter Info. Additional Information

Referenced Documents	Info-1
Revision History	Info-1
How to Contact Altera	Info-1
Typographic Conventions	Info-2

List of Figures

Figure 1–1: MasterBlaster Serial/USB Communications Cable	1-2
Figure 1–2: The Hardware Setup Dialog Box	1-3
Figure 2–1: MasterBlaster Serial/USB Communications Cable	2-2
Figure 2–2: MasterBlaster 10-Pin Female Plug Dimensions	2-4
Figure 2–1: 10-Pin Male Header Dimensions	2-5

List of Tables

Table 2-1: MasterBlaster 9-Pin Serial D-Type Connector Pin-Outs	2-3
Table 2-2: MasterBlaster Female Plug's Pin Names & Download Modes	2-4
Table 2-1: LED Status Indicator	2-5
Table 2-2: MasterBlaster Cable Absolute Maximum Ratings	2-6
Table 2-3: MasterBlaster Cable Recommended Operating Conditions	2-6
Table 2-4: MasterBlaster Cable DC Operating Conditions	2-6

Introduction

The MasterBlaster™ serial/USB communications cable is a download cable that allows PC and workstation users to program and configure devices in-system. The MasterBlaster cable provides multi-device JTAG chain configuration and programming support for SRAM-based devices, such as APEX™ 20K and Mercury™ devices, EEPROM-based devices, such as MAX® 3000 and MAX 7000 devices, and configuration devices, such as the EPC2 and EPC16. You can also use the MasterBlaster cable to run SignalTap® II logic analysis. The MasterBlaster cable also provides multi-device passive serial (PS) chain configuration support for SRAM-based devices, such as APEX 20K and Mercury devices. This cable can be used in 2.5-, 3.3-, and 5.0-V systems.

Altera® offers a variety of hardware to program and configure Altera devices. For conventional device programming, in-system programming, and in-circuit reconfiguration, designers can choose from a wide range of programming hardware options.

This user guide provides the following information about the MasterBlaster™ serial/USB communications cable.

- How to install the cable and its driver software
- How to use the cable after installation
- A complete list of the cable's features
- A functional description of the cable

Installation

The MasterBlaster communications cable connects a circuit board to the USB (Windows 2000, Windows XP x32 edition, and Windows Vista x32 edition only) or RS-232 serial port (called a COM port on a PC) on a PC, UNIX, or Linux workstation. The 10-pin female plug for the cable connects to a 10-pin male header on the circuit board that contains the target device(s), as shown in [Figure 1-1](#). Programming or configuration data can be downloaded from the serial or USB port, using the Quartus® II Programmer, through the MasterBlaster cable to the circuit board through these connections.



The Quartus II software version 8.1 and later will no longer support MasterBlaster communication cable.

The MasterBlaster communications cable receives power from any one of the following sources:

- 5.0- or 3.3-V circuit boards
- 5.0 V from the USB cable (Windows 2000, Windows XP x32 edition, and Windows Vista x32 edition only)

- DC power supply, which is supplied with the MasterBlaster communications cable
- The MasterBlaster cable connects to a computer through a serial or USB port, and connects to the circuit board through a standard 10-pin female connector.

Installation on a Windows PC

To install and set up the MasterBlaster cable for device configuration or programming on a Windows PC, follow these steps:

1. Connect one end of a standard RS-232 cable or a standard USB cable, to the MasterBlaster cable and connect the other end to the appropriate port on the computer.



If you are using the MasterBlaster communications cable with the USB port, the Windows 2000, Windows XP, or Windows Vista operating system prompts you to locate the MasterBlaster USB driver **mbblaster.inf** file. The MasterBlaster driver is located in your `\<Quartus II system directory>\drivers` directory.

2. Connect the 16-pin female header end of the cable to the 16-pin male MasterBlaster port, and the 10-pin female end of the cable to the 10-pin male header on the target printed circuit board. [Figure 1-1](#) shows the MasterBlaster serial/USB communications cable.

Figure 1-1. MasterBlaster Serial/USB Communications Cable



3. Open the Quartus II Programmer. Choose **Programmer** (Tools menu) or choose **New** (File menu). Click the **Other Files** tab, select **Chain Description File**, and click **OK**.
4. In the Programmer window, click **Hardware Setup**. The **Hardware Settings** tab of the **Hardware Setup** dialog box is displayed.
5. Click **Add Hardware**. The **Add Hardware** dialog box is displayed.
6. In the **Hardware type** list, select either **MasterBlaster (COM)** or **MasterBlaster (USB)**.



-  The **USB** option is available only for Windows 2000, Windows XP x32 edition and Windows Vista x32 edition systems.
 -  The **COM** option is available only for Windows 2000, Windows XP x32 edition, Windows XP x64 edition and Windows Vista x32 edition systems.
7. In the **Port** list, select the appropriate port.
 8. If you are using a serial port, in the **Baud rate** list, select a baud rate appropriate for your computer.
 9. Click **OK** to close the **Add Hardware** dialog box. You will see **MasterBlaster** in the **Available hardware items** section of the **Hardware Setup** dialog box.
 10. Click on **MasterBlaster** to highlight it, then click on the **Select Hardware** button to the right of the **Available hardware items** section. You will now see **MasterBlaster** and your selected port in the **Currently selected hardware** section of the window, as shown in [Figure 1-2](#).
 11. Click **Close** to close the **Hardware Setup** dialog box.

Figure 1-2. The Hardware Setup Dialog Box



12. Close the Programmer window.

Installation on a Linux or UNIX Workstation

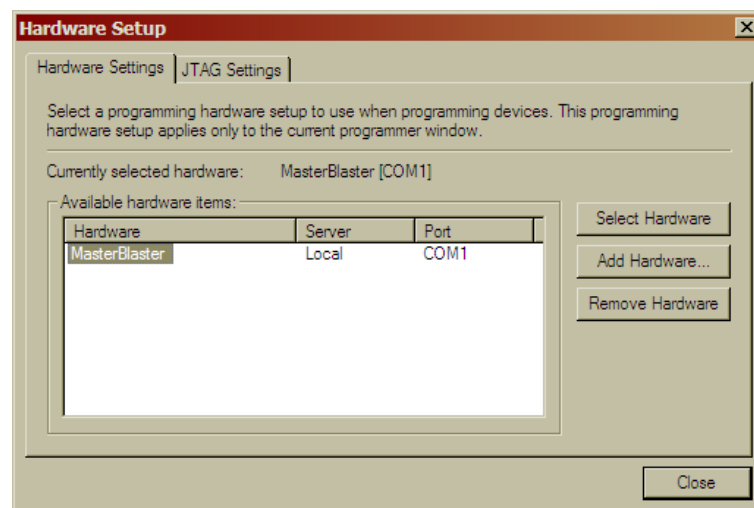
To install and set up the MasterBlaster cable for device configuration or programming on a Linux or UNIX Workstation, follow these steps:

1. With a standard RS-232 cable, connect one end of the cable to the MasterBlaster cable, and connect the other end of the cable to the appropriate port on the computer.
2. Connect the 16-pin female header end of the cable to the 16-pin male MasterBlaster port, and the 10-pin female end of the cable to the 10-pin male header on the target printed circuit board, as shown in [Figure 1-1](#).

3. Open the Quartus II Programmer. Choose **Programmer** (Tools menu) or choose **New** (File menu). Click the **Other Files** tab, select **Chain Description File**, and click **OK**.
4. In the Programmer window, click **Hardware Setup**. The **Hardware Settings** tab of the **Hardware Setup** dialog box is displayed.
5. Click **Add Hardware**. The **Add Hardware** dialog box is displayed.
6. In the **Hardware type** list, select **MasterBlaster**.
7. In the **Port** box, select the name of the appropriate serial port. Also, make sure you have read and write permission for the serial port.
8. In the **Baud rate** list, select a baud rate that is appropriate for your computer.
9. Click **OK**.
10. In the **Hardware Setup** dialog box, click **Close**.

Selecting the MasterBlaster Cable for the SignalTap II Logic Analyzer

To select the MasterBlaster communications cable for the SignalTap II Logic Analyzer, follow these steps.

1. Choose **SignalTap II Logic Analyzer** (Tools menu). The SignalTap window will open.
2. Under **JTAG Chain Configuration**, select **MasterBlaster** in the **Hardware** pull-down list.

If the MasterBlaster cable does not appear in the **Hardware** list, continue as follows:

1. Under **JTAG Chain Configuration**, click **Setup**.
2. Click **Add Hardware** in the **Hardware Setup** dialog box to add a hardware setup for the MasterBlaster cable.
3. Click **Add Hardware** in the **Hardware Setup** dialog box to add a hardware setup for the communications cable.



For more information about SignalTap II logic analysis with the MasterBlaster cable, refer to *Selecting the Communications Cable for the SignalTap II Logic Analyzer* in the Quartus II Help.

Features

- Supports SignalTap® II logic analysis in the Altera® Quartus® II software
- Allows PC, Linux, and UNIX users to perform the following functions:
 - Configure Stratix® IV, Stratix III, Stratix II, Stratix II GX, Stratix, Stratix GX, Cyclone™ III, Cyclone II, Cyclone, Mercury™, APEX™ II, APEX 20K, FLEX® 10K, FLEX 3000A, FLEX 6000, FLEX 8000 devices, and Excalibur™ embedded processor solutions
 - Program MAX® II, MAX 9000, MAX 7000S, MAX 7000B, MAX 7000A, EPC2, EPC4, EPC8, and EPC16 devices in-system
- Supports operation with VCC at 5.0 V, 3.3 V, or 2.5 V
- Provides a fast, low-cost method for in-system programming
- Downloads data from the Quartus II development software and the MAX+PLUS® II software versions 9.3 and higher
- Interfaces with an RS-232 serial or universal serial bus (USB) port
- Uses a 10-pin circuit board connector

Functional Description

The MasterBlaster™ serial/USB communications cable (ordering code: PL-MASTERBLASTER) is a standard PC serial or USB port hardware interface (see [Figure 2-1](#)). This cable downloads configuration data to Stratix IV, Stratix III, Stratix II, Stratix II GX, Stratix, Stratix GX, Cyclone III, Cyclone II, Cyclone, Mercury, APEX II, APEX 20K (including APEX 20K, APEX 20KE, and APEX 20KC), FLEX 10K (including FLEX 10KA and FLEX 10KE), FLEX 8000, and FLEX 6000 devices, as well as programming data to MAX II, MAX 9000, MAX 7000S, and MAX 7000A (including MAX 7000AE) devices. Because design changes are downloaded directly to the device, prototyping is easy and multiple design iterations can be accomplished in quick succession. The MasterBlaster cable also supports in-circuit debugging with the SignalTap II embedded logic analyzer in Stratix, APEX II, and APEX 20K devices.

Figure 2-1. MasterBlaster Serial/USB Communications Cable

Download Modes

The MasterBlaster cable provides two download modes:

- **Passive serial mode (PS)**—In this mode the Quartus II Programmer can configure all Altera devices supported by the Quartus II software except MAX 3000 and MAX 7000 devices.
- **JTAG mode**—Industry-standard IEEE Std. 1149.1 Joint Test Action Group (JTAG) interface for programming JTAG-capable devices. In JTAG mode, the Quartus II Programmer can program or configure all Altera devices supported by the Quartus II software, except FLEX 6000 devices. FLEX 6000 devices can be in a JTAG chain, but they must be bypassed; they cannot be configured. The Quartus II Programmer can also program EPC2, EPC4, EPC8, and EPC16 configuration devices in this mode. The JTAG chain can contain any number and combination of Altera and non-Altera devices that comply with this IEEE 1149.1 specification.

SignalTap II Logic Analysis

The SignalTap II logic analysis enables captured device data at specified trigger points and stores the data in APEX II and APEX 20K embedded system blocks (ESBs). This data is then sent to the JTAG IEEE Std. 1149.1 port of an APEX II or APEX 20K device, uploaded through the MasterBlaster communications cable, and displayed in the Quartus II Waveform Editor.



For more information on SignalTap logic analysis, see the *Design Debugging using the SignalTap II Embedded Logic Analyzer* chapter in volume 3 of the *Quartus II Handbook*.

MasterBlaster Connections

The MasterBlaster cable connects to a computer through a serial or USB port and connects to the circuit board through a standard 10-pin female connector. Data is downloaded from the serial or USB port through the MasterBlaster cable to the circuit board through the connections discussed in this section.

Header & Plug Connections

The 9-pin male D-type connector connects to an RS-232 port with a standard serial cable. See [Table 2-1](#).



The USB connector can be used with any standard USB cable.

Table 2-1. MasterBlaster 9-Pin Serial D-Type Connector Pin-Outs

Pin	Signal Name	Description
2	rx	Receive data
3	tx	Transmit data
4	dtr	Data terminal ready
5	GND	Signal ground
6	dsr	Data set ready
7	rts	Request to send
8	cts	Clear to send



For more information on 9-pin versus 25-pin serial connectors, search for “9-pin or 25-pin serial connectors” in the Altera solutions database at www.altera.com.

The 10-pin female plug connects to a 10-pin male header on the circuit board containing the target device(s). [Figure 2-2](#) shows the dimensions of the female plug.

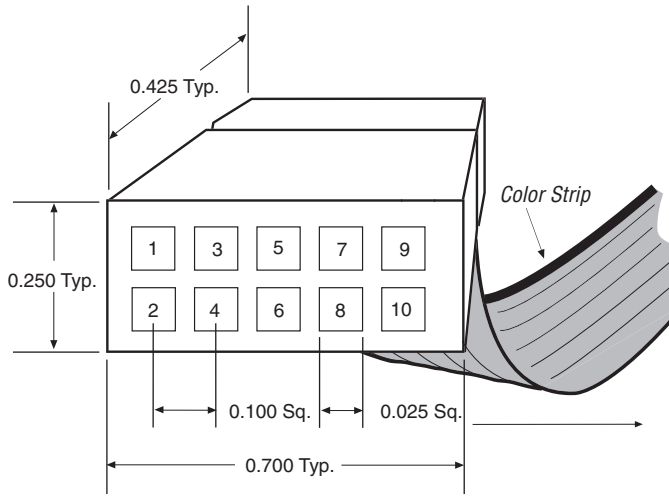
Figure 2–2. MasterBlaster 10-Pin Female Plug Dimensions

Dimensions are shown in inches. The spacing between pin centers is 0.1 inches.

Table 2–2 identifies the 10-pin female plug's pin names for the corresponding download mode.

Table 2–2. MasterBlaster Female Plug's Pin Names & Download Modes

Pin	PS Mode		JTAG Mode	
	Signal Name	Description	Signal Name	Description
1	dclk	Clock signal	tck	Clock signal
2	gnd	Signal ground	gnd	Signal ground
3	CONF_DONE	Configuration control	tdo	Data from device
4	V _{CC}	Power supply	V _{CC}	Power supply
5	nCONFIG	Configuration control	tms	JTAG state machine control
6	V _{IO}	Reference voltage for MasterBlaster output driver	V _{IO}	Reference voltage for MasterBlaster output driver
7	nstatus	Configuration status	–	No connect
8	–	No connect	–	No connect
9	data0	Data to device	tdi	Data to device
10	gnd	Signal ground	gnd	Signal ground

Powering the MasterBlaster Cable

The MasterBlaster cable can receive power from the following sources:

- 5.0- or 3.3-V circuit boards
- DC power supply
- 5.0 V from the USB cable

When 5.0- or 3.3-V power is not available on the circuit board, the MasterBlaster cable can be powered by either DC power or the USB cable.

 For the MasterBlaster cable’s output drivers, connect the circuit board’s V_{CC} and ground to the MasterBlaster cable’s VCC, VIO, and GND pins.

Circuit Board Header Connection

The MasterBlaster cable’s 10-pin female plug connects to a 10-pin male header on the circuit board. The 10-pin male header has two rows of five pins, which are connected to the device’s programming or configuration pins. Figure 2-1 shows the dimensions of a typical 10-pin male header.

 Although a 10-pin surface mount header can be used for the JTAG, AS or PS download cable, Altera recommends using a through-hole connector due to the repeated insertion and removal force needed.

Figure 2-1. 10-Pin Male Header Dimensions



LED Status

The purpose of the LED indicator lights located on the MasterBlaster download cable is to provide information about the status of the MasterBlaster cable. Table 2-1 lists the indicator and status of the MasterBlaster cable.

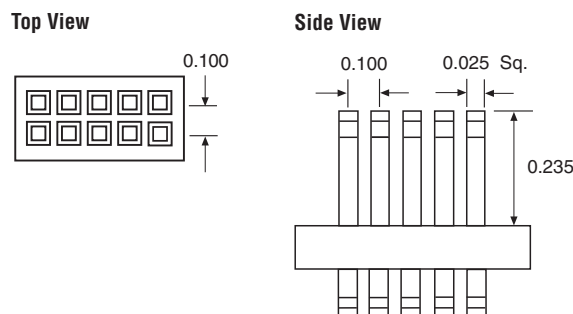
Table 2-1. LED Status Indicator

Color	Blink Frequency	Description
Green	Slow	Cable ready
Green	Fast	Performing a logic analysis
Amber	Slow	Programming in progress

Operating Conditions

Table 2-2 through 2-6 summarize the absolute maximum ratings, recommended operating conditions, and DC operating conditions for the MasterBlaster cable.

Table 2-2. MasterBlaster Cable Absolute Maximum Ratings

Symbol	Parameter	Conditions	Min	Max	Unit
V_{CC}	Supply voltage	With respect to ground	-0.5	7.0	V
V_I	DC input voltage	With respect to ground	-0.5	7.0	V

Table 2-3. MasterBlaster Cable Recommended Operating Conditions (Note 1), (2)

Symbol	Parameter	Conditions	Min	Max	Unit
V_{CC}	Board header supply voltage, 5.0-V operation	—	4.5	5.5	V
	Board header supply voltage, 3.3-V operation	—	3.0	3.6	V

Notes for Table 2-3

- (1) The DC adapter supply voltage has a minimum value of 3.0 V, a maximum value of 16.0 V, and a power consumption of 1 W (V_{CC} can be at 5.0 V, 3.3 V, or 2.5 V).
- (2) The 5.0-V USB cable supply voltage has a minimum value of 4.5 V and a maximum value of 5.5 V (V_{CC} can be at 5.0 V, 3.3 V, or 2.5 V).

Table 2-4. MasterBlaster Cable DC Operating Conditions

Symbol	Parameter	Conditions	Min	Max	Unit
V_{IH}	High-level input voltage	$V_{CC} = V_{IO}$	$0.25 \nless V_{IO} + 0.3$ V		V
V_{IL}	Low-level input voltage	$V_{CC} = V_{IO}$		$0.25 \nless V_{IO}$	V
V_{OH}	5.0-V high-level TTL output voltage	TTL load. $V_{CC} = V_{IO} = 4.5$ V, $I_{OH} = 8$ mA	3.2		V
	3.3-V high-level TTL output voltage	TTL load. $V_{CC} = V_{IO} = 3.0$ V, $I_{OH} = 4$ mA	2.4		V
	5.0-V high-level CMOS output voltage	CMOS load. $V_{CC} = V_{IO} = 4.5$ V, $I_{OH} = 0.1$ mA	4.0		V
	3.3-V high-level CMOS output voltage	CMOS load. $V_{CC} = V_{IO} = 3.0$ V, $I_{OH} = 0.1$ mA	2.7		V
	2.5-V high-level CMOS output voltage	CMOS load. $V_{CC} = V_{IO} = 2.3$ V, $I_{OH} = 0.1$ mA	2.0		V
V_{OL}	5.0-V low-level TTL output voltage	TTL load. $V_{CC} = V_{IO} = 4.5$ V, $I_{OL} = 8$ mA		0.4	V
	3.3-V low-level TTL output voltage	TTL load. $V_{CC} = V_{IO} = 3.0$ V, $I_{OL} = 4$ mA		0.4	V
	5.0-V low-level CMOS output voltage	CMOS load. $V_{CC} = V_{IO} = 4.5$ V, $I_{OL} = 0.1$ mA		0.1	V
	3.3-V low-level CMOS output voltage	CMOS load. $V_{CC} = V_{IO} = 3.0$ V, $I_{OL} = 0.1$ mA		0.1	V
	2.5-V low-level CMOS output voltage	CMOS load. $V_{CC} = V_{IO} = 2.3$ V, $I_{OL} = 0.1$ mA		0.1	V
P	Operating power			1.0	W

References

For more information on configuration and in-system programmability (ISP), see the following sources:

- *The Altera Configuration Handbook*
- *AN 95: In-System Programmability in MAX Devices*
- *AN 100: In-System Programmability Guidelines*
- *APEX 20K Programmable Logic Device Family Data Sheet*
- *FLEX 10K Embedded Programmable Logic Family Data Sheet*
- *FLEX 8000 Programmable Logic Device Family Data Sheet*
- *FLEX 6000 Programmable Logic Device Family Data Sheet*
- *MAX 9000 Programmable Logic Device Family Data Sheet*
- *MAX 7000 Programmable Logic Device Family Data Sheet*
- *MAX 7000A Programmable Logic Device Family Data Sheet*
- *Design Debugging using the SignalTap II Embedded Logic Analyzer* chapter in volume 3 of the *Quartus II Handbook*

Referenced Documents

- Refer to the following introduction and overview topics in Quartus® II Help:
 - Selecting the Communications Cable for the SignalTap II Logic Analyzer

Revision History

The table below displays the revision history for the chapters in this user guide.

Date and Document Version	Changes Made	Summary of Changes
July 2008, v1.1	<ul style="list-style-type: none"> ■ General Style and Formatting update. ■ Added the “Additional Information” chapter. ■ Added Windows Vista to the supported operating system. ■ Updated the “Features” section. ■ Updated the “Functional Description” section. ■ Updated the “Download Modes” section. 	—
July 2004, v1.0	Initial release.	—

How to Contact Altera

For the most up-to-date information about Altera® products, refer to the following table.







Contact (1)	Contact Method	Address
Technical support	Website	www.altera.com/support
Technical training	Website	www.altera.com/training
	Email	custrain@altera.com
Product literature	Website	www.altera.com/literature
Altera literature services	Email	literature@altera.com
Non-technical support (General) (Software Licensing)	Email	nacomp@altera.com
	Email	authorization@altera.com

Note to table:

(1) You can also contact your local Altera sales office or sales representative.

Typographic Conventions

This document uses the typographic conventions shown below.

Visual Cue	Meaning
Bold Type with Initial Capital Letters	Command names, dialog box titles, checkbox options, and dialog box options are shown in bold, initial capital letters. Example: Save As dialog box.
bold type	External timing parameters, directory names, project names, disk drive names, filenames, filename extensions, and software utility names are shown in bold type. Examples: f_{MAX} , \qdesigns directory, d: drive, chiptrip.gdf file.
<i>Italic Type with Initial Capital Letters</i>	Document titles are shown in italic type with initial capital letters. Example: <i>AN 75: High-Speed Board Design</i> .
<i>Italic type</i>	Internal timing parameters and variables are shown in italic type. Examples: <i>t_{PIA}</i> , <i>n + 1</i> . Variable names are enclosed in angle brackets (< >) and shown in italic type. Example: <i><file name></i> , <i><project name>.pof</i> file.
Initial Capital Letters	Keyboard keys and menu names are shown with initial capital letters. Examples: Delete key, the Options menu.
"Subheading Title"	References to sections within a document and titles of on-line help topics are shown in quotation marks. Example: "Typographic Conventions."
Courier type	Signal and port names are shown in lowercase Courier type. Examples: <code>data1</code> , <code>tdi</code> , <code>input</code> . Active-low signals are denoted by suffix <code>n</code> , for example, <code>resetn</code> . Anything that must be typed exactly as it displays is shown in Courier type. For example: <code>c:\qdesigns\tutorial\chiptrip.gdf</code> . Also, sections of an actual file, such as a Report File, references to parts of files (for example, the AHDL keyword <code>SUBDESIGN</code>), as well as logic function names (e.g., <code>TRI</code>) are shown in Courier.
1., 2., 3., and a., b., c., etc.	Numbered steps are used in a list of items when the sequence of the items is important, such as the steps listed in a procedure.
	Bullets are used in a list of items when the sequence of the items is not important.
	The checkmark indicates a procedure that consists of one step only.
	The hand points to information that requires special attention.
	A caution calls attention to a condition or possible situation that can damage or destroy the product or the user's work.
	A warning calls attention to a condition or possible situation that can cause injury to the user.
	The angled arrow indicates you should press the Enter key.
	The feet direct you to more information about a particular topic.