



User Manual

DS-280

OPS Signage Player for Real 4K Triple Outputs

ADVANTECH

Enabling an Intelligent Planet

Copyright

The documentation and the software included with this product are copyrighted 2017 by Advantech Co., Ltd. All rights are reserved. Advantech Co., Ltd. also reserves the right to improve the products described in this manual at any time without notice. No part of this manual may be reproduced, copied, translated, or transmitted in any form or by any means without the prior written permission of Advantech Co., Ltd. Information provided in this manual is intended to be accurate and reliable. However, Advantech Co., Ltd. assumes no responsibility for its use, nor for any infringements on the rights of third parties that may result from its use.

Acknowledgements

Award is a trademark of Award Software International, Inc.

IBM, PC/AT, PS/2 and VGA are trademarks of International Business Machines Corporation.

Intel® and ATOM® are trademarks of Intel Corporation.

RTL is a trademark of Realtek Semi-Conductor Co., Ltd..

ESS is a trademark of ESS Technology, Inc.

UMC is a trademark of United Microelectronics Corporation.

SMI is a trademark of Silicon Motion, Inc.

Creative is a trademark of Creative Technology LTD.

CHRONTEL is a trademark of Chrontel Inc.

All other product names or trademarks are properties of their respective owners.

For more information about this and other Advantech products, please visit our website at <http://www.advantech.com/>

For technical support and services, please visit our support website at <http://support.advantech.com.tw/support/>

Product Warranty (2 years)

Advantech warrants the original purchaser that each of its products will be free from defects in materials and workmanship for two years from the date of purchase.

This warranty does not apply to any products that have been repaired or altered by persons other than repair personnel authorized by Advantech, or products that have been subject to misuse, abuse, accident, or improper installation. Advantech assumes no liability under the terms of this warranty as a consequence of such events.

Because of Advantech's high quality-control standards and rigorous testing, most customers never need to use our repair service. If an Advantech product is defective, it will be repaired or replaced at no charge during the warranty period. For out-of-warranty repairs, customers are billed according to the cost of replacement materials, service time, and freight. Please consult your dealer for more details.

If you suspect your product to be defective, follow the steps listed below:

1. Collect all information about the problem encountered (for example, CPU speed, Advantech products used, other hardware and software used, etc.). Note anything abnormal and list any onscreen messages displayed when the problem occurs.
2. Call your dealer and describe the problem. Please have the manual, product, and any relevant information readily available.
3. If your product is diagnosed as defective, obtain an RMA (return merchandise authorization) number from your dealer. This allows us to process your return more quickly.
4. Carefully pack the defective product, a completed Repair and Replacement Order Card, and proof of the purchase date (such as a photocopy of your sales receipt) in a shippable container. Products returned without proof of purchase date are not eligible for warranty service.
5. Write the RMA number clearly on the outside of the package; then ship the product prepaid to your dealer.

Declaration of Conformity

FCC Class B

Note: This equipment has been tested and found to comply with the limits for a Class B digital device, pursuant to part 15 of the FCC Rules.

These limits are designed to provide reasonable protection against harmful interference when the equipment is operated in a commercial environment. This equipment generates, uses, and can radiate radio frequency energy and, if not installed and used in accordance with the instruction manual, may cause harmful interference to radio communications. Operation of this equipment in a residential area is likely to cause harmful interference in which case the user will be required to correct the interference at his own expense.

Technical Support and Assistance

1. Visit the Advantech website at <http://support.advantech.com> for the latest product information.
2. Contact your distributor, sales representative, or Advantech's customer service center for technical support if you require additional assistance. Please have the following information ready before calling:
 - Product name and serial number
 - Description of your peripheral attachments
 - Description of your software (operating system, version, application software, etc.)
 - A complete description of the problem
 - The exact wording of any error messages

Warnings, Cautions, and Notes

Warning! *Warnings indicate conditions, which if not observed, can cause personal injury!*



Caution! *Cautions are included to help users avoid hardware damage and data losses.*



For example,

“New batteries are at risk of exploding if incorrectly installed. Do not attempt to recharge, force open, or heat the battery. Replace the battery only with the same or equivalent type recommended by the manufacturer. Discard used batteries according to the manufacturer's instructions.”

Note! *Notes provide additional information.*



Packing List

Before installation, please ensure that the following items have been shipped:

- 1 x DS-280 unit
- 1 x Simple Chinese User Manual
- 1 x Traditional Chinese User Manual
- 1 x accessory box includes Signage Software (WISE-PaaS/RMM & WebAccess/IMM) CD Package
- 1x China RoHS
- 1 x Warranty Card

Safety Instructions

1. Read these safety instructions carefully.
2. Retain this user manual for future reference.
3. Disconnect this equipment from all AC outlets before cleaning. Do not use liquid or spray detergents for cleaning. Instead, use only a damp cloth.
4. For pluggable equipment, the power outlet socket should be located nearby and easily accessible.
5. Protect this equipment from humidity.
6. Place this equipment on a reliable surface during installation. Dropping or letting the equipment fall can cause damage.
7. The openings on the enclosure are for air convection to protect the equipment from overheating. Do not cover the openings.
8. Ensure that power voltage is correct before connecting the equipment to a power outlet.
9. Position the power cord so that people cannot step on it. Do not place anything over the power cord.
10. All cautions and warnings on the equipment should be noted.
11. If not used for a long time, disconnect the equipment from the power source to avoid damage by transient overvoltage.
12. Never pour liquid into the openings. This can cause fire or electrical shock.
13. Never open the equipment. For safety reasons, the equipment should only be opened by qualified service personnel.
14. If one of the following occurs, have the equipment checked by authorized service personnel:
 - The power cord or plug is damaged.
 - Liquid has penetrated the equipment.
 - The equipment has been exposed to moisture.
 - The equipment is malfunctioning, or does not operate according to the user manual.
 - The equipment has been dropped or damaged.
 - The equipment shows obvious signs of breakage.
15. Do not store this equipment in an environment where the temperature fluctuates below -20 °C (-4 °F) or above 60 °C (140 °F) as this can cause damage. The equipment should be stored in a controlled environment.
16. **CAUTION:** Batteries are at risk of exploding if incorrectly installed. Replace only with the same or equivalent type recommended by the manufacturer. Discard used batteries according to the manufacturer's instructions.

The sound pressure at the operator position does not exceed 70 dB (A), as per IEC 704-1:1982.

DISCLAIMER: These instructions are provided according to IEC 704-1. Advantech disclaims all responsibility for the accuracy of all statements contained herein.

Contents

Chapter 1	General Introduction	1
1.1	Introduction	2
1.2	Product Features.....	2
1.2.1	Key Features.....	2
1.2.2	Display	2
1.2.3	Power Consumption.....	2
1.3	Hardware Specifications	3
1.4	Mechanical Specifications	4
1.4.1	Dimensions	4
	Figure 1.1 DS-280 Mechanical Dimensions (Unit: mm).....	4
1.4.2	Weight.....	4
1.5	Power Requirements.....	4
1.5.1	System Power:.....	4
1.5.2	RTC Battery:	5
1.6	Environmental Specifications	5
1.6.1	Operating Temperature.....	5
1.6.2	Relative Humidity	5
1.6.3	Storage Temperature.....	5
1.6.4	Vibration Loading During Operation (HDD)	5
1.6.5	Safety.....	5
1.6.6	EMC	5
Chapter 2	I/O Connectors	7
2.1	DS-280 I/O Connectors.....	8
2.1.1	Front I/O.....	8
2.1.2	Rear I/O	8
2.2	DS-280 External I/O Connectors.....	8
2.2.1	Power ON/OFF Button.....	8
	Figure 2.1 Power Button	8
2.2.2	USB3.0 Connectors	8
	Figure 2.2 USB3.0 Connector.....	8
	Table 2.1: USB3.0 Port Pin Assignments.....	9
2.2.3	Ethernet Connector (LAN)	9
	Figure 2.3 GLAN Connector	9
	Table 2.2: LAN Connector Pin Assignments	9
2.2.4	Audio Connector	9
	Figure 2.4 Line-out connector.....	9
2.2.5	HDMI2.0.....	10
	Figure 2.5 HDMI Connector.....	10
	Table 2.3: HDMI Pin out	10
2.2.6	DisplayPort1.2.....	10
	Figure 2.6 DisplayPort Connector.....	10
	Table 2.4: DisplayPort Connector.....	10
2.2.7	JAE TX-25A Connector.....	11
	Figure 2.7 JAE TX-25A 80-pin Connector	11
	Table 2.5: JAE-TX-25A Pin out	11
Chapter 3	Hardware Installation	13
3.1	Hardware Installation	14
3.1.1	Installation Ways for Displays	14
3.1.2	Storage Installation	14

	Figure 3.1 HDD Installation	14
3.1.3	Memory 1 Installation.....	15
	Figure 3.2 Memory 1 Installation	15
3.1.4	Memory 2 Installation.....	16
	Figure 3.3 Memory 2 Installation	16
3.1.5	mini-PCIe & SIM card installation	17
	Figure 3.4 mini-PCIe/ SIM card Installation	17
3.1.6	Antenna Installation (Optional)	18
	Figure 3.5 Antenna Installation (Optional)	18

Chapter 4 BIOS Settings 19

4.1	BIOS Introduction.....	20
4.2	Entering Setup	21
4.2.1	Main Setup.....	21
	Figure 4.1 Main setup	21
4.2.2	Advanced Features Setup	22
	Figure 4.2 Advanced Features setup	22
	Figure 4.3 ACPI setup	23
	Figure 4.4 AMT configuration setup	24
	Figure 4.5 ME Firmware Information	25
	Figure 4.6 ME Firmware Update configuration setup	25
	Figure 4.7 ITE8528E super IO configuration screen	26
	Figure 4.8 Serial Port 1 configuration setup	27
	Figure 4.9 ITE8528E HW Monitor status	28
	Figure 4.10 Watchdog Timer setup	28
	Figure 4.11 S5 RTC wake screen	29
	Figure 4.12 S5 RTC wake enabled setup.....	29
	Figure 4.13 Serial port console redirection setup	30
	Figure 4.14 Console redirection setup.....	31
	Figure 4.15 Legacy console redirection setup.....	31
	Figure 4.16 Console redirection settings	32
	Figure 4.17 CPU configuration information	33
	Figure 4.18 CPU configuration setup (continued)	34
	Figure 4.19 Intel® TXT information	35
	Figure 4.20 SATA configuration setup.....	36
	Figure 4.21 Network Stack configuration disabled screen	37
	Figure 4.22 Network Stack configuration enabled setup	37
	Figure 4.23 CSM configuration enabled setup	38
	Figure 4.24 USB configuration setup.....	39
4.2.3	Chipset.....	40
	Figure 4.25 Chipset screen	40
	Figure 4.26 System Agent setup	41
	Figure 4.27 Graphic configuration setup	42
	Figure 4.28 GT-Power Management Control settings	42
	Figure 4.29 PCH-IO configuration setup	43
	Figure 4.30 PCI Express configuration setup	44
	Figure 4.31 PCI Express Gen3 Eq Lanes setup.....	45
	Figure 4.32 Mini PCI Express setup	46
	Figure 4.33 Mini PCI Express setup (continued)	47
	Figure 4.34 USB configuration setup.....	47
	Figure 4.35 HD-Audio device setup.....	48
4.2.4	Security.....	49
	Figure 4.36 Security screen.....	49
4.2.5	Boot	50
	Figure 4.37 Boot setup	50
4.2.6	Save & Exit	51
	Figure 4.38 Save & Exit settings	51

Chapter 1

General Introduction

This chapter gives background information regarding the DS-280 series.

1.1 Introduction

DS-280 is the first OPS (Open Pluggable Standard) solution of digital signage players to support triple displays, which is powered by the latest 6th generation Intel® Core™ i7/ i5/ i3 BGA processor. It also deliver the exceptional graphic performance by Intel® HD Graphics 530, supporting HEVC/265, AVC/264, MPEG2, VC1/WMV9, VP8, JPEG/MJPEG, VP9 video formats.

DS-280 adopts the latest interfaces to fulfill the customer's advanced requirements, such HDMI 2.0 and DP1.2 supports 4096 x 2160 @60Hz maximum resolution, and DDR4 2133MHz SO-DIMM with dual channel (maximum capacity for 32GB, 16GB per SO-DIMM).

To follow Intel's OPS standard, slot-in and cable-less design is able to save installation and maintain costs, as well as simplify usage, maintenance, and upgrading process. Moreover, OPS design is the best solution to widely used in the institute and education applications.

1.2 Product Features

1.2.1 Key Features

- 6th Gen. Intel® Core™ i7-6822EQ/ i5-6442EQ/ i3-6102E, TDP up to 25W
- Creative triple outputs by front HDMI 2.0, DP1.0, and rear JAE 80-pin connector
- Support Real 4K (4096 x 2130 @60Hz) resolution by HDMI2.0 & DP1.2
- Easily install and maintain following Intel® OPS slot-in design
- Microsoft Windows 10 with proven compatibility

1.2.2 Display

- Triple independent displays from DS-280 are designed by front HDMI 2.0 & DP 1.2, and rear JAE 80-pin connector.
 - HDMI 2.0 supports Real 4K (4096 x 2160 @60Hz)
 - DP 1.2 supports Real 4K (4096 x 2160 @60Hz)
 - JAE 80-pin connector supports either HDMI1.4 4096x2160@24Hz or DP1.2 4096x 2304@60Hz (DP can't display under DOS)

1.2.3 Power Consumption

- Max: 26.12W; Idle: 6.35W (12V DC-in input with Core i7-6822EQ)
- Max: 28.80W; Idle: 6.46W (19V DC-in input with Core i7-6822EQ)

1.3 Hardware Specifications

- **CPU** (TDP up to 25W)
 - Intel® Core™ i7-6822EQ, Quad-core, 2.0GHz, AMT function supported
 - Intel® Core™ i5-6442EQ, Quad-core, 1.9GHz, AMT function supported
 - Intel® Core™ i3-6102E, Dual-core, 1.9GHz
- **System Chipset:** QM170
- **Graphic Chipset:** Intel® HD Graphics 530
- **System Memory:**
 - 2 x 260-pin DDR4 2133MHz SO-DIMM sockets
 - Maximum capacity: 32GB (16GB per SO-DIMM)
- **Storage:**
 - 1x 2.5" SATAIII (max. 7mm height)
 - 1x mSATA by full-size mini-PCIe interface (option)
- **WatchDog timer:** 1-255 seconds, supported by Advantech SUSI4.0 API
- **I/O Interface**
 - 1x JAE TX25A 80-pin connector
 - 1x HDMI 2.0
 - 1x DP 1.2
 - 3x USB3.0
 - 1x Line-out (Realtek ALC892, High Definition Audio; supports Jack Sense via OS setting)
 - 2 x RJ-45 (LAN1: Intel I219LM; LAN2: Intel I211), wake on LAN supported
Status: Green: Link (On)/ Active (Flash)
Speed: Green: 100Mbps (On)/ 10Mbps (Off), Orange: 1000Mbps (On)
 - 1 x Power button with LED, 1 x WIFI LED, 1 x Storage LED, 2 x Antenna hole, 1 x Kensington Security Slot
- **Internal Expansion:**
 - 1 x full-size mini-PCIe, colay mSATA
 - 1 x standard SIM slot
- **Maximum Resolution:** 4096 x 2160 @60Hz by HDMI2.0/ DP1.2
- **Operating System:**
 - Microsoft Windows 7 (64bit/32bit), Windows 8.1 (64bit), Windows 10 (64bit)
 - Linux supported by project

1.4 Mechanical Specifications

1.4.1 Dimensions

200W x 118D x 30H mm (OPS compliant)

Unit:mm

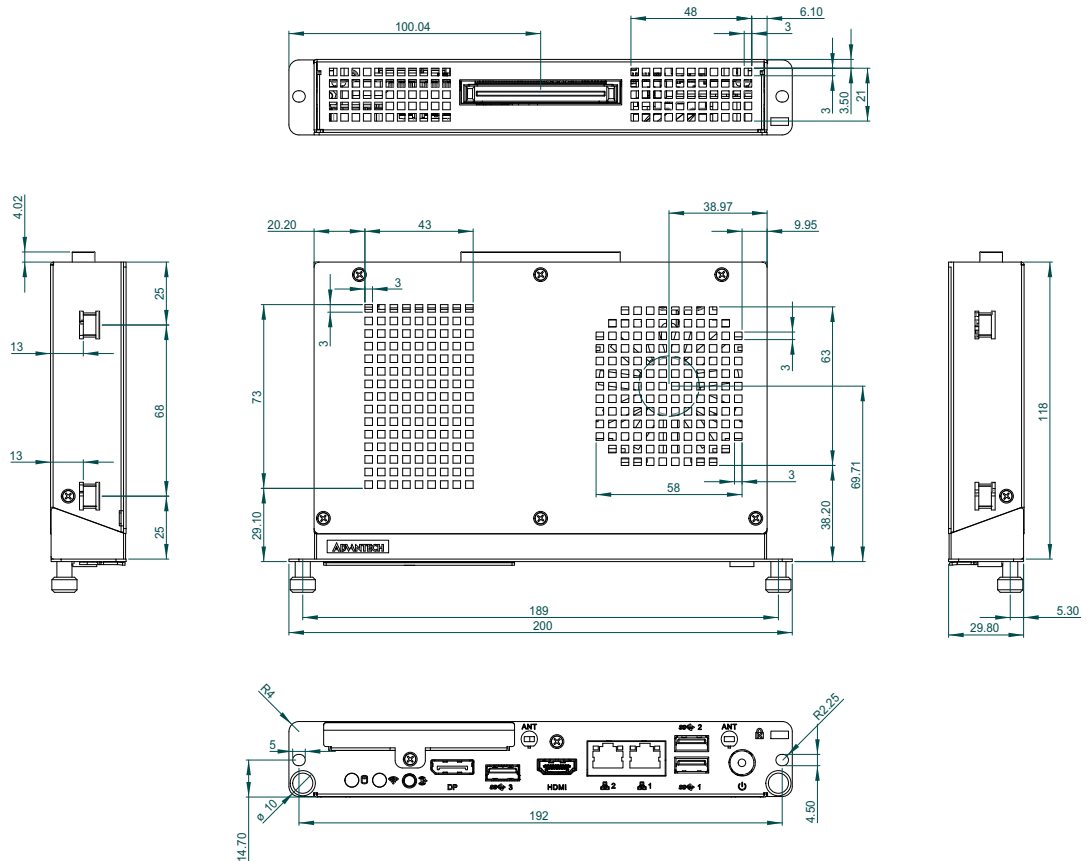

Figure 1.1 DS-280 Mechanical Dimensions (Unit: mm)

1.4.2 Weight

1.5 kg (3.3 lb)

1.5 Power Requirements

1.5.1 System Power:

Rating 12 ~ 19 V DC-in, 5-2.5A via OPS connector

Note! This product is intended to be supplied by a Listed Power Supply - rated at 12-19Vdc, 5-2.5A minimum



1.5.2 RTC Battery:

3 V/195 mAH BR2032

Caution! *There is a risk of explosion if the battery is replaced by an incorrect type. Always dispose of batteries in accordance with safety instructions.*



1.6 Environmental Specifications

1.6.1 Operating Temperature

0° C - 40° C (32~104° F) w/ HDD ; 0° C - 50° C (32~122° F) w/ SSD

1.6.2 Relative Humidity

95% @ 40 °C (non-condensing)

1.6.3 Storage Temperature

-20 ~ 70 °C (-4 ~ 158 °F)

1.6.4 Vibration Loading During Operation (HDD)

0.2 Grms, IEC 60068-2-64, random, 5 ~ 500 Hz, 1 Oct./min, 1 hr/axis.

1.6.5 Safety

UL, CB, CCC

1.6.6 EMC

CE, FCC Class B, BSMI, CCC

Chapter 2

I/O Connectors

This chapter introduces external I/O of DS-280 Hardware.

2.1 DS-280 I/O Connectors

2.1.1 Front I/O

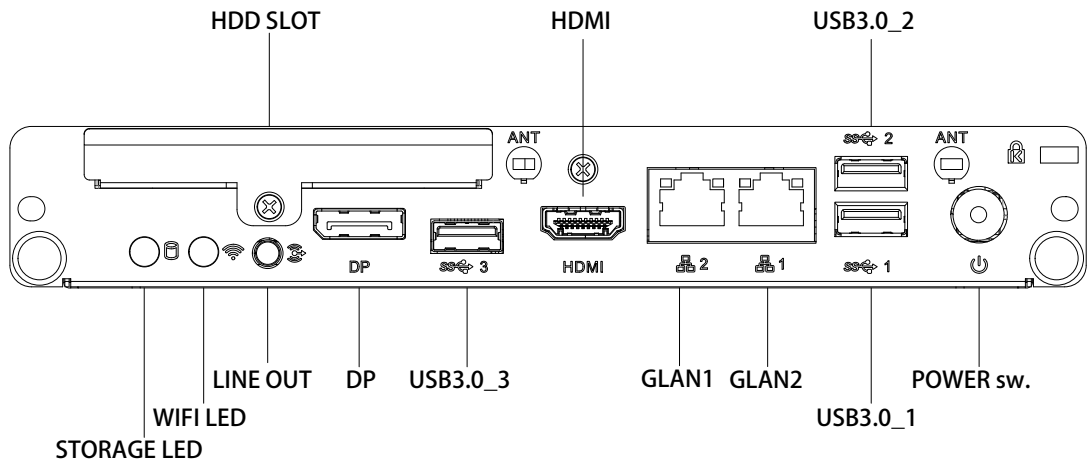

2.1.2 Rear I/O

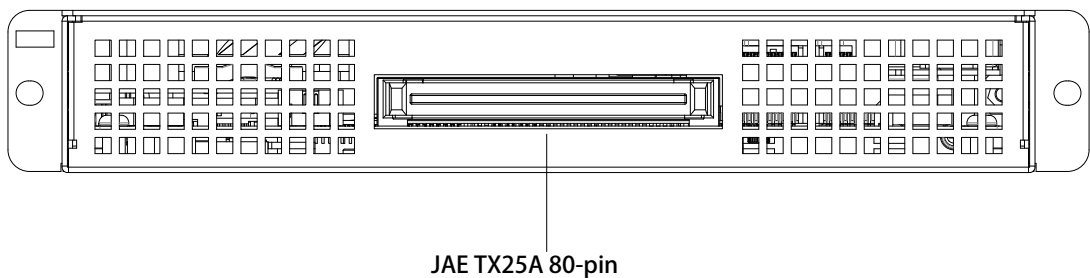

2.2 DS-280 External I/O Connectors

2.2.1 Power ON/OFF Button

DS-280 has a power ON/OFF button on the front side. Push this button to turn the system ON and OFF. It also supports a 4 second delay soft power off.



Figure 2.1 Power Button

2.2.2 USB3.0 Connectors

There are 3x USB3.0 interfaces which are compliant with USB UHCI, Rev. 3.0 and support Plug and Play. It is convenient to connect or disconnect a device without turning off the computer.

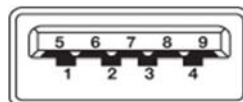

Figure 2.2 USB3.0 Connector

Table 2.1: USB3.0 Port Pin Assignments

Pin	Signal Name
1	VBUS
2	USB Data-
3	USB Data+
4	GND
5	StdA_SSRX-
6	StdA_SSRX+
7	GND_DRAIN
8	StdA_SSTX-
9	StdA_SSTX+

2.2.3 Ethernet Connector (LAN)

DS-280 provides 2x RJ-45 (LAN1: Intel I219LM, LAN2: Intel I211), and wake on LAN supported. They are fully compliant with IEEE 802.3u 10/100/1000 Base-T CSMA/CD standards. The Ethernet port provides a standard RJ-45 jack connector with LED indicators on the front side to show its Link(On)/ Active (Flash) and speed status which is with its green color by 100Mbps (On)/ 10Mbps (Off) and its orange color by 1000Mbps (On).

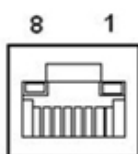
**Figure 2.3 GLAN Connector****Table 2.2: LAN Connector Pin Assignments**

Pin	Signal Name
1	MDI0+
2	MDI0-
3	MDI1+
4	MDI1-
5	GND
6	GND
7	MDI2+
8	MDI2-

2.2.4 Audio Connector

Line-Out: Stereo speakers, earphone or front surround speakers can be connected to the Line-out jack.

**Figure 2.4 Line-out connector**

2.2.5 HDMI2.0

DS-280 is designed for HDMI2.0 for 1pcs to communicate full video or sounds and follow HDCP. HDMI follow HDCP standard simultaneously.

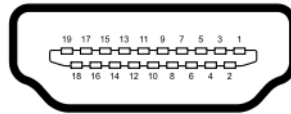

Figure 2.5 HDMI Connector

Table 2.3: HDMI Pin out

Pin	Signal Name
1	TMDS Data 2+
2	TMDS Data 2 shield
3	TMDS Data 2-
4	TMDS Data 1+
5	TMDS Data 1 shield
6	TMDS Data 1-
7	TMDS Data 0+
8	TMDS Data 0 shield
9	TTMDS Data 0-
10	TMDS Clock+
11	TMDS Clock shield
12	TMDS Clock-
13	CEC
14	Reserved
15	SCL
16	SDA
17	DDC/CEC Ground
18	+5V
19	Hot Plug Detect

2.2.6 DisplayPort1.2

DS-280 not only uses DisplayPort to achieve higher resolutions (4096x2304@60Hz) by low pin but also allows data packets to be extensible, meaning additional features can be added over time without significant changes to the physical interface itself.

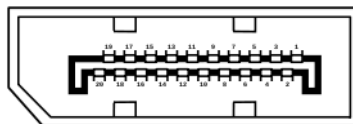

Figure 2.6 DisplayPort Connector

Table 2.4: DisplayPort Connector

Pin	Signal Name
1	ML_Lane 0 (p)
2	GND
3	ML_Lane 0 (n)
4	ML_Lane 1 (p)

Table 2.4: DisplayPort Connector

5	GND
6	ML_Lane1 (n)
7	ML_Lane2 (p)
8	GND
9	ML_Lane2 (n)
10	ML_Lane3 (p)
11	GND
12	ML_Lane3 (n)
13	GND
14	GND
15	AUX_CH (p)
16	GND
17	AUX_CH (n)
18	Hot Plug
19	DP_PWR Return
20	DP_PWR

2.2.7 JAE TX-25A Connector

DS-280 supports HDMI/DP, UART (TxRx), 1x USB3.0, 2x USB2.0, Audio-out from JAE TX-25A 80-pin angle connector which plugs JAE TX-24A to a monitor. The maximum resolution also supports either HDMI1.4 4096x2160@24Hz or DP1.2 4096x2304@60Hz.

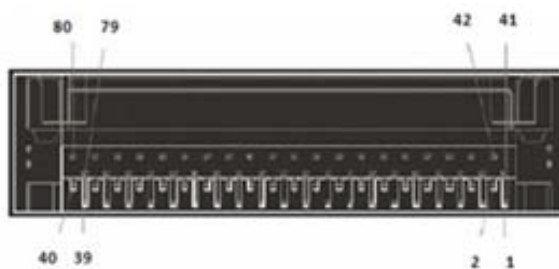
**Figure 2.7 JAE TX-25A 80-pin Connector****Table 2.5: JAE-TX-25A Pin out**

Pin	Signal Name	Pin	Signal Name
1	DDP_3N	41	RSVD
2	DDP_3P	42	RSVD
3	GND	43	RSVD
4	DDP_2N	44	RSVD
5	DDP_2P	45	RSVD
6	GND	46	RSVD
7	DDP_1N	47	RSVD
8	DDP_1P	48	RSVD
9	GND	49	RSVD
10	DDP_0N	50	SYS_FAN
11	DDP_0P	51	UART_RXD
12	GND	52	UART_TXD

Table 2.5: JAE-TX-25A Pin out

13	DDP_AUXN	53	GND
14	DDP_AUXP	54	StdA_SSRX-
15	DDP_HPD	55	StdA_SSRX+
16	GND	56	GND
17	TMD_CLK-	57	StdA_SSTX-
18	TMD_CLK+	58	StdA_SSTX+
19	GND	59	GND
20	TMDS0-	60	USB_PN2
21	TMDS0+	61	USB_PP2
22	GND	62	GND
23	TMDS1-	63	USB_PN1
24	TMDS1+	64	USB_PP1
25	GND	65	GND
26	TMDS2-	66	USB_PN0
27	TMDS2+	67	USB_PP0
28	GND	68	GND
29	HDMI_DDC_DATA	69	AZ_LINEOUT_L
30	HDMI_DDC_CLK	70	AZ_LINEOUT_R
31	HDMI_HPD	71	HDMI_CEC
32	GND	72	PB_
33	+12V~+24V	73	PS_ON#
34	+12V~+24V	74	PWR_STATUS
35	+12V~+24V	75	GND
36	+12V~+24V	76	GND
37	+12V~+24V	77	GND
38	+12V~+24V	78	GND
39	+12V~+24V	79	GND
40	+12V~+24V	80	GND

Chapter 3

Hardware Installation

This chapter introduces the installation of DS-280 Hardware.

3.1 Hardware Installation

3.1.1 Installation Ways for Displays

There are three ways to have slot-in DS-280 behind the displays as below. Please make sure DS-280 is fixed well before boot up. (These slot-in ways depend on display design.)

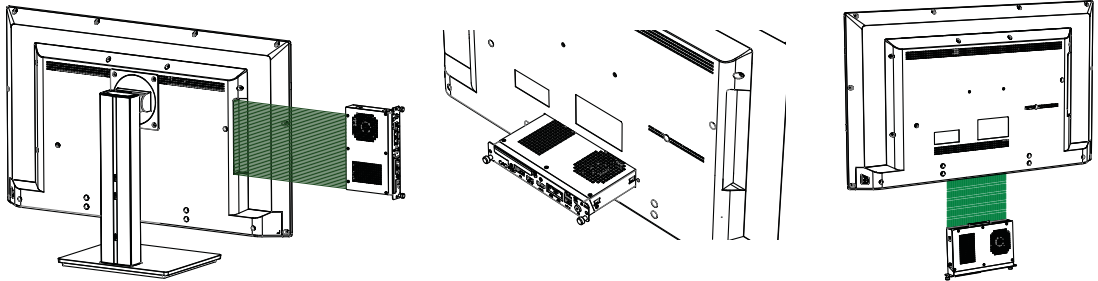

3.1.2 Storage Installation

1. To assemble the storage module, secure the HDD to HDD bracket with 2 screws.
2. Undo the top storage screws and remove.
3. Install the storage module into DS-280 as below, and connect the storage and SATA connector onto the device.
4. Lastly, fix the storage module onto DS-280 via a screw.

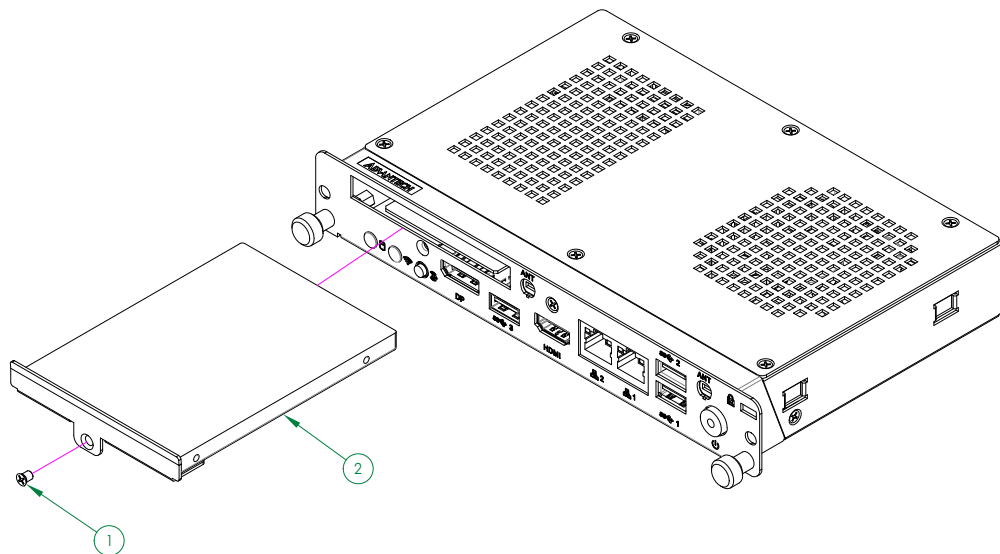

Figure 3.1 HDD Installation

3.1.3 Memory 1 Installation

1. Remove 6 screws from DS-280 top case and carefully take it away to avoid the fan cable damaging.
2. Undo the top storage screws and remove.
3. Install memory into the SO-DIMM1 slot.
4. Lastly, follow the below steps and install the whole system.

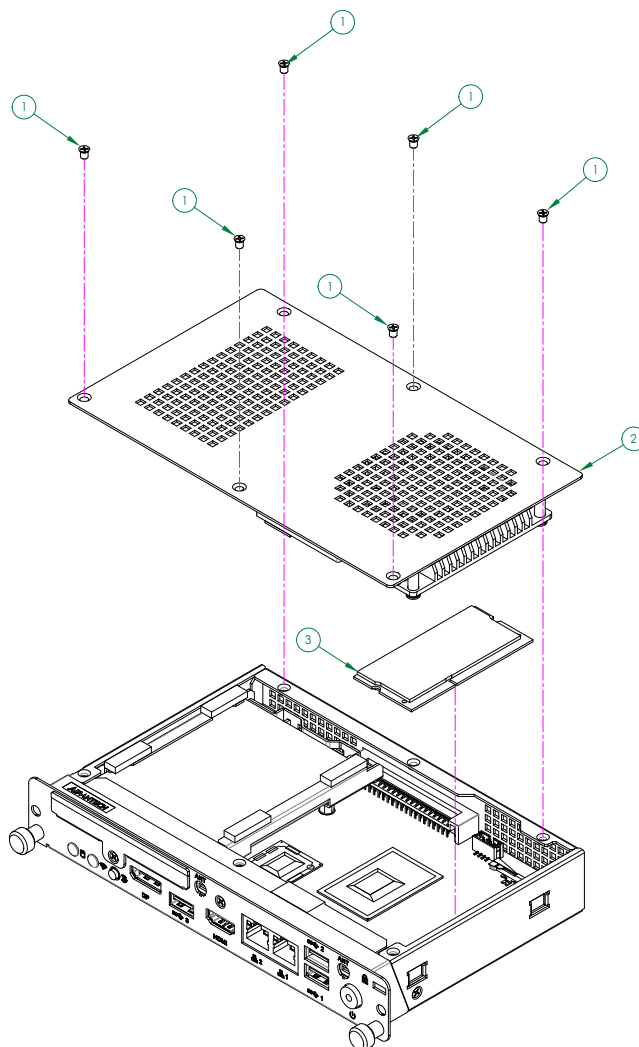

Figure 3.2 Memory 1 Installation

3.1.4 Memory 2 Installation

1. Remove 1 screw on the right cover of DS-280 bottom case.
2. Install memory into the SO-DIMM 2 slot.
3. Lastly, follow the steps to install the whole system.

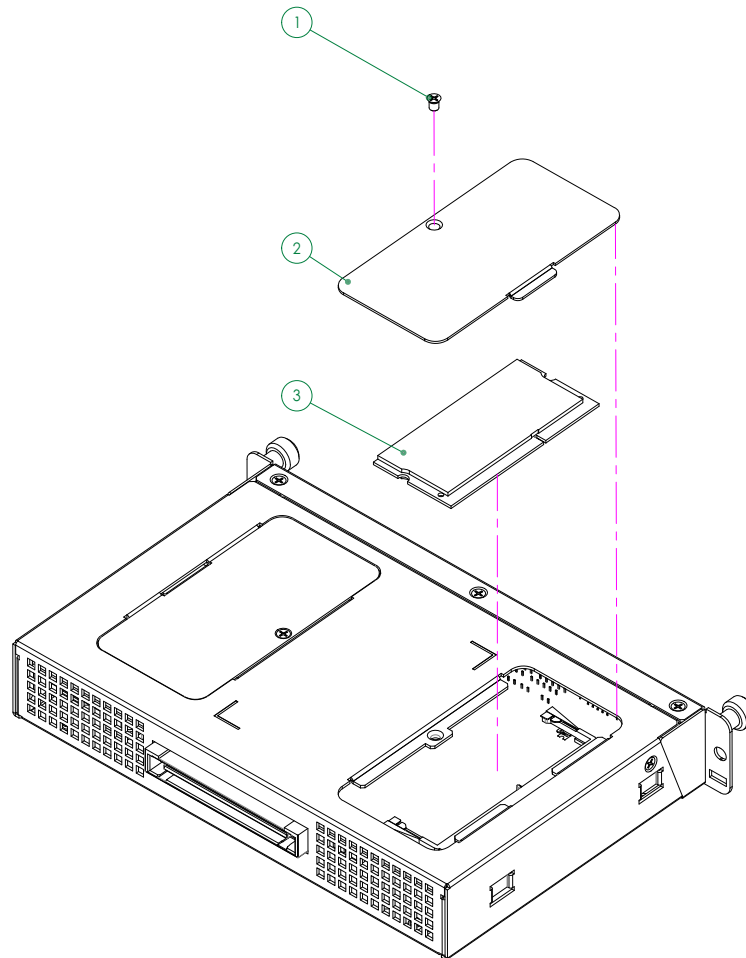

Figure 3.3 Memory 2 Installation

3.1.5 mini-PCle & SIM card installation

1. Remove 1 screw from the left cover of DS-280 bottom case.
2. Install mini-PCle card into mini-PCle slot or SIM card into SIM slot.
3. Lastly, follow the steps below and install the whole system.

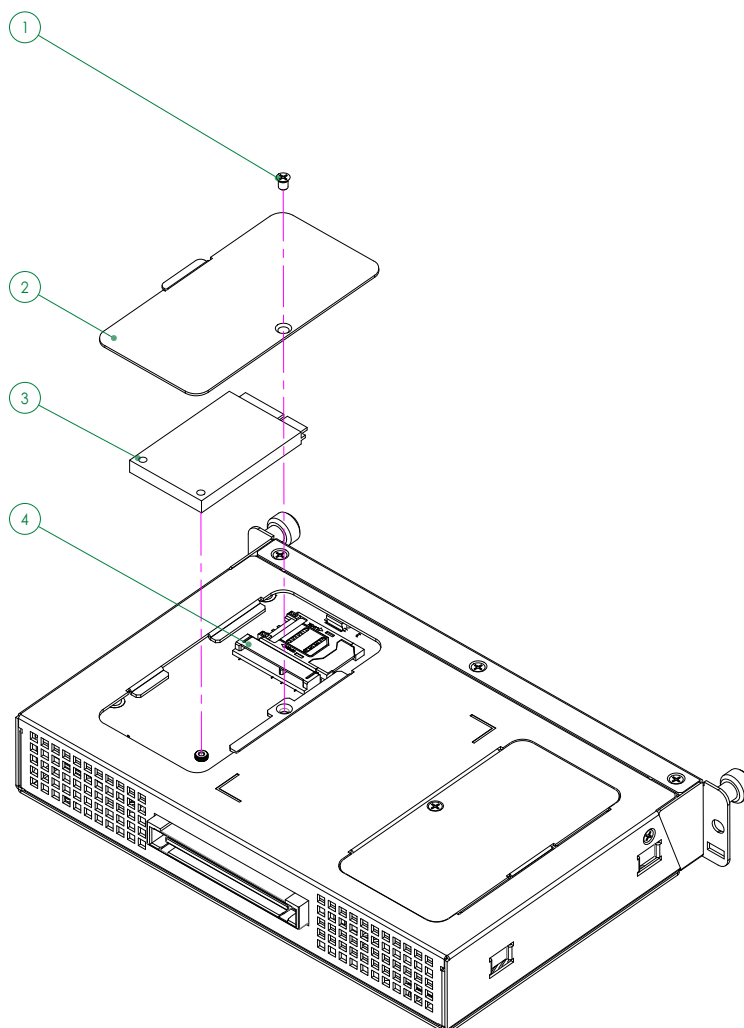

Figure 3.4 mini-PCle/ SIM card Installation

3.1.6 Antenna Installation (Optional)

1. Remove 6 screws from DS-280 top case and carefully take it away to avoid the fan cable damaging.
2. Undo 1 screw from the front storage slot and take storage tray away.
3. Undo 4 screws from the front panel and gently take the whole front panel away.
4. Clean the antenna holes which you want to use and fix the WIFI cable on them by rubbers, nuts, and six-angle screws.
5. After completed it, please return the whole front panel, top case, storage tray and bracket by tightening all the screws. Then, to make sure all the screws are fixed.
6. Install the external antennas and ensure to properly tighten them.

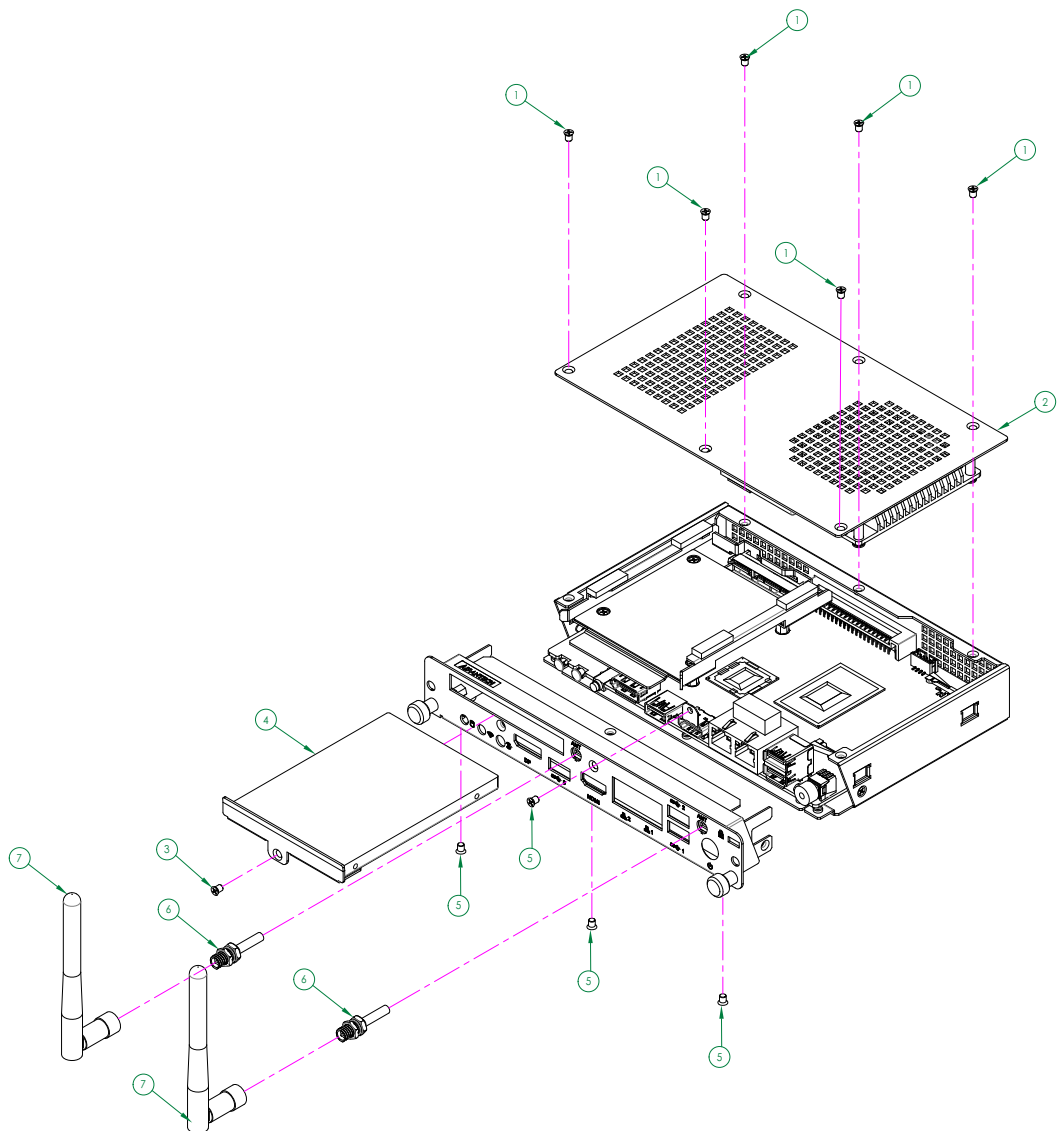

Figure 3.5 Antenna Installation (Optional)

Chapter 4

BIOS Settings

This chapter introduces how to set BIOS configuration data.

4.1 BIOS Introduction

AMI BIOS has been integrated into many motherboards for over two decades. With the AMI BIOS Setup program, you can modify BIOS settings and control various system features. This chapter describes the basic navigation of the DS-280 series BIOS setup screens.

AMI BIOS's ROM has a built-in setup program that allows users to modify the basic system configuration. This information is stored in flash part CMOS so it retains the setup information when the power is turned off.

There are some different settings with 6th Gen Intel processor compared with the previous platform, so please notice these following procedures of DS-280 BIOS.

4.2 Entering Setup

4.2.1 Main Setup

When you first enter the BIOS Setup Utility, you will enter the Main setup screen. You can always return to the Main setup screen by selecting the Main tab.

The Main BIOS setup screen has two main frames. The left frame displays all the options that can be configured. Options in blue can be configured, and grayed-out options cannot be configured instead. The right frame displays the key legend.

The key legend in the top is an area reserved for a text message. When an option is selected in the left frame, it is highlighted in white. Often a text message will accompany it.

You can use main setup to check BIOS related information and DS-280 hardware settings, such as project version, build date and time, power type, total memory, memory frequency, ME FW version, and system date/ time.

In this screen, only system date and time can be adjusted if you wanted. Highlight System Time or System Date using the <Arrow> keys. Enter new values through the keyboard. Press the <Tab> key or the <Arrow> keys to move between fields. The date must be entered in MM/DD/YY format. The time must be entered in HH:MM:SS format.



Figure 4.1 Main setup

4.2.2 Advanced Features Setup

Select the Advanced tab from the DS-280 setup screen to enter the Advanced BIOS setup screen. You can select any of the items in the left frame of the screen, such as CPU configuration, to go to the sub menu for that item. You can display an Advanced BIOS Setup option by highlighting it using the <Arrow> keys. All Advanced BIOS Setup options are described in this section. The Advanced BIOS Setup screens are shown below. The sub-menus are described on the following pages.

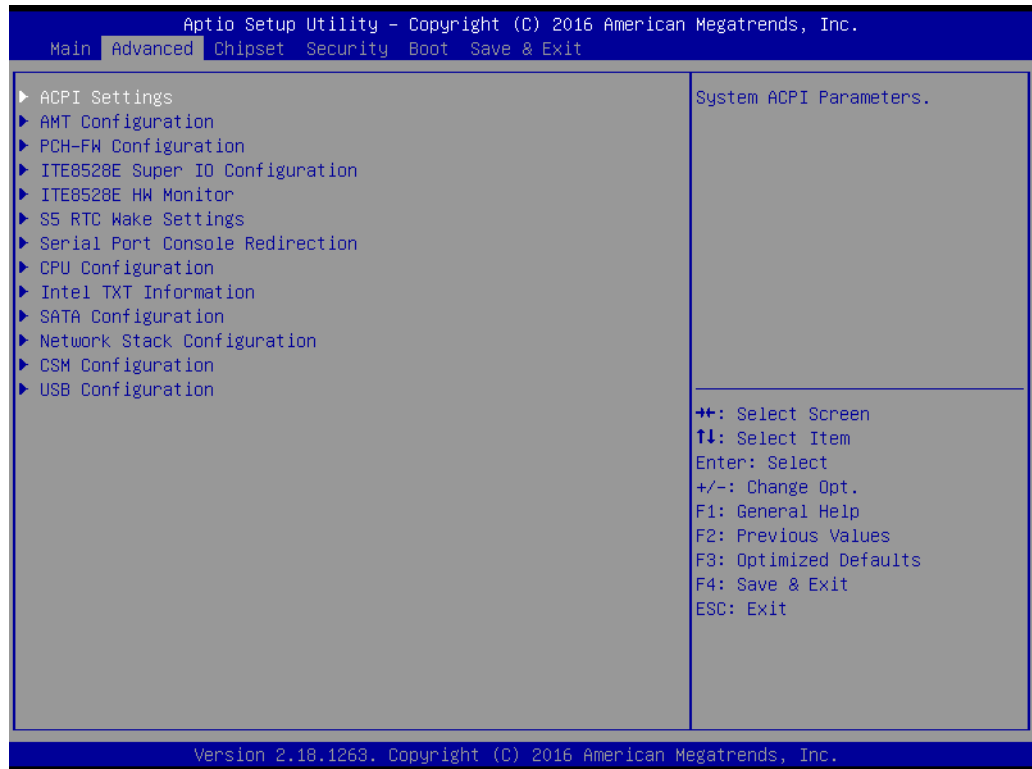

Figure 4.2 Advanced Features setup

4.2.2.1 ACPI Settings

ACPI is a subsystem which controls hardware states (thermal control, motherboard configuration, power states like sleep and suspend, and functions that may have previously been in the BIOS configuration).

If want to change ACPI sleep state, you can select the highest ACPI sleep state the system will enter the SUSPEND button is pressed. Configuration options: [Suspend Disable][S3 (suspend to RAM)].



Figure 4.3 ACPI setup

4.2.2.2 AMT Configuration

Intel® AMT includes hardware-based remote management, security, power management, and remote configuration features that enable independent remote access to AMT-enabled PCs. Intel® AMT is security and management technology that is built into PCs with Intel® vPro technology. DS-280 doesn't verify Intel® vPro function because of vPro certification but work on AMT function.

Configuration AMT Parameters:

- **Intel® AMT [Enabled]:**
Enabled/ Disabled AMT; Configuration options: [Disabled][Enabled].
- **BIOS Hotkey Pressed [Disabled]:**
Enabled/ Disabled BIOS hotkey pressed; Configuration options: [Disabled][Enabled].
- **MEBx Selection Screen [Disabled]:**
Enabled/ Disabled MEBx selection screen; Configuration options: [Disabled][Enabled].
- **Hide Un-Configure ME Confirmation Prompt [Disabled]:**
Hide Un-configure ME without password configuration prompt; Configuration options: [Disabled][Enabled].
- **MEBx Debug Message Output [Disabled]:**

Enabled/ Disabled MEBx debug message output; Configuration options: [Disabled][Enabled].

- **Un-Configure ME [Disabled]:**
Un-Configure ME without password; Configuration options: [Disabled][Enabled].
- **AMT Wait timer [0]:**
Set timer to wait before sending ASF_GET_BOOT_OPTION.
- **ASF [Enabled]:**
Enabled/ Disabled alert specification format; Configuration options: [Disabled][Enabled].
- **Active Remote Assistance Process [Disabled]:**
Trigger CIRA boot; Configuration options: [Disabled][Enabled].
- **USB Provisioning of AMT [Enabled]:**
Enabled/ Disabled USB provisioning of AMT; Configuration options: [Disabled][Enabled].
- **PET [Enabled]:**
User can Enabled/ Disabled PET Events progress to receive PET events or not; Configuration options: [Disabled][Enabled].
- **AMT CIRA Timeout [0].**
- **WatchDog Timer [Disabled]:**
Enabled/ Disabled WatchDog Timer; Configuration options: [Disabled][Enabled]. When [Enabled], OS and BIOS WatchDog Timers can be set.

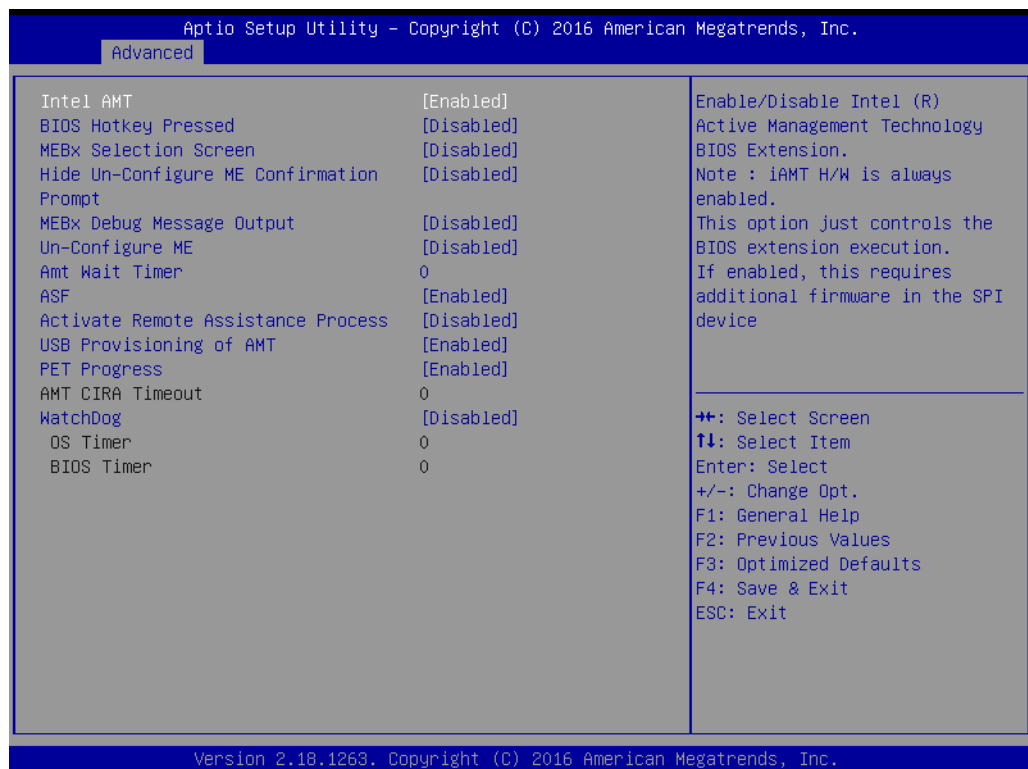

Figure 4.4 AMT configuration setup

4.2.2.3 PCH-FW Configuration

Configuration Management Engine Technology Parameter.

■ ME Firmware Information

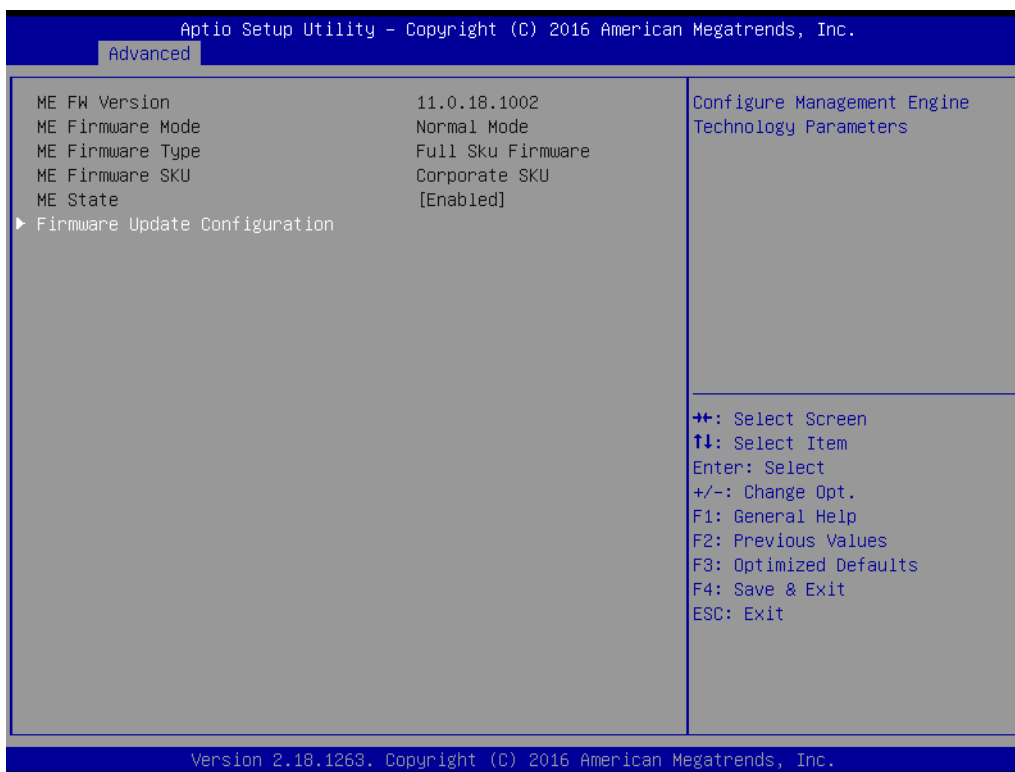

Figure 4.5 ME Firmware Information

■ ME Firmware Update Configuration

Enabled/ Disabled ME FW image Re-Flash function: Configuration options: [Disable][Enhanced].

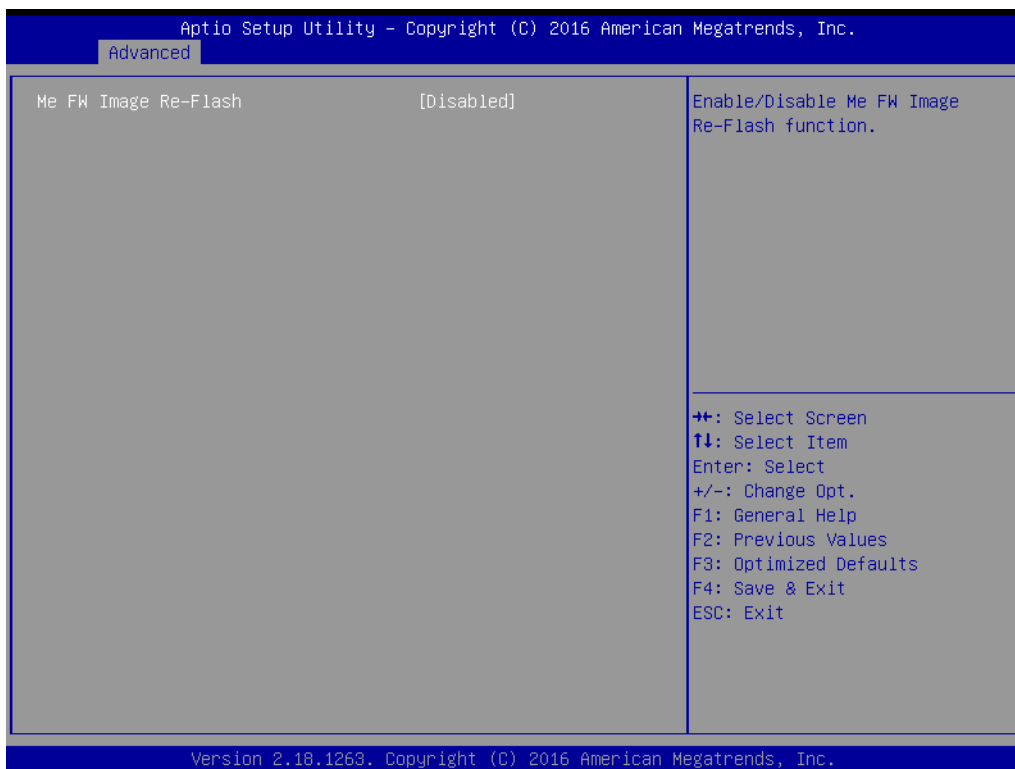

Figure 4.6 ME Firmware Update configuration setup

4.2.2.4 ITE8528E Super IO Configuration

System Super IO Chip Parameters.

■ Super IO Configuration: Super IO Chip [ITE8528E].

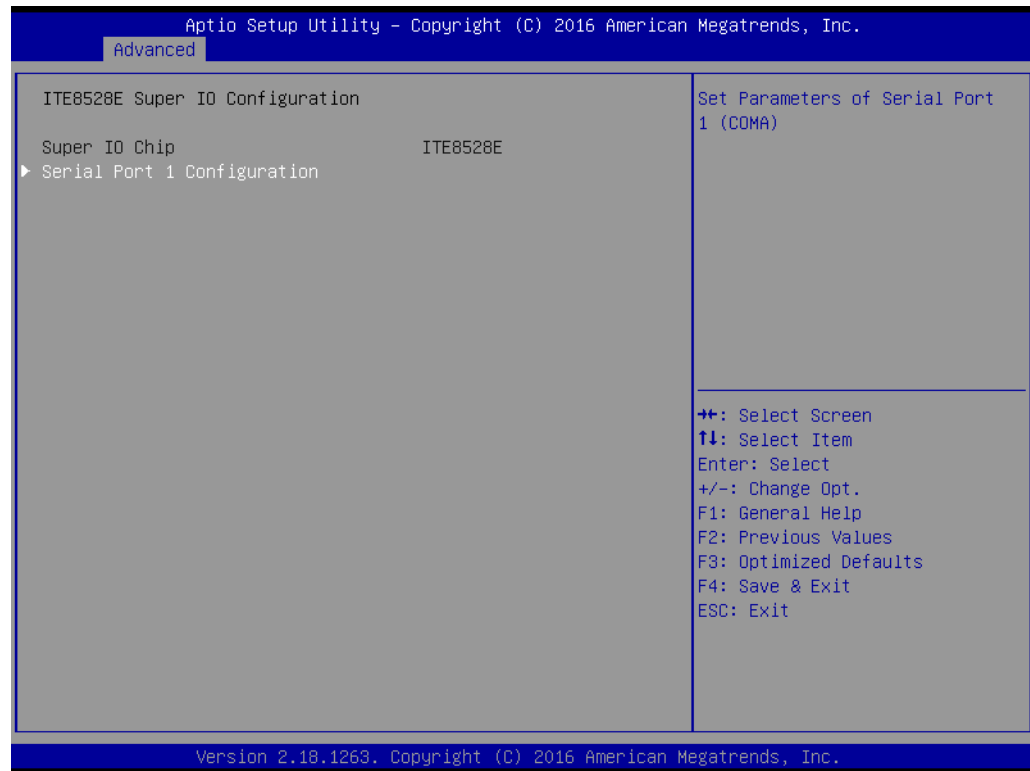

Figure 4.7 ITE8528E super IO configuration screen

- **Serial Port 1 Configuration:**
Set Parameters of Serial Port 1.
- **Serial Port [Enabled]:**
Enabled/ Disabled Serial Port; Configuration options: [Disabled][Enabled].
- **Device Setting [IO=3F8h; IRQ=4].**
- **Change Setting [Auto]:**
Select an optimal setting for Super IO device.

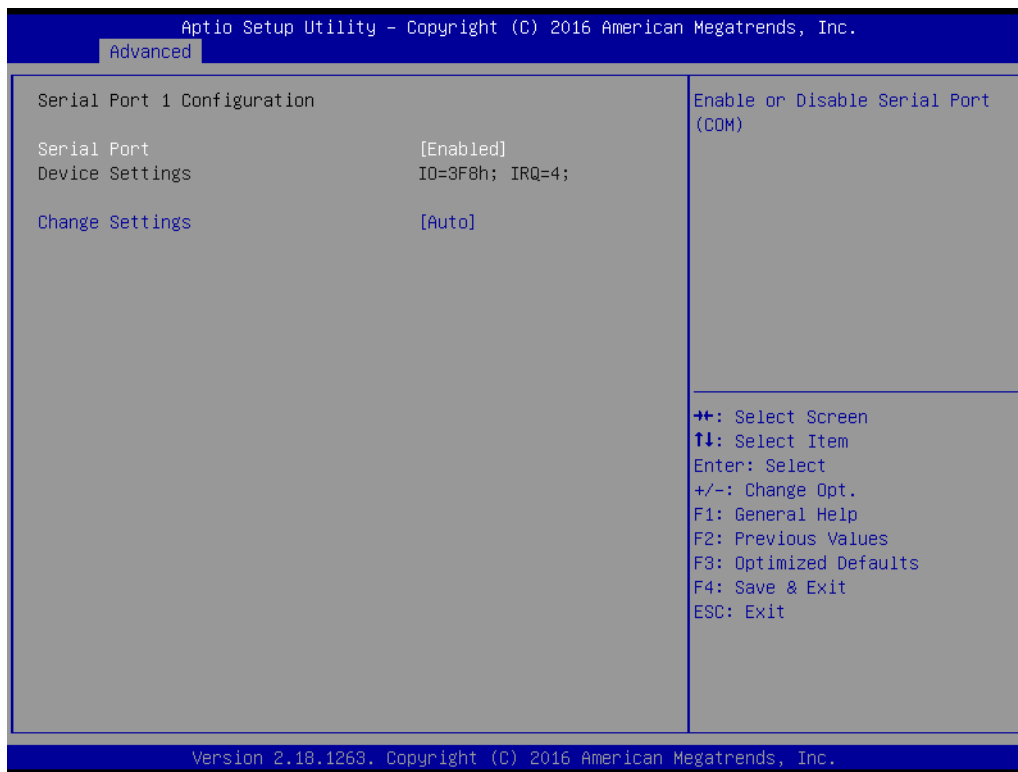

Figure 4.8 Serial Port 1 configuration setup

4.2.2.5 ITE8528E HW Monitor

- **Monitor hardware status (PC health status):**
Display system health status.



Figure 4.9 ITE8528E HW Monitor status

- **WatchDog Timer [Disabled]:**
Enabled/ Disabled WatchDog Timer; When [Enabled], you can change Watch-Dog Timer Mode is based on [Second] and Time out Value [30] you want.

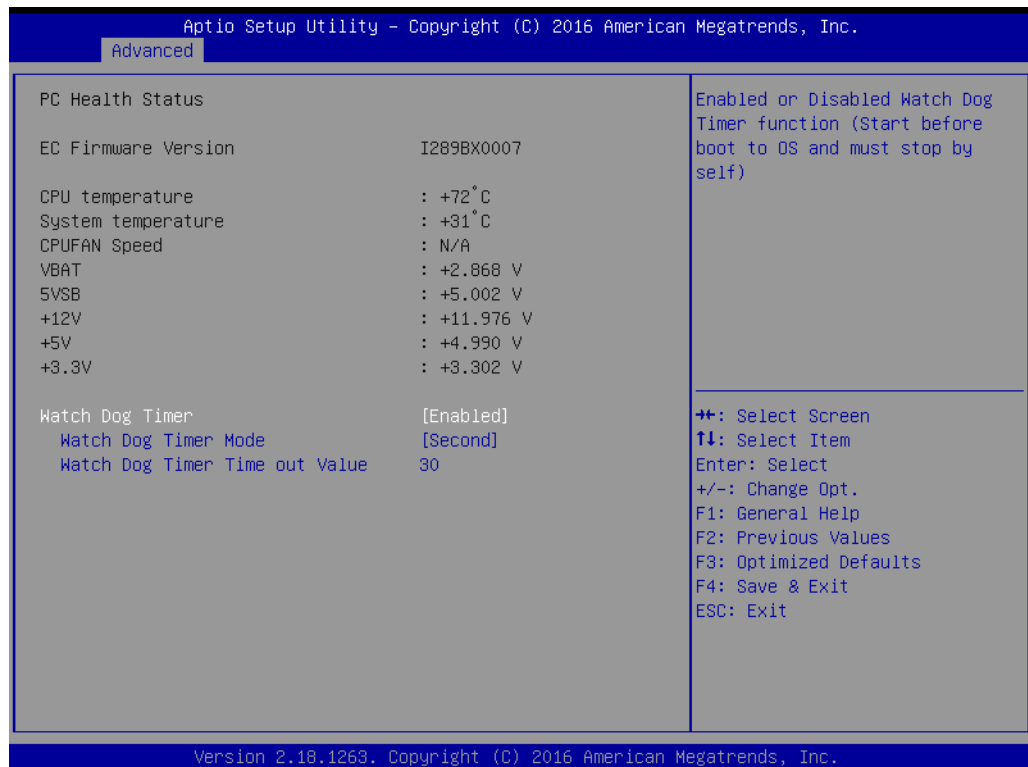

Figure 4.10 Watchdog Timer setup

4.2.2.6 S5 RTC wake setting

- Enable system to wake from S5 using RTC alarm.



Figure 4.11 S5 RTC wake screen

- **Wake system from S5 [Disabled]:**
Enabled/ Disabled Wake system from S5; Configuration options [Disabled][Enabled] and set up Wake up by day/ hour/ minute/ second [0] you want.

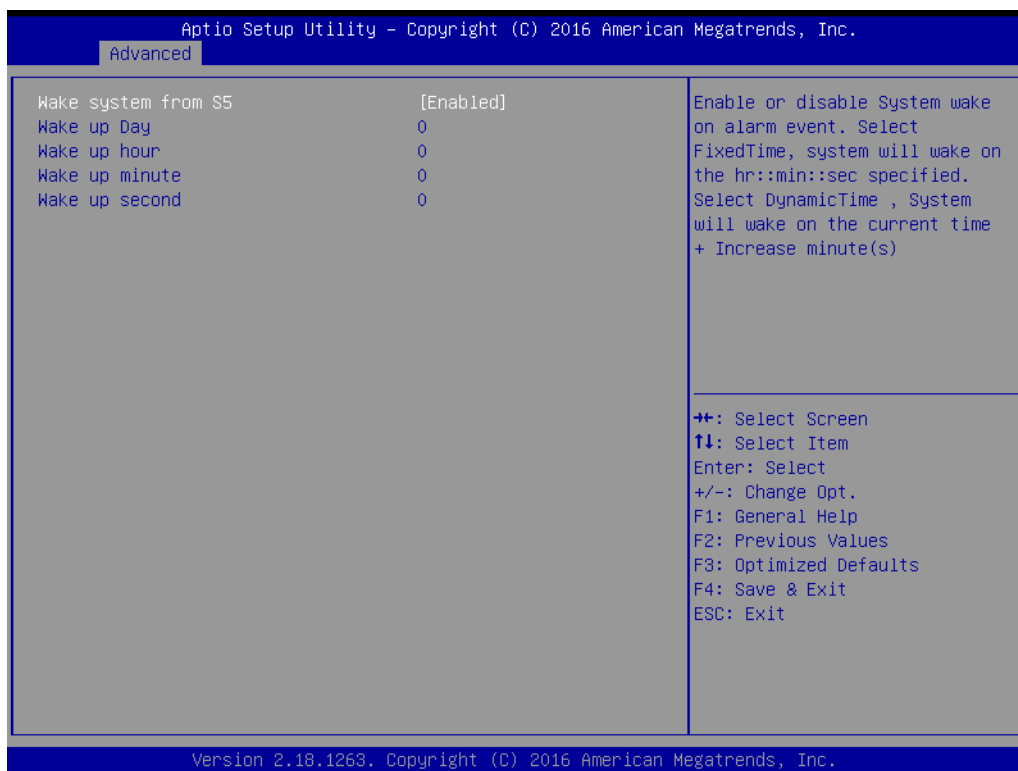

Figure 4.12 S5 RTC wake enabled setup

4.2.2.7 Serial port console redirection

Display COM console information.

- **COM1 – Console Redirection [Disabled]:**
Enabled/ Disabled COM1 – Console Redirection; Configuration options: [Disabled][Enabled].
- **Serial Port for Out-of-Band Management [Disabled]:**
Microsoft Windows Emergency Management Services (EMS) allows for remote management of a Windows Server OS through a serial port.

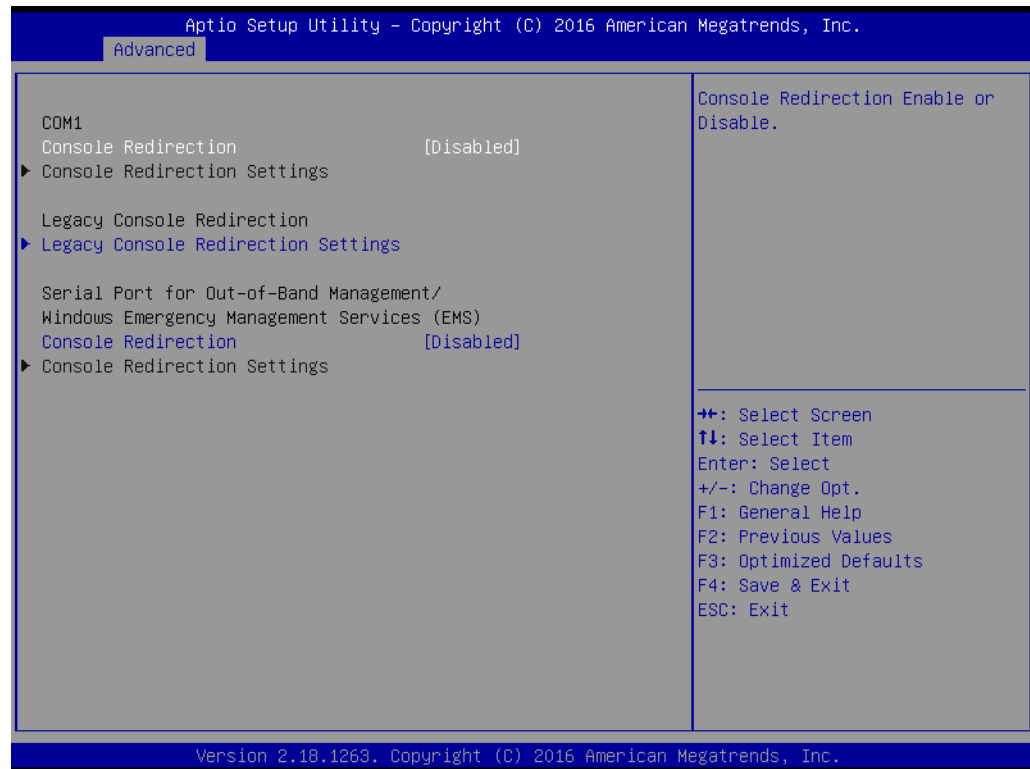

Figure 4.13 Serial port console redirection setup

- **Emulation:**
[ANSI] Extended ASCII Char set.
- **VT100:**
ASCII char set.
- **VT100+:**
Extends VT100 to support color, functional keys, etc.
- **VT-UTF8:**
Uses UTF8 encoding to map Unicode chars onto 1 or more bytes.

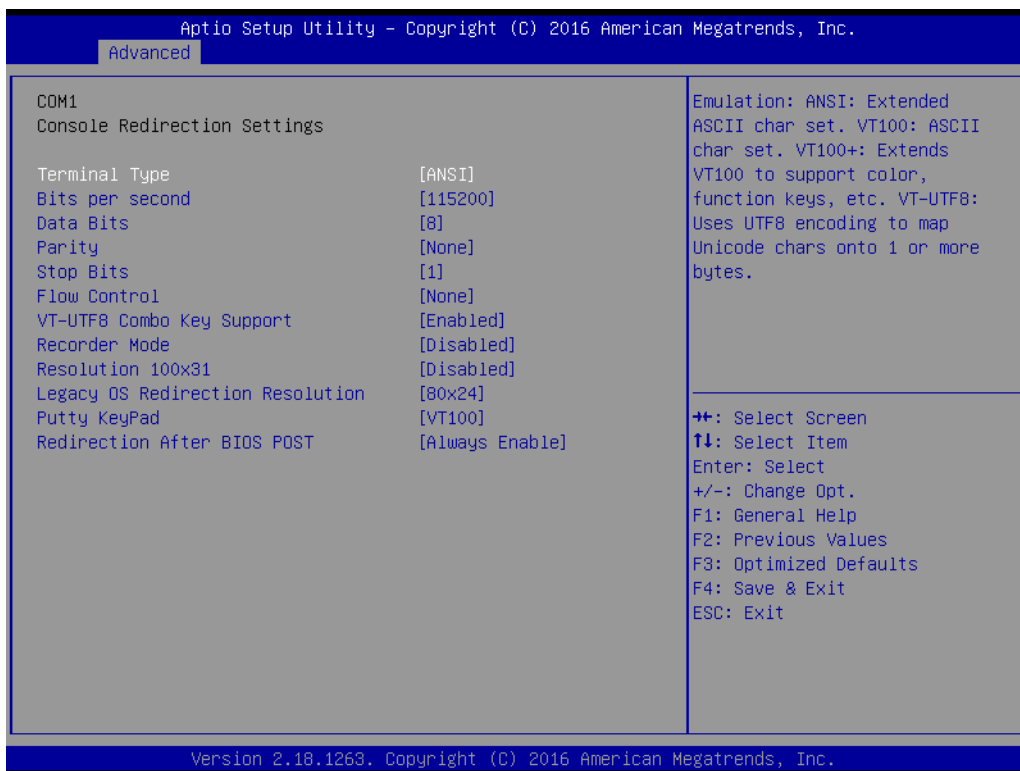

Figure 4.14 Console redirection setup

Select a COM port to display redirection of Legacy OS and Legacy OPRM Messages.



Figure 4.15 Legacy console redirection setup

Microsoft Windows Emergency Management Services (EMS) allows for remote management of a Windows Server OS through a serial port.

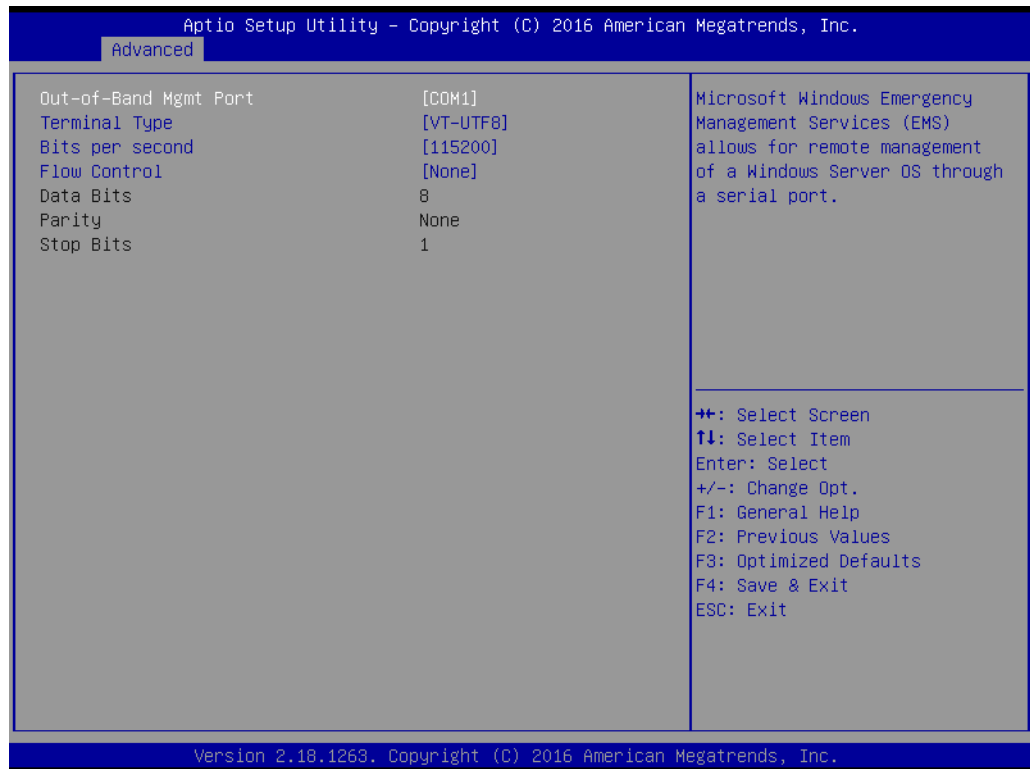

Figure 4.16 Console redirection settings

4.2.2.8 CPU Configuration

Displays CPU Configuration Parameters:

- **Hyper Threading Technology [Not Supported]**
- **Intel VT-x Technology [Supported]**
- **Intel SMX Technology [Supported]**
- **64-bit [Supported]**
- **EIST Technology [Supported]**
- **CPU C3 state [Supported]**
- **CPU C6 state [Supported]**
- **CPU C7 state [Supported]**
- **CPU C8 state [Supported]**
- **CPU C9 state [Supported]**
- **CPU C10 state [Supported]**

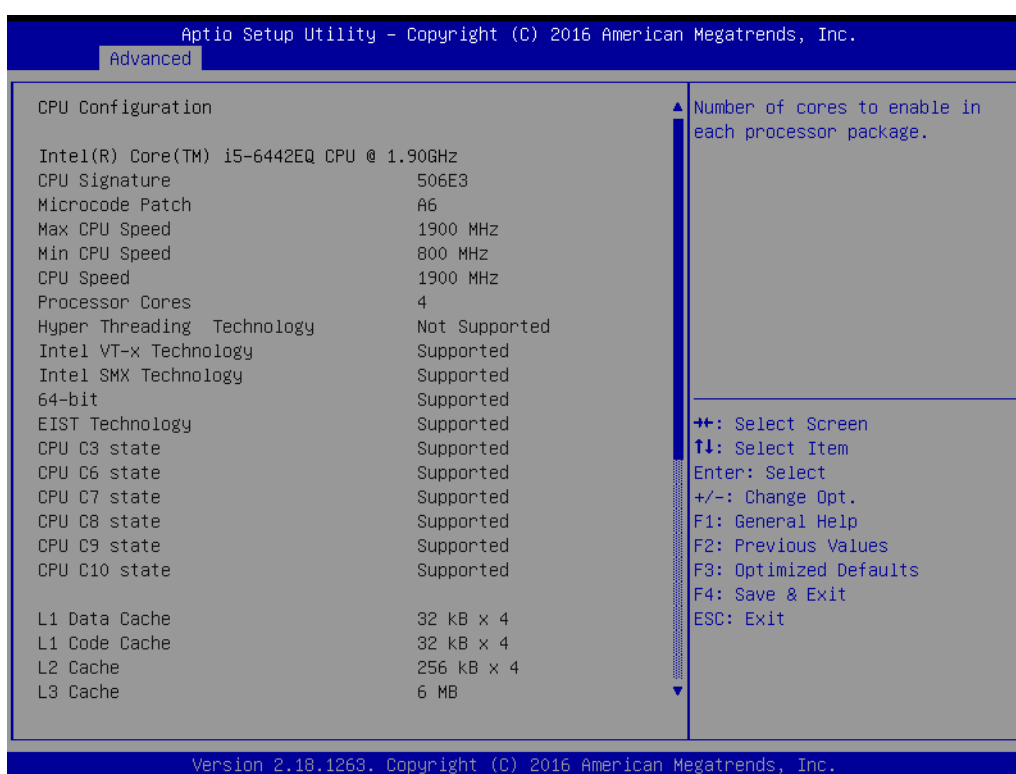

Figure 4.17 CPU configuration information

- **Active Processor Cores [All]:**
Select the numbers of cores in each processor package; Configuration options [All][1][2][3][4][5][6][7] which are subject to each processor type.
- **Intel Virtualization Technology [Enabled]:**
When enabled, a VMM can utilize the additional hardware capabilities provided by Vanderpool Technology; Configuration options: [Disabled][Enabled].
- **Hardware Prefetcher [Enabled]:**
To turn on/ off the Mid Level Cache (L2) steamer Prefetcher; Configuration options: [Disabled][Enabled].
- **Adjacent Cache Line Prefetch [Enabled]:**
To turn on/ off prefetching of adjacent cache lines; Configuration options: [Disabled][Enables].
- **Boot Performance Mode [Max Non-Turbo Performance]**

- Intel® Speed Shift Technology [Enabled]
- Intel® SpeedStep™ Turbo Mode [Enabled]
- CPU C States [Enabled]
- Package C State Limit [Auto]
- SW Guard Extensions (SGX) [Software Controlled]
- Select Owner EPOCH input type [No Change in Owner EPOCHs]

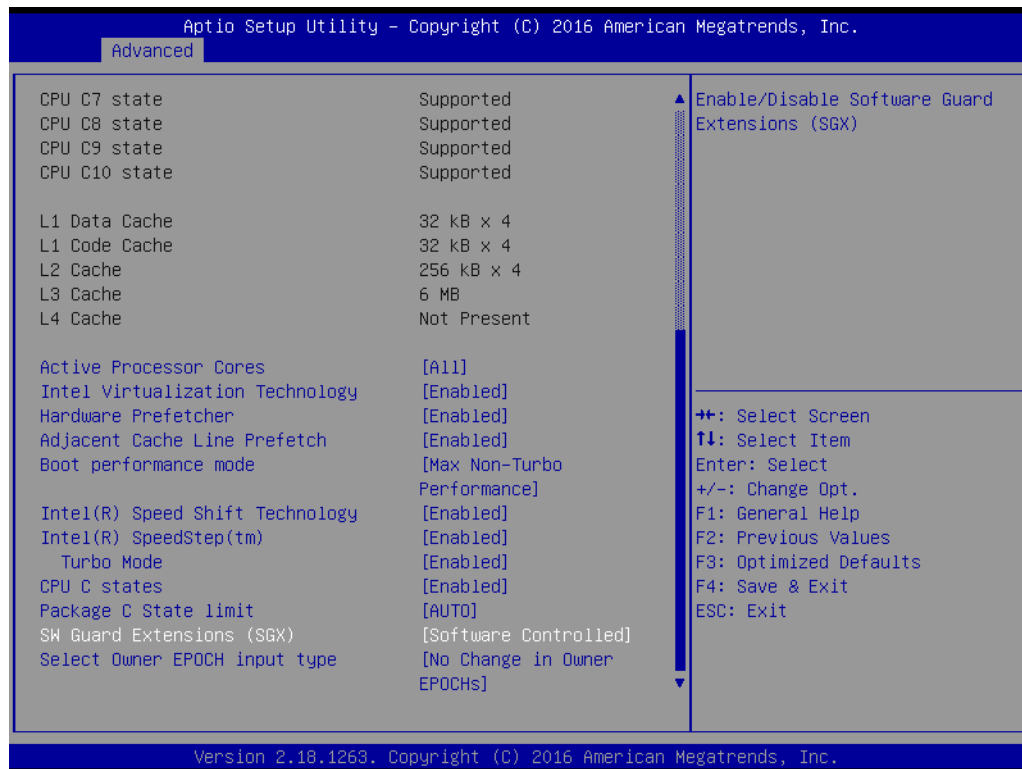

Figure 4.18 CPU configuration setup (continued)

4.2.2.9 Intel® TXT information

Display Intel® TXT Parameters.



Figure 4.19 Intel® TXT information

4.2.2.10 SATA configuration

- **SATA Mode [AHCI]:**
Support IDE, AHCI, or RAID mode; Configuration options: [Disabled][IDE][AHCI][RAID].
- **Serial ATA Port 1:**
Enabled/ Disabled SATA Device; Configuration options: [Disabled][Enabled]
- **mSATA:**
Enabled/ Disabled mSATA Device; Configuration options: [Disabled][Enabled]

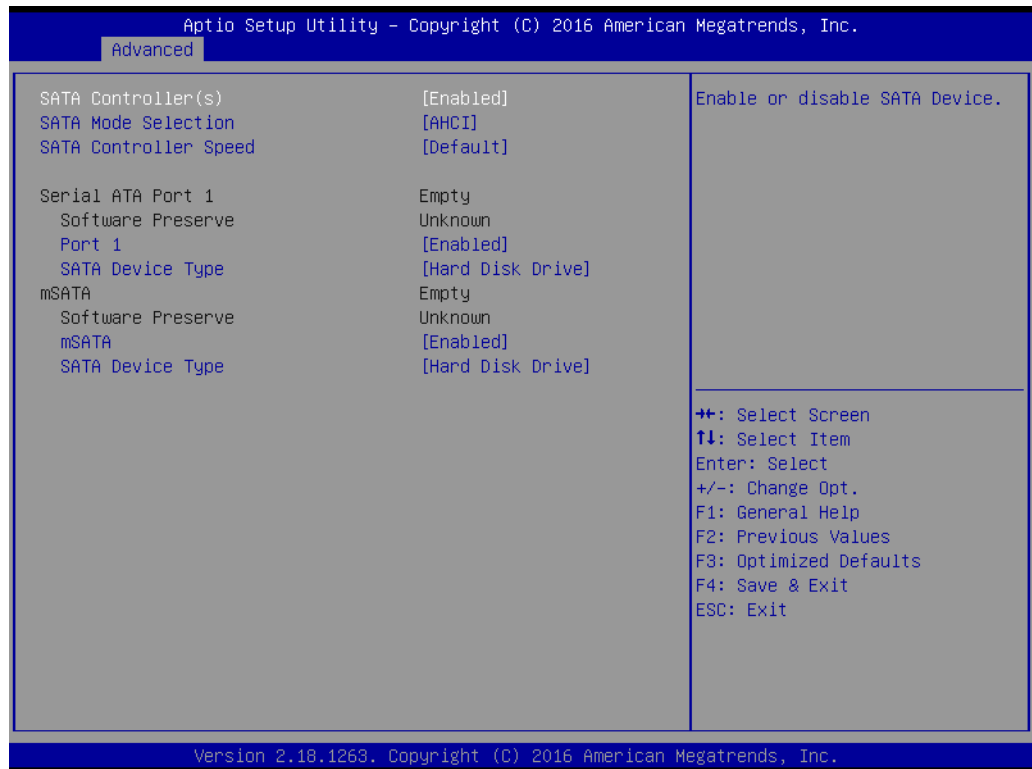

Figure 4.20 SATA configuration setup

4.2.2.11 Network Stack Configuration

Enabled/ Disabled UEFI Network Stack; Configuration options: [Disabled][Enabled].



Figure 4.21 Network Stack configuration disabled screen

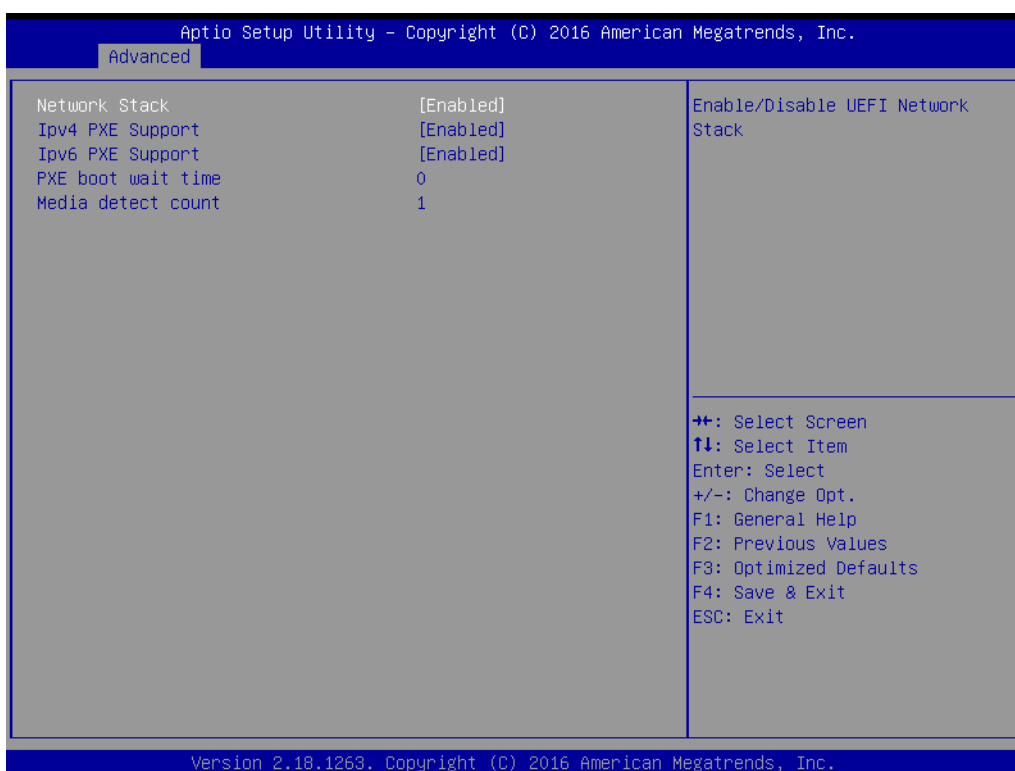

Figure 4.22 Network Stack configuration enabled setup

4.2.2.12 CSM configuration

Disabled/ Enabled CSM support; Configuration options: [Disabled][Enabled].

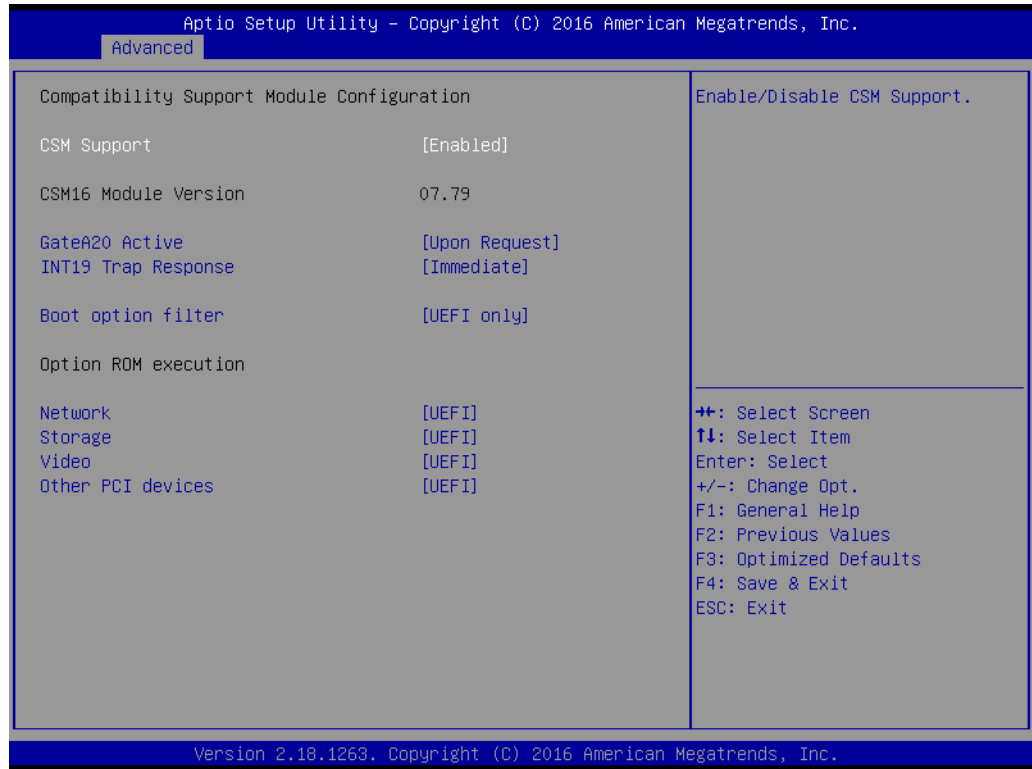

Figure 4.23 CSM configuration enabled setup

4.2.2.13 USB configuration

Disabled/ AUTO/ Disabled USB configuration; Configuration options: [Enabled][Disabled][AUTO].

- **[Enabled] Legacy USB support**
- **[AUTO] disables legacy support if no USB devices are connected.**
- **[Disabled] option will only for EFI application.**

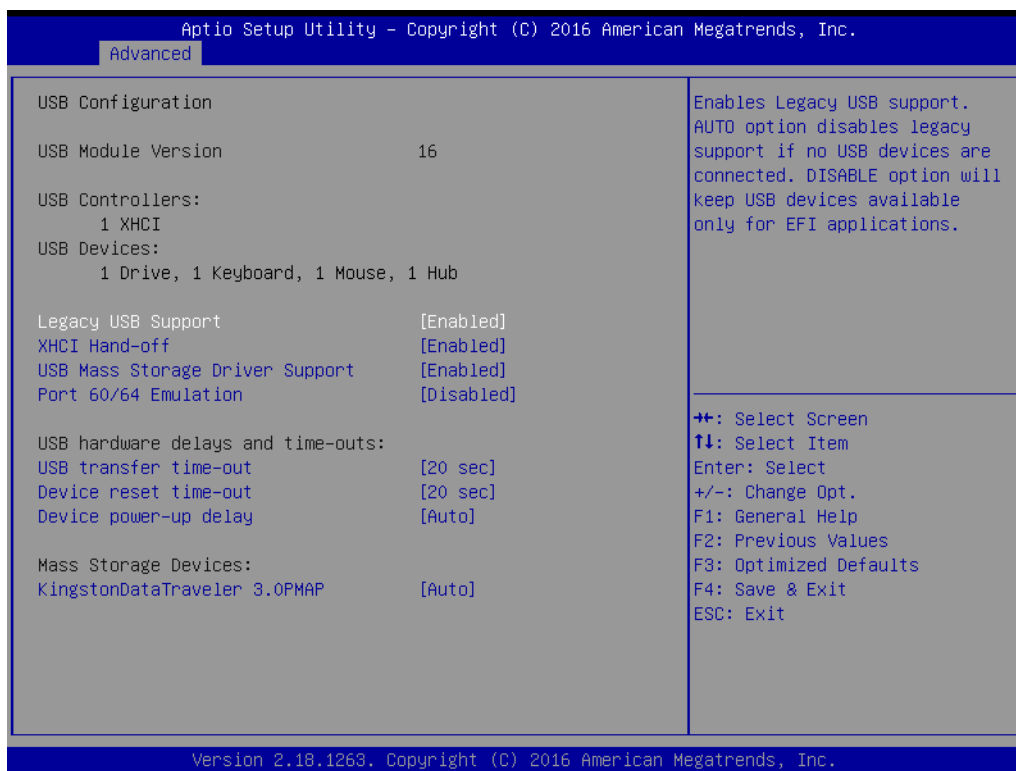

Figure 4.24 USB configuration setup

4.2.3 Chipset

Display System Agent (SA) Parameters.

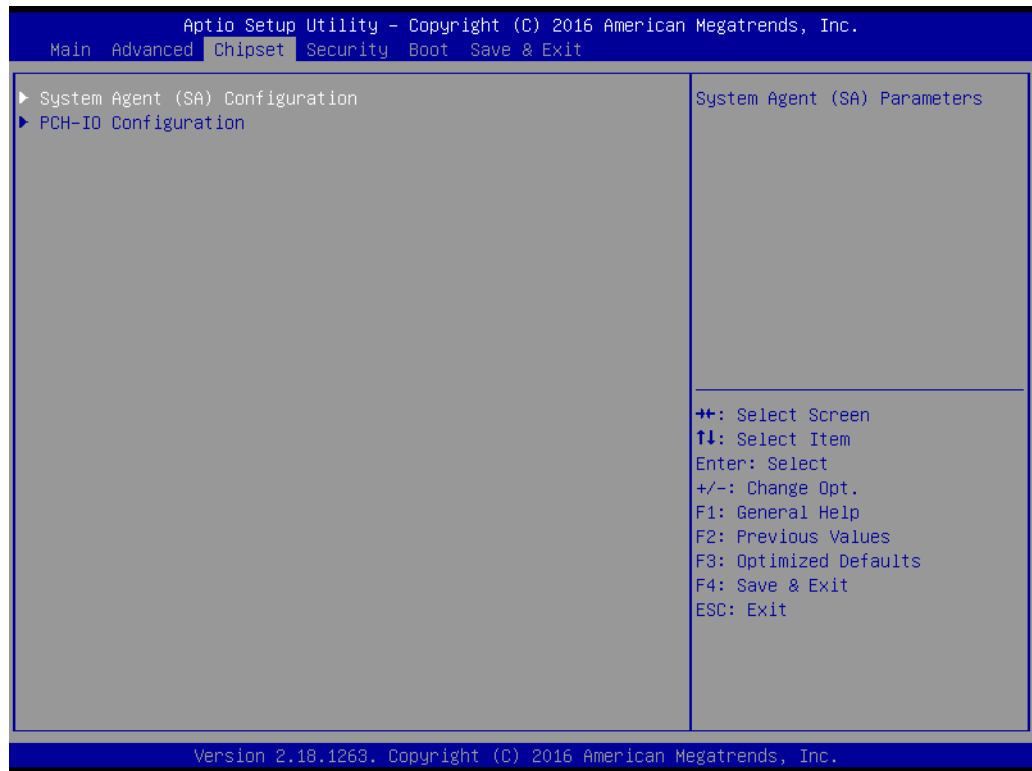

Figure 4.25 Chipset screen

4.2.3.1 System Agent

- **VT-d [Enabled]:**
Set VT-d Enabled/ Disabled; Configuration options: [Disabled][Enabled].
- **Graphics Configuration**
- **GT- Power Management Control**
- **Memory Configuration information.**

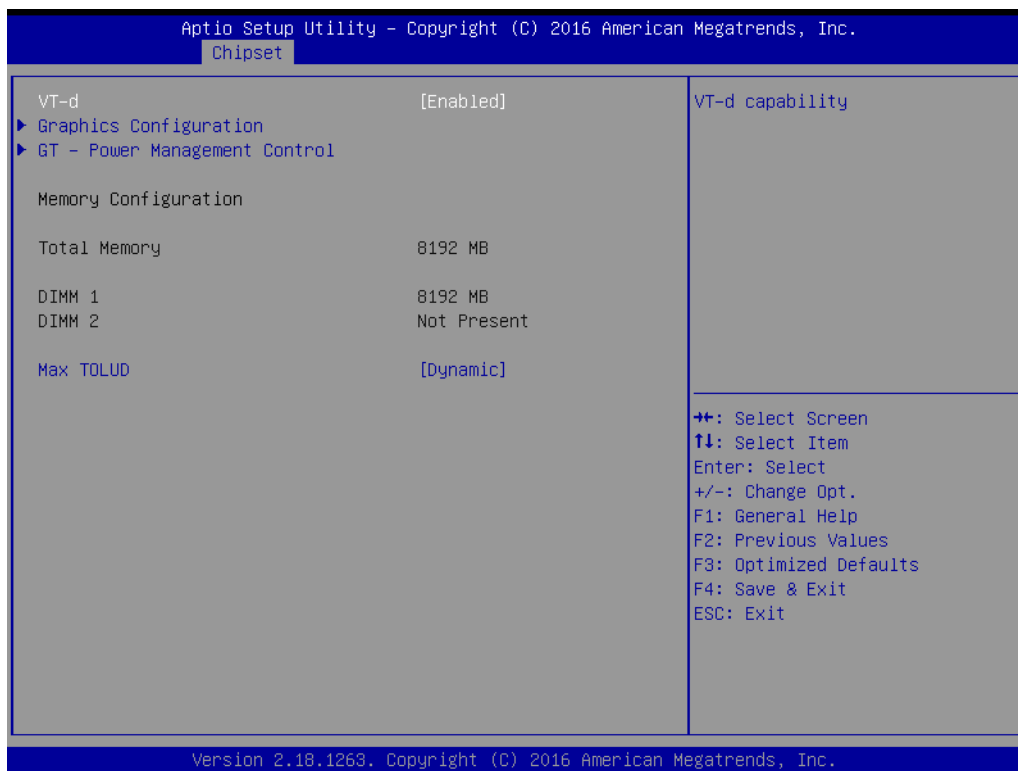

Figure 4.26 System Agent setup

■ **Graphic Configuration:**

Select the GTT size.

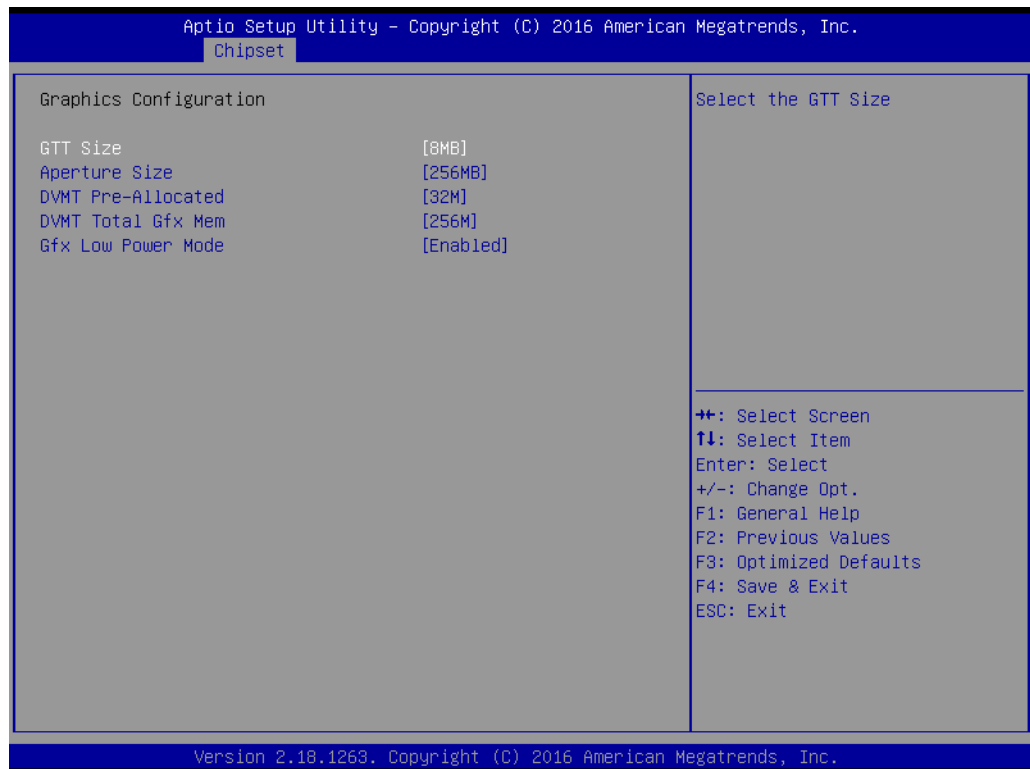

Figure 4.27 Graphic configuration setup

■ **GT-Power Management Control:**

Check to enable render standby support.

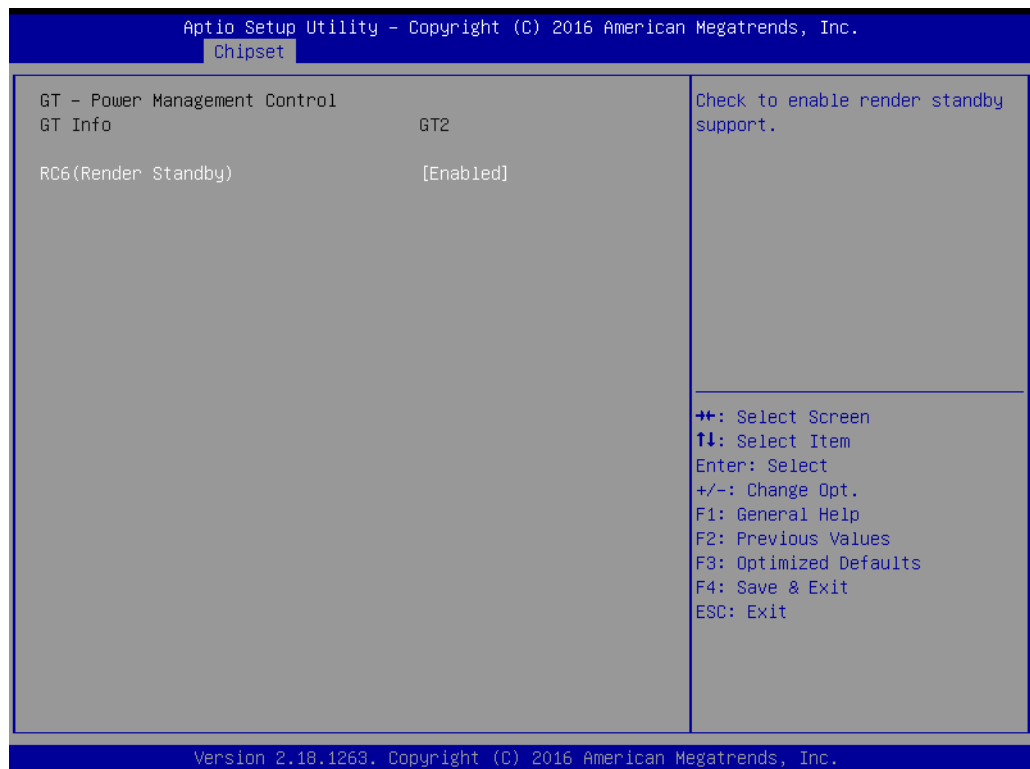

Figure 4.28 GT-Power Management Control settings

4.2.3.2 PCH-IO configuration

Display PCH Parameters

- **PCI Express configuration**
- **USB configuration**
- **HD Audio configuration**
- **LAN 1 Control [Enabled]: configure [Enabled][Disabled]**
- **LAN2 Control [Enabled]: configure [Enabled][Diabled]**
- **PCIE wake [Disabled]**
- **State After G3 [Power off]**

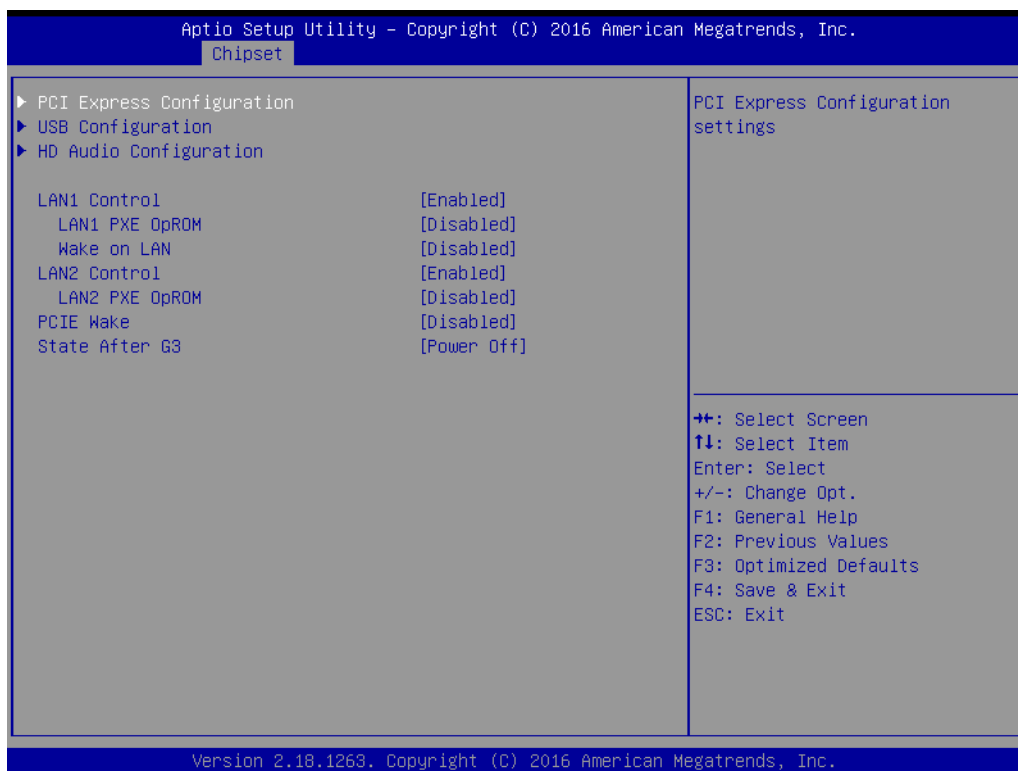

Figure 4.29 PCH-IO configuration setup

- **PCI Express Clock Gating [Enabled]:**
Enabled/ Disabled PCI Express clock gating for each root port; Configuration options: [Disabled][Enabled].
- **DMI Link ASPM Control [Enabled]:**
Enabled/ Disabled the control of active state power management on SA side of the DMI link; Configuration options: [Disabled].
- **PCIE Port 5 is assigned to LAN:**
Mini PCI Express.

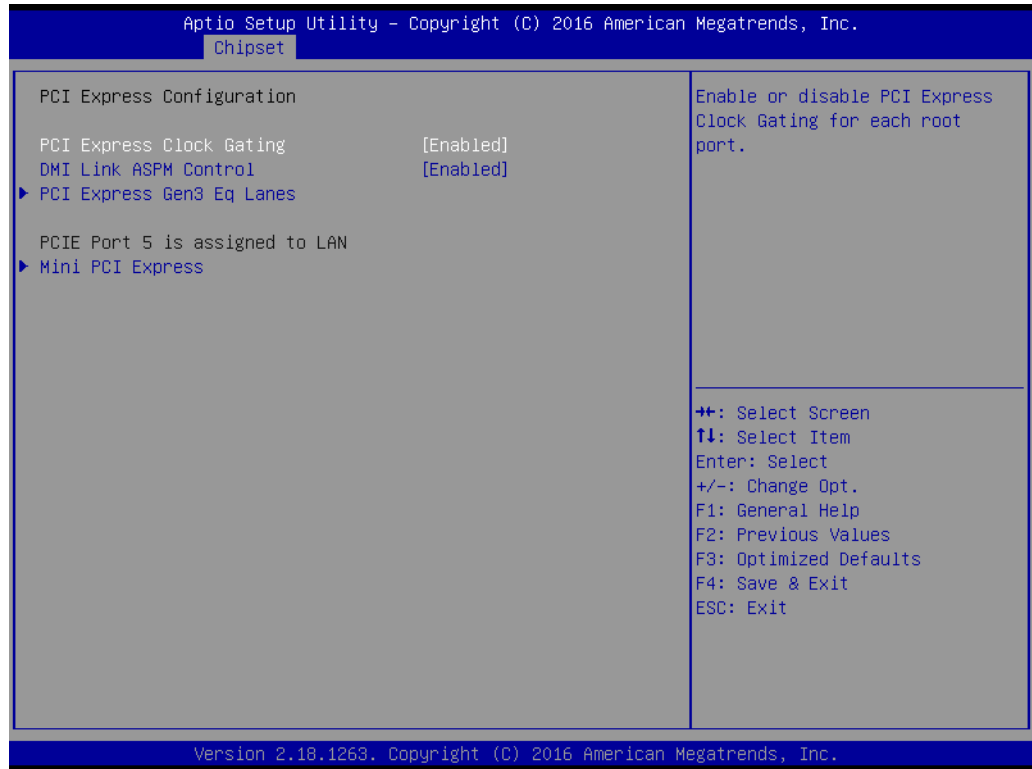

Figure 4.30 PCI Express configuration setup

- **PCI Express Gen3 Eq Lanes- Override SW EQ settings [Disabled]:**
Disabled/ Enabled Override SW EQ settings; Configuration options: [Disabled][Enabled].

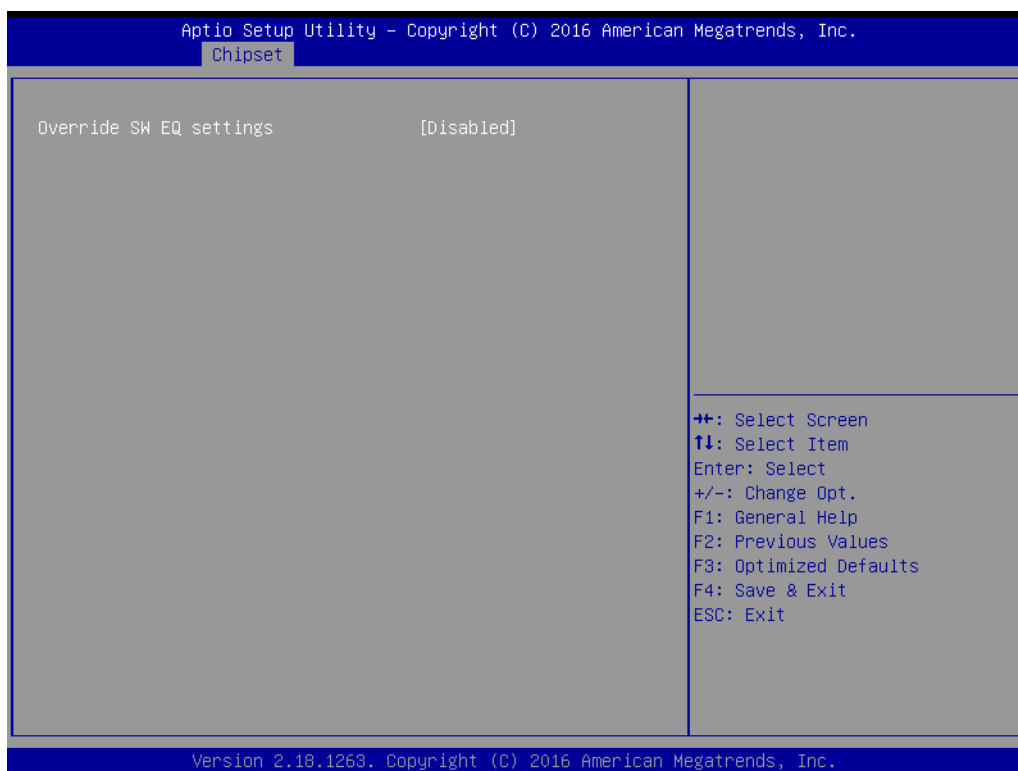

Figure 4.31 PCI Express Gen3 Eq Lanes setup

Mini PCI Express settings, and control the PCI Express Root Port.

- Mini PCI Express [Enabled]:
Enabled/ Disabled to control Mini PCI Express; Configuration options: [Disabled][Enabled][Auto]
- ASPM Support [Auto]
- L1 Substates [L1.1 & L1.2]
- Gen3 Eq Phase3 Method [Software Search]
- UPTP [5]
- DPTP [7]
- ACS [Enabled]
 - URR [Disabled]
 - FER [Disabled]
 - NFER [Disabled]
 - CER [Disabled]
 - CTO [Disabled]
 - SEFE [Disabled]
 - SECE [Disabled]
 - PME SCI [Enabled]
 - Advanced Error Reporting [Enabled]
- PCIe Speed [Auto]
- Detect Non-Compliance Device [Disabled]
- Extra Bus Reserved [0]
- Reserved Memory [10]

- Prefetchable Memory [10]
- Reserved I/O [4]
- PCIE Cp [2]
- PCIE Cm [6]
- PCIE LTR [Enabled]
- PCIE LTR Lock [Disabled]
- PCH PCIe CLKREQ# Configuration:
 PCIE10 CLKREQ Mapping Override [Default]
- Snoop Latency Ocerride [Auto]
- Non Snoop Latency Ocerride [Auto]

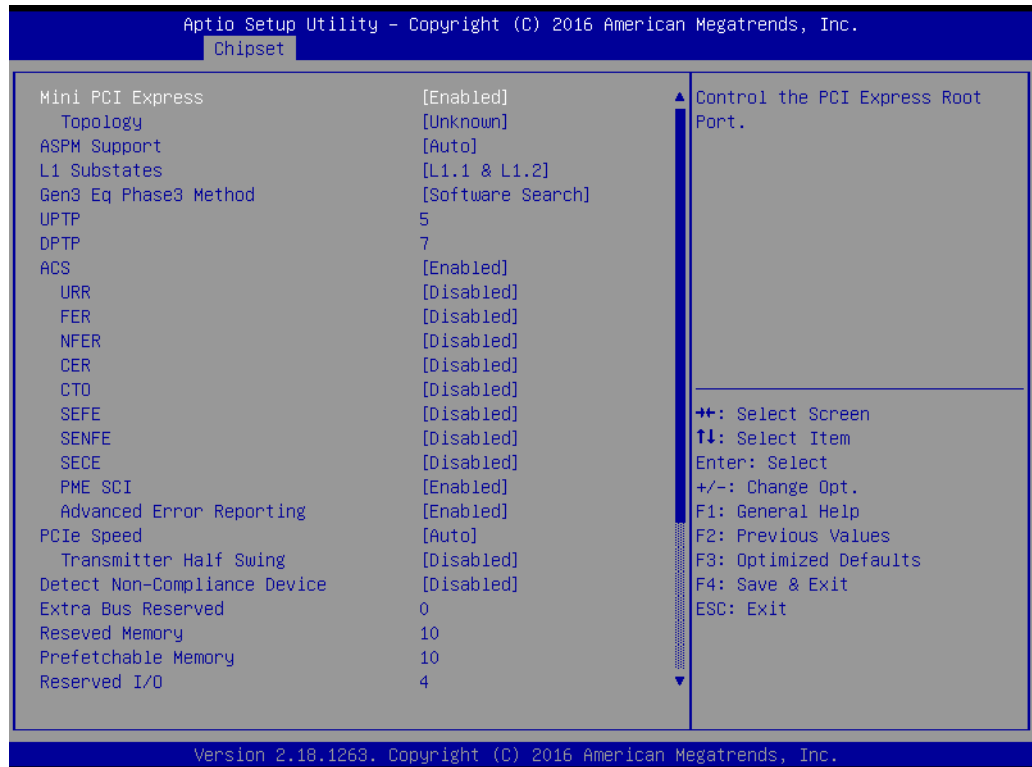

Figure 4.32 Mini PCI Express setup

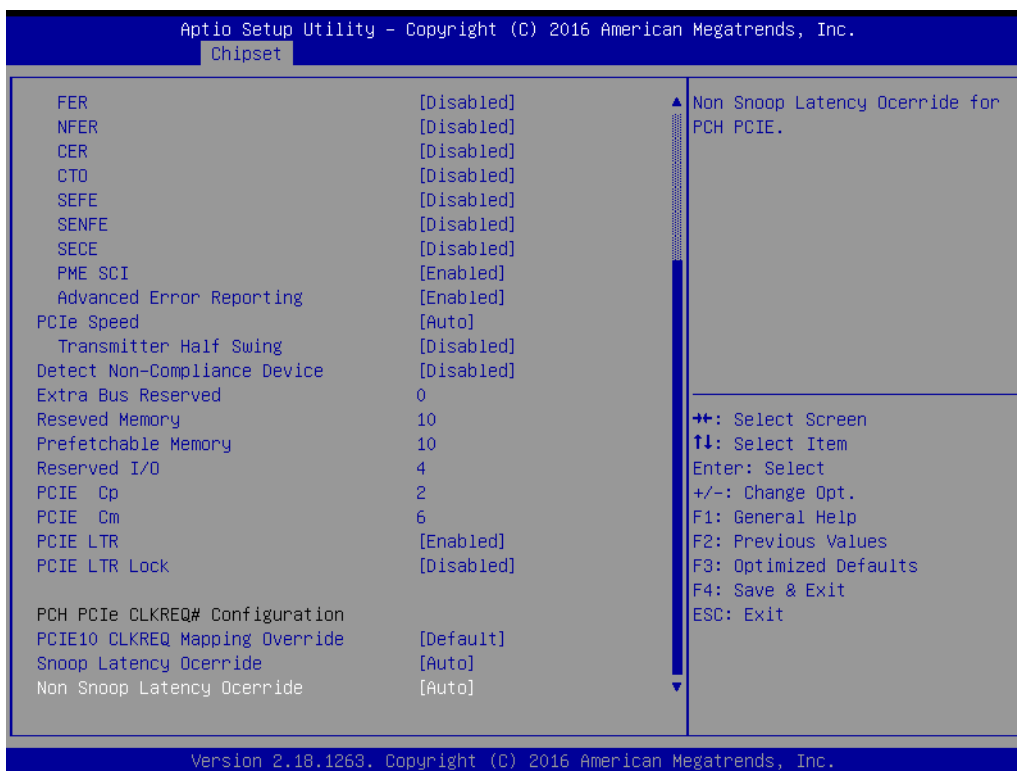

Figure 4.33 Mini PCI Express setup (continued)

- **Precondition work on USB host controller and root ports for faster enumeration.**
 - USB Precondition [Disabled]
 - XHCI Disable Compliance Mode [FALSE]
 - USB Port Disable Override [Disabled]

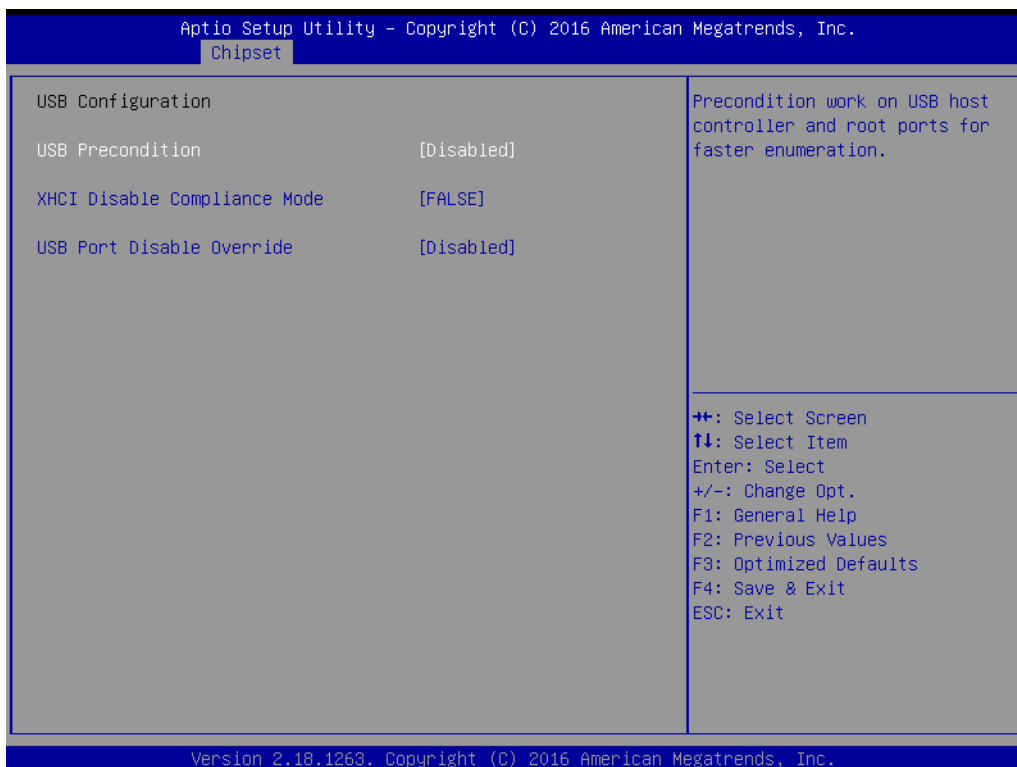

Figure 4.34 USB configuration setup

- **Control Detection of HD-Audio device [Auto]**
 - [Disabled] HDA will be unconditionally disabled.
 - [Enabled] HDA will be unconditionally enabled.
 - [Auto] HDA will be enabled if present, disabled otherwise.

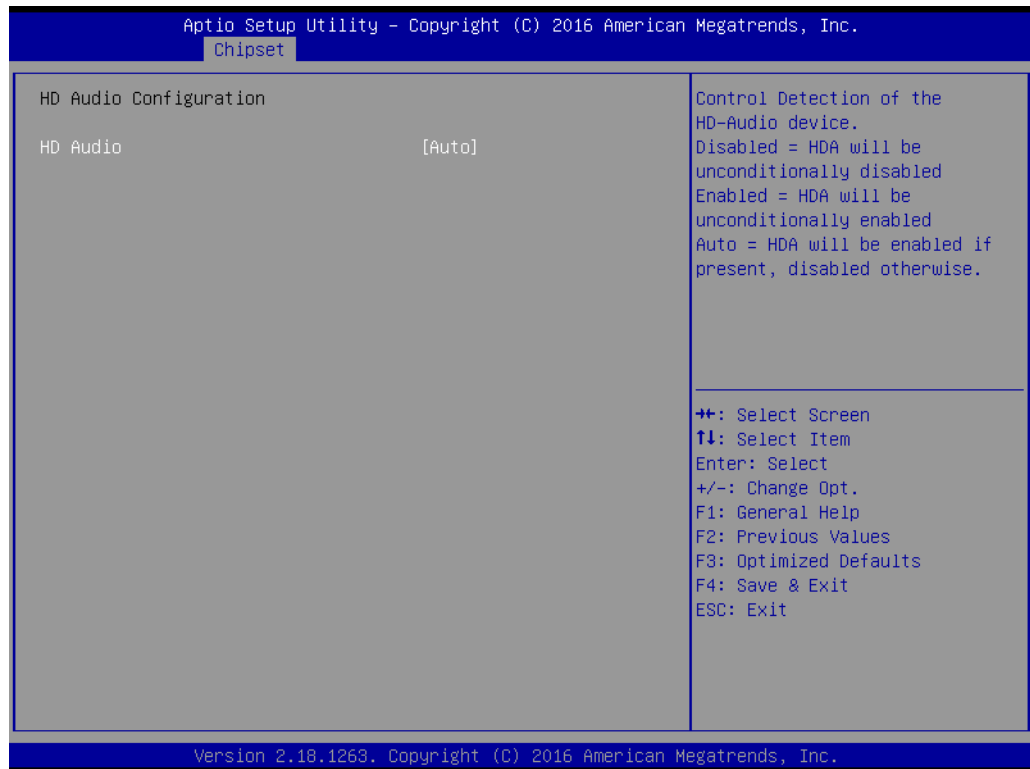

Figure 4.35 HD-Audio device setup

4.2.4 Security

- **Administrator Password:**
Set up Administrator password.
- **User Password:**
Set up User password.



Figure 4.36 Security screen

4.2.5 Boot

- **Setup Prompt Timeout [1]:**
Number of seconds to wait for setup to wait for setup activation key. 65535 (0xFFFF) means indefinite waiting.
- **Bootup NumLock State [On]:**
Select the keyboard NumLock State; Configuration options: [On][Off].
- **Quick Boot [Disabled]:**
Configuration options: [Disabled][Enabled].
- **Boot Option Priorities:**
Select the system boot order.
- **Fast Boot [Disabled]:**
Enabled/ Disabled boot with initialization of minimal set of devices required to launch active boot option. Has no effect for BBS boot options; Configuration options: [Disabled][Enabled].
- **New Boot Option Policy [Default].**

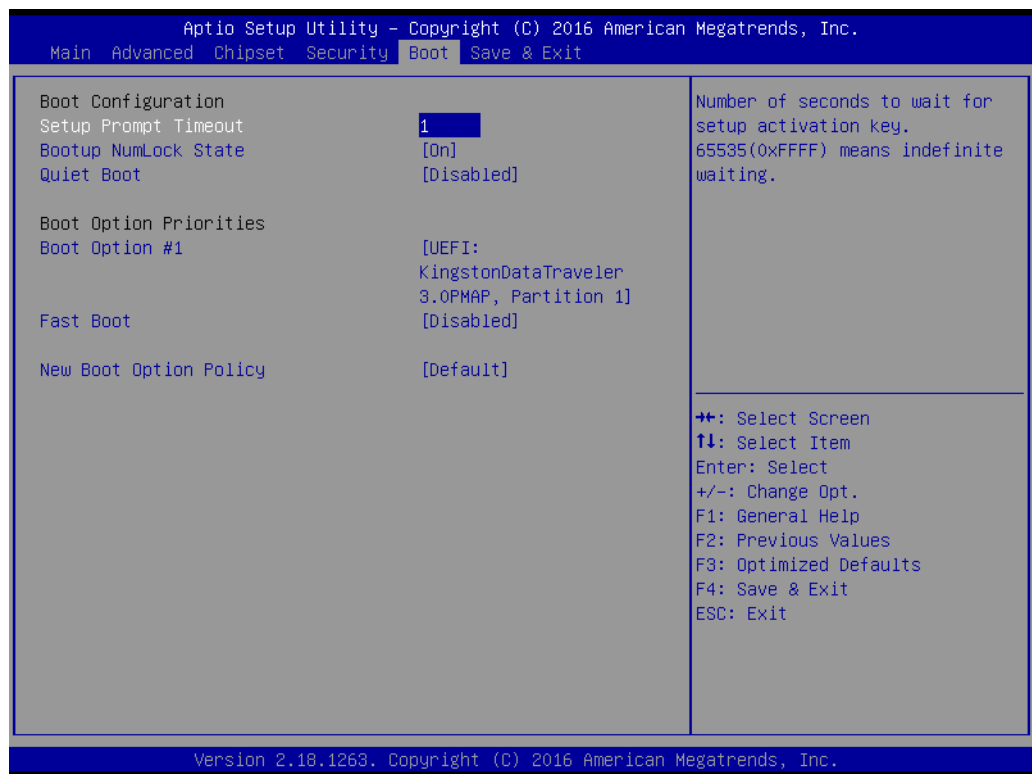

Figure 4.37 Boot setup

4.2.6 Save & Exit

- **Save Changes and Exit:**
Exit system setup after saving the changes.
- **Discard changes and Exit:**
Exit system setup without saving the changes.
- **Save changes and Reset:**
Reset the system after saving the changes.
- **Discard Changes and Reset:**
Reset the system without saving the changes.
- **Save Changes:**
Save changes done with any of the setup option.
- **Discard Changes:**
Discard changes done with any of the setup option.
- **Restore Defaults:**
Restore/ Load default values for all the setup option.
- **Save as User Defaults:**
Save the changes done as User Defaults.
- **Restore User Defaults:**
Restore the user defaults to all the setup options.

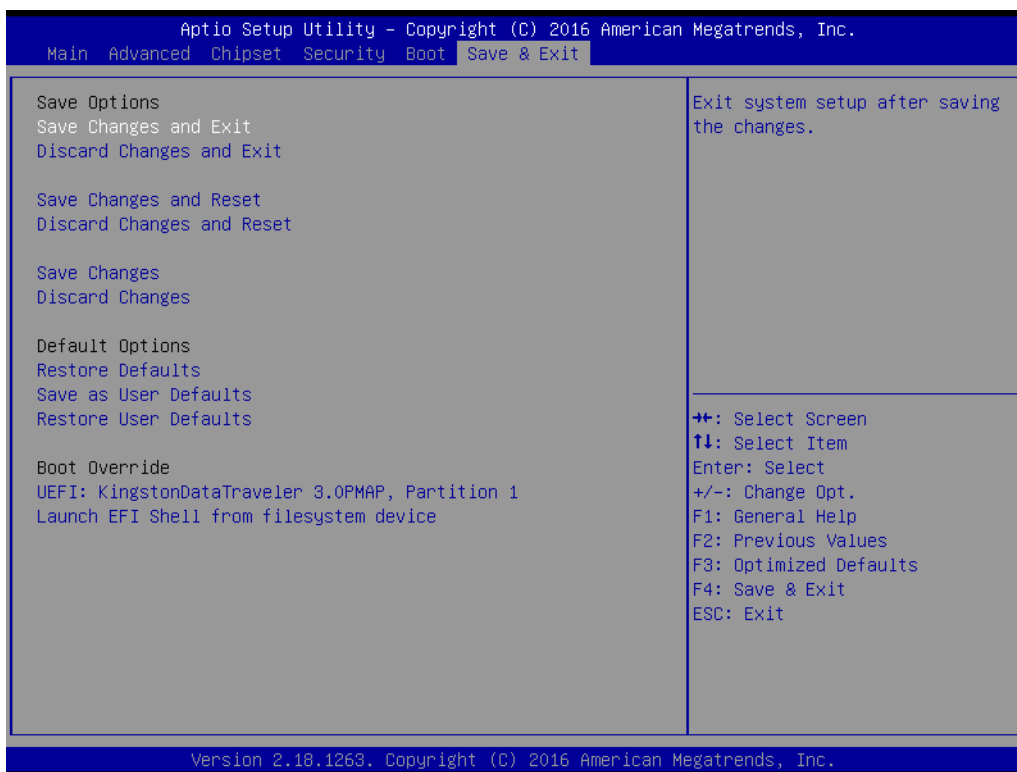

Figure 4.38 Save & Exit settings

ADVANTECH

Enabling an Intelligent Planet

www.advantech.com

Please verify specifications before quoting. This guide is intended for reference purposes only.

All product specifications are subject to change without notice.

No part of this publication may be reproduced in any form or by any means, such as electronically, by photocopying, recording, or otherwise, without the prior written permission of the publisher.

All brand and product names are trademarks or registered trademarks of their respective companies.

© Advantech Co., Ltd. 2017