

High Speed Fast Recovery Rectifier

A437

1500 Volts 600A Avg.

The A437 series is General Electric's highly reliable, all-diffused, Press-Pak, 600 ampere, fast recovery, silicon rectifier diode. These diodes are designed for use in high frequency applications or where a fast recovery diode is a necessity. These diodes provide a superior combination of speed, blocking voltage capability and soft recovery, which is required in such demanding applications as:

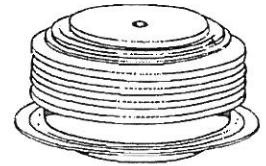

- Inverter Feedback Diode
- Free Wheeling Diode
- High Frequency Rectification
- Low EMI Power Supplies

FEATURES:

- Published Current Ratings Up To 20,000 Hz
- Soft Recovery With Low Recovered Charge
- All-Diffused
- Rugged Glazed Ceramic Hermetic Package With 1" Creepage Path
- Package Reversibility

MAXIMUM ALLOWABLE RATINGS AND SPECIFICATIONS

TYPES	REPETITIVE PEAK ¹ REVERSE VOLTAGE V_{RRM} $T_J = -40^{\circ}\text{C to } +125^{\circ}\text{C}$	NON-REPETITIVE ² PEAK REVERSE VOLTAGE, V_{RSM} $T_J = 25^{\circ}\text{C to } +125^{\circ}\text{C}$	DC REVERSE ³ VOLTAGE, V_R $T_J = -40^{\circ}\text{C to } +125^{\circ}\text{C}$	REPETITIVE PEAK REVERSE CURRENT, I_{RRM} $T_J = 125^{\circ}\text{C}$
A437A	100 Volts	200 Volts	100 Volts	50 mA
A437B	200	300	200	50
A437C	300	400	300	50
A437D	400	500	400	50
A437E	500	600	500	50
A437M	600	720	600	50
A437S	700	840	700	50
A437N	800	950	800	50
A437T	900	1075	900	50
A437P	1000	1200	1000	50
A437PA	1100	1300	1100	50
A437PB	1200	1400	1200	50
A437PC	1300	1500	1300	50
A437PD	1400	1600	1400	50
A437PE	1500	1700	1500	50

Peak Forward Current, I_{FM} ($T_C = +65^{\circ}\text{C}$, Half Sine Wave Pulse Base Width = 8.3 msec., D.F. 50%) 1,700 Amperes
 Peak One-Cycle Surge (Non-Repetitive), Forward Current, I_{FSM} 10,000 Amperes
 Minimum I^2t Rating (See Curve 11), $t \geq 1$ msec. (Non-Repetitive) 105,000 (RMS Ampere)² Seconds
 Thermal Resistance, $R_{\theta JC}$ (D.C.)06°C/Watt
 Storage Temperature, T_{stg} -40°C to +150°C
 Operating Junction Temperature, T_J -40°C to +125°C
 Mounting Force Required 2000 Lbs \pm 10%
8.9KN \pm 10%

NOTES:

- ¹ Assumes a heatsink thermal resistance of less than 2.0°C/watt.
- ² Non-repetitive voltage and current ratings, as contrasted to repetitive ratings, apply for occasional or unpredictable overloads. For example, the forward surge current ratings are non-repetition ratings that are used in fault coordination work.
- ³ Assumes a heatsink thermal resistance of less than 1.0°C/watt.

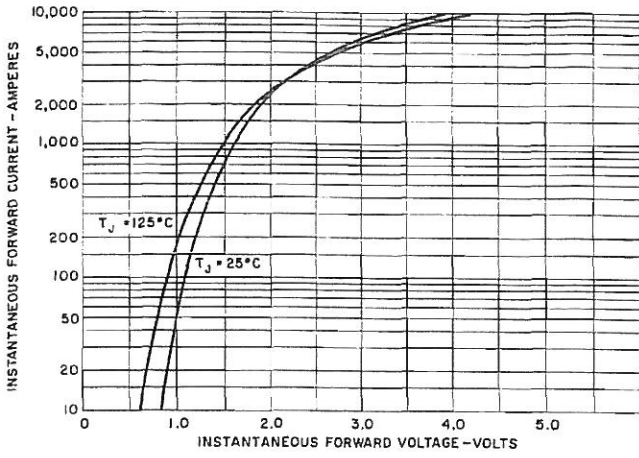

1. MAXIMUM FORWARD CHARACTERISTICS

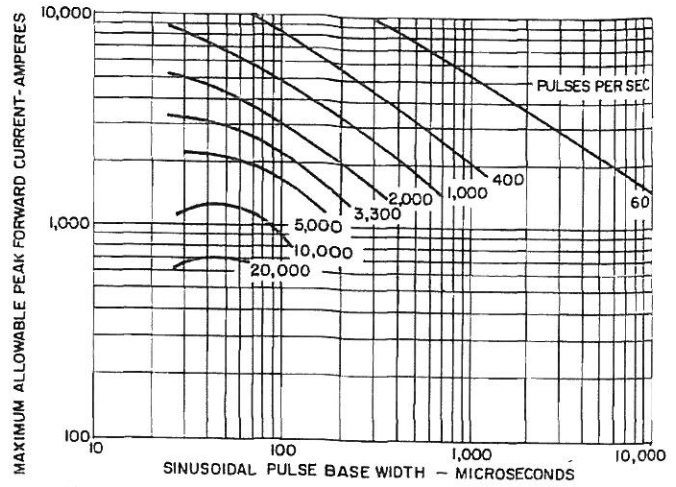

2. MAXIMUM ALLOWABLE PEAK FORWARD CURRENT SINUSOIDAL WAVEFORM ($T_C = 65^\circ\text{C}$) DOUBLE SIDE COOLED

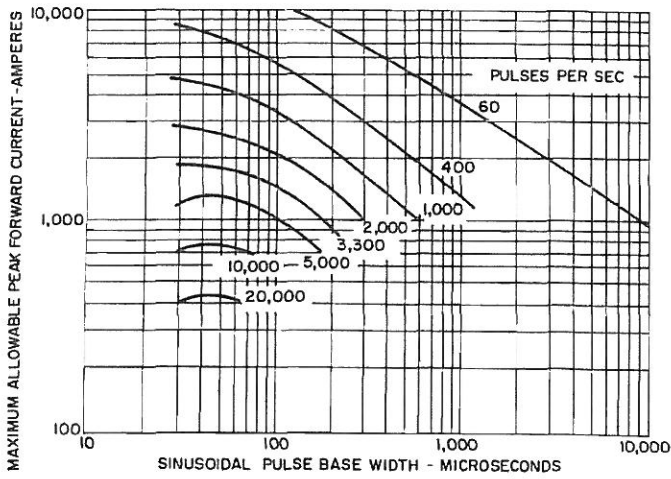

3. MAXIMUM ALLOWABLE PEAK FORWARD CURRENT SINUSOIDAL WAVEFORM ($T_C = 90^\circ\text{C}$) DOUBLE SIDE COOLED

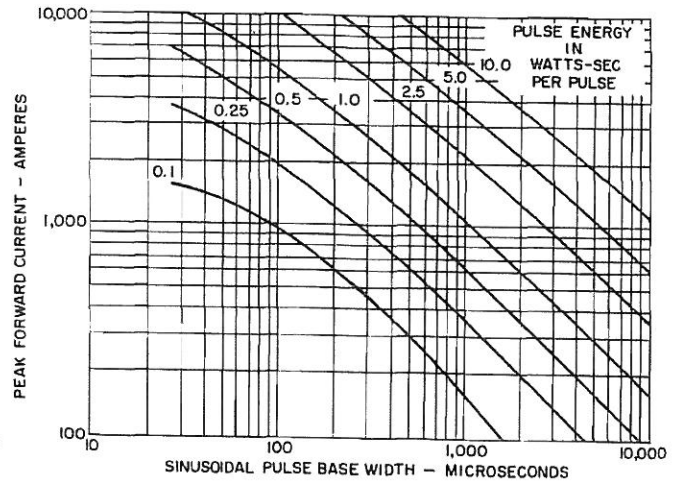

4. SINUSOIDAL PULSE ENERGY ($T_J = 125^\circ\text{C}$)

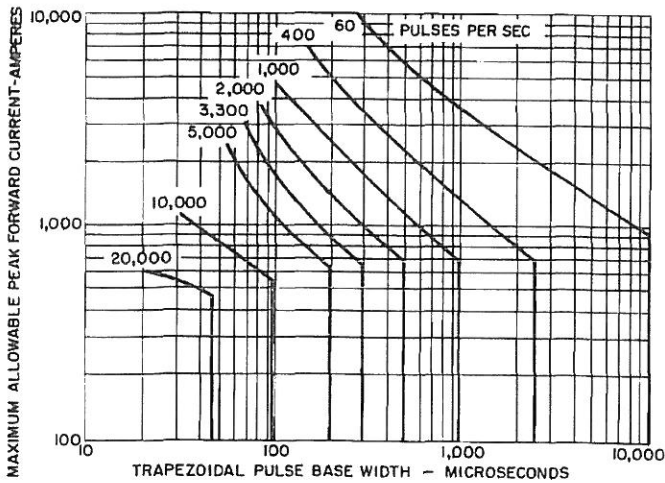

5. MAXIMUM ALLOWABLE PEAK FORWARD CURRENT, TRAPEZOIDAL WAVEFORM ($T_C = 65^\circ\text{C}$) DOUBLE SIDE COOLED dI/dT (RISING & FALLING) = 100 A/ μS

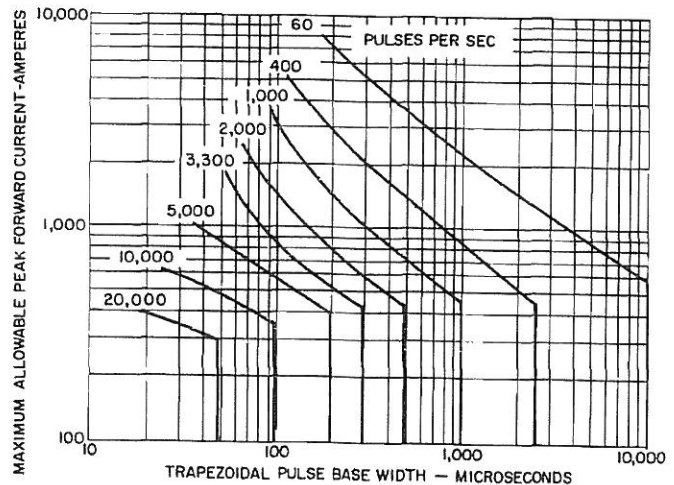

6. MAXIMUM ALLOWABLE PEAK FORWARD CURRENT, TRAPEZOIDAL WAVEFORM ($T_C = 90^\circ\text{C}$) DOUBLE SIDE COOLED

DEVICE SPECIFICATIONS

A437

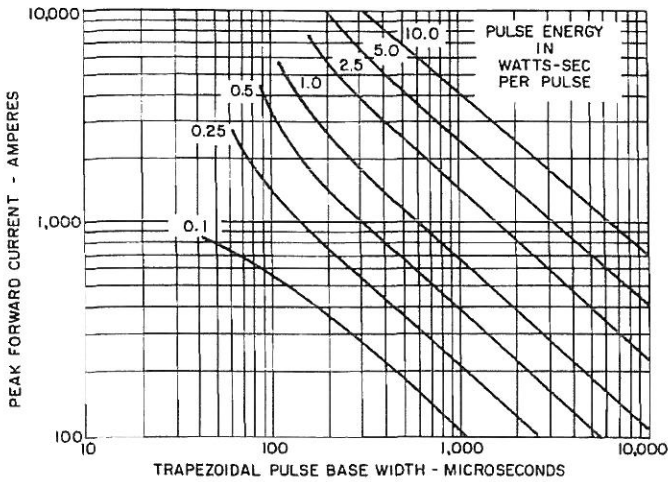

7. TRAPEZOIDAL PULSE ENERGY DI/DT (RISING & FALLING) = 100 A/ μ S ($T_J = 125^\circ\text{C}$)

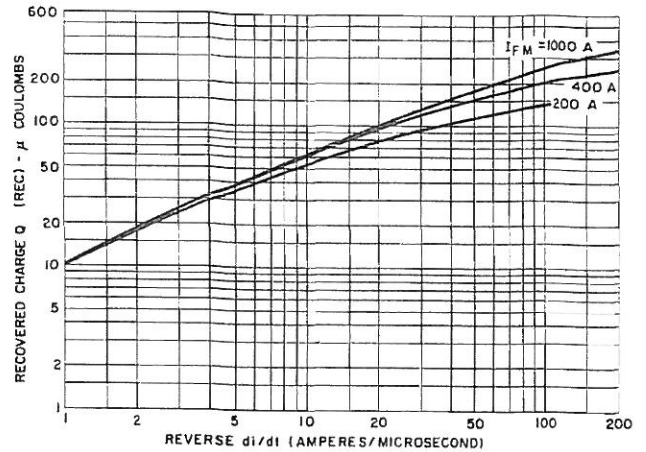

8. MAXIMUM RECOVERED CHARGE ($T_J = 125^\circ\text{C}$)

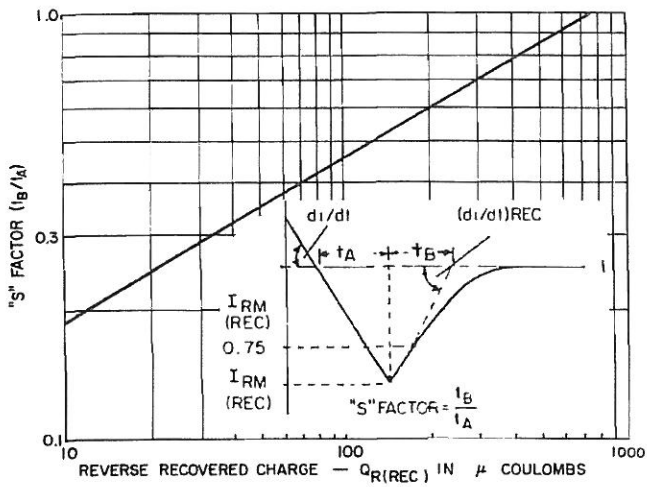

9. TYPICAL "S" FACTOR VERSUS RECOVERY CHARGE ($T_J = 125^\circ\text{C}$)

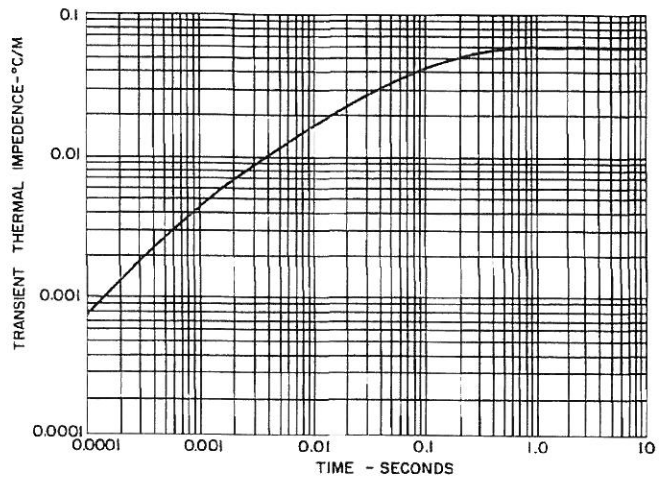

10. TRANSIENT THERMAL IMPEDANCE - JUNCTION-TO-CASE, DOUBLE SIDE COOLED

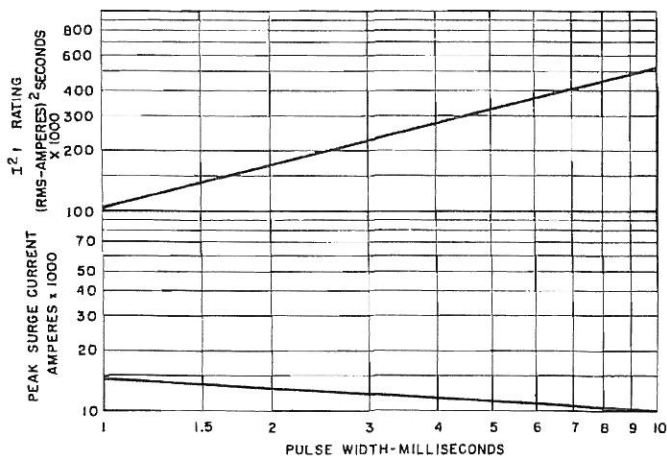

11. SUB-CYCLE SURGE FORWARD CURRENT AND I^2t RATINGS VERSUS PULSE TIME FOLLOWING RATED LOAD CONDITIONS

OUTLINE DRAWING

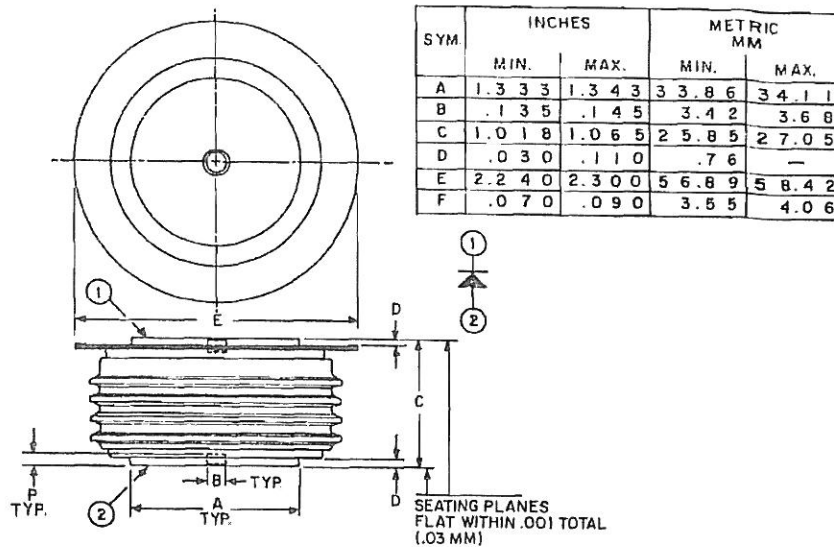

MOUNTING INSTRUCTIONS

The General Electric Company offers the Series 2500, Press Pak, mounting clamp designed to facilitate single- or double-side cooling of all GE Press pak's.

Special features of this clamp:

- Metal pivot insuring constant pressure in rugged applications over long periods.
- One-piece phenolic insulator gives 1" nominal creep distance.
- Use of special *Force Indicator Gauge* eliminates need for torque wrenches, inaccurate "flex" gauges, and *guesswork*.
- Various bolt lengths available to accommodate most mounting situations.
- No loose parts to complicate assembly.
- Stiffening *brace* to reinforce heat sink *available upon request*.
- *Single-side cooling terminal available upon request*.
- Positive, non-binding swivel action.

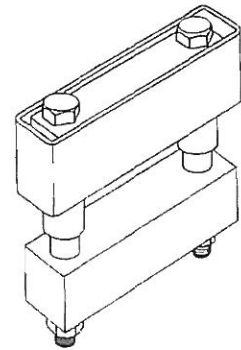

SUGGESTED MOUNTING METHODS FOR PRESS-PAKS TO HEAT DISSIPATORS

When the Press-Pak is assembled to a heat sink in accordance with the following general instructions, a reliable and low thermal resistance interface will result:

1. Check each mating surface for nicks, scratches, flatness and surface finish. The heat dissipator mating surfaces should be flat within .0005 inch/inch and have a surface finish of 63 micro-inches.
2. It is recommended that the heat dissipator mounting surfaces be plated with nickel, tin or silver. Bare aluminum or copper surfaces will oxidize in time resulting in excessively high thermal resistance.
3. Sand each surface *lightly* with 600 grit paper just prior to assembly. Clean off and apply silicone oil (GE SF1154 200 centistoke viscosity) or silicone grease (GE G322L or Dow Corning DC 3, 4, 340 or 640). Clean off and apply again as a *thin* film. (A thick film will adversely affect the electrical and thermal resistances.)
4. Assemble with the specified mounting force applied through a self-leveling, swivel connection. The force has to be evenly distributed over the full area. Center holes on both top and bottom of the Press-Pak are for locating purposes only.

5.2 Condensed Electrical and Thermal Characteristics and Ratings



109.1

RECTIFIERS 600 TO 1000 AMPERES



182



183

JEDEC TYPE	—	—	—	—	—
GE TYPE	A437	A337	A500	A433	A430

SPECIFICATIONS

$I_{FM(AV)}$	Max. average forward (1 phase operation)	600	650	750	750	1000	
	$T_C = (^{\circ}C)$	65	65	100	83	113	
V_{RM} (Rep)	Max. repetitive peak reverse voltage (V)	100-1500	100-1500	1600-3000	1600-3200	100-1500	
I_{FM} (Surge)	Max. peak one cycle, non-recurrent surge current (1 phase operation) 50 Hz.	9000	9000	9000	9500	9500	
	@ max. rated load conditions (A) 60 Hz.	10000	10000	10000	10000	10000	
I^2t	Max. non-repetitive for 1.5 msec ($A^2 \cdot sec$)	140,000	140,000	200,000	200000	200000	
T_J	Operating junction temperature range ($^{\circ}C$)	-40 to 125	-40 to 125	-40 to 175	-40 to 200	-40 to 200	
$R_{\theta JC}$	Max. thermal resistance, junction-to-case ($^{\circ}C/W$)	.06	.045	.06	.06	.06	
V_{FM}	Max. peak forward voltage drop @ rated $I_{F(AV)}$ (1 phase operation)	2.0	1.9	1.25	1.7	1.55	
	@ $T_C = (^{\circ}C)$	25	25	25	25	25	
$Q_{R(REC)}$	Reverse recovered charge @ rated T_J (μC)	100	100	—	2000	—	
t_{rr}	Reverse recovery time @ rated T_J (μs)	3.5	3.5	—	12	—	
V_F	Max. forward ⁽¹⁾ voltage drop for the current range:	$I_{MIN}(A)$	10	10	10	200	10
		$I_{MAX}(A)$	9000	9000	8000	10000	7000
		A	.348	.348	-.13	0.102	.38
		B	.1	.1	.22	0.192	.04
		C	.0002	.0002	.0006	.00067	.0002
$R_{\theta JC}$	Transient thermal ⁽²⁾ resistance for time:	$T_{MIN}(S)$.001	.001	.001	.001	.001
		$T_{MAX}(S)$.01	.01	.1	.01	.01
		F	.33	.33	.05	0.29	.32
		G	.63	.63	.42	0.61	.6
		Package Outline No.		183	109.1	182	183
Max Mounting Force (Lbs/Kn)		2000/8.9	2000/8.9	2200/9.8	2000/8.9	2000/8.9	
Expanded Electrical Characterization, see page:		168	155	N.A.	167	164	

⁽¹⁾Voltage Drop Model: $V_F = A + B \cdot L_N(I) + C \cdot I + D \cdot \sqrt{I}$

⁽²⁾Transient Thermal Resistance Model: $R_{\theta JC} = F \cdot t^G$